

**2SC1570,
1571,
1571L**



2003A

NPN Epitaxial Planar Silicon Transistors

T-29-15

Very Low Noise Amp Applications

©431D

The 2SC1570, 1571, 1571L are developed as very low-noise transistors and are especially suited for use in equalizer first stage of high-grade type stereo sets.

Absolute Maximum Ratings at Ta=25°C		2SC1570	2SC1571	2SC1571L	unit
Collector to Base Voltage	V _{CB0}	55	40	40	V
Collector to Emitter Voltage	V _{CE0}	50	35	35	V
Emitter to Base Voltage	V _{EBO}		5		V
Collector Current	I _C		100		mA
Allowable Power Dissipation	P _C		200		mW
Junction Temperature	T _J		125		°C
Storage Temperature	T _{stg}		-55 to +150		°C

Electrical Characteristics at Ta=25°C		min	typ	max	unit
Collector Cutoff Current	I _{CB0} V _{CB} =18V, I _E =0			0.1	uA
Emitter Cutoff Current	I _{EBO} V _{EB} =3V, I _C =0			0.1	uA
DC Current Gain	h _{FE} V _{CE} =6V, I _C =1mA	160*		960*	
Gain Bandwidth Product	f _T V _{CE} =6V, I _C =1mA		100		MHz
Output Capacitance	c _{ob} V _{CB} =6V, f=1MHz		3		pF
C-E Saturation Voltage	V _{CE(sat)} I _C =50mA, I _B =5mA			0.5	V
Base to Emitter Voltage	V _{BE} V _{CE} =2V, I _C =1mA	0.58	0.80		V
C-B Breakdown Voltage	V(BR)CBO I _C =10uA, I _B =0				V
				[C1570] 55	
				[C1571, 1571L] 40	
C-E Breakdown Voltage	V(BR)CEO I _C =1mA, R _{BE} =∞				V
				[C1570] 50	
				[C1571, 1571L] 35	
E-B Breakdown Voltage	V(BR)EBO I _E =10uA, I _C =0			5	V
Noise Voltage	at test circuit [C1570, 1571]			40	mV
	V _{CC} =30V, I _C =1mA [C1571L]			65	mV
	R _g =56kohm, V _G =77dB (at 1kHz)				
Noise Peak Level	" " [C1570, 1571]			280	mV
	" " [C1571L]			450	mV

*:The 2SC1570, 1571, 1571L are classified by 1mA h_{FE} as follows:

160	F	320	280	G	560	480	H	960
-----	---	-----	-----	---	-----	-----	---	-----

Noise Test Circuit

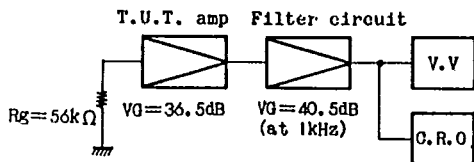

Case Outline 2003A (unit:mm)

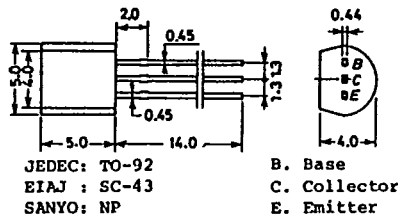

2SC1570, 1571, 1571L

(T-29-15)

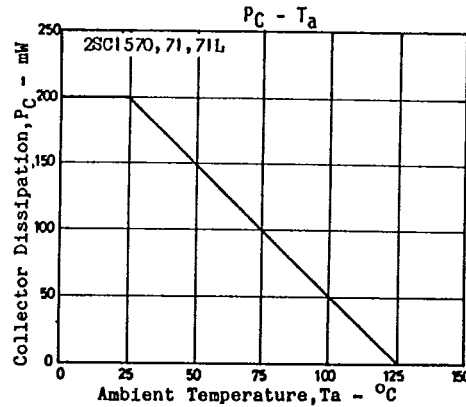
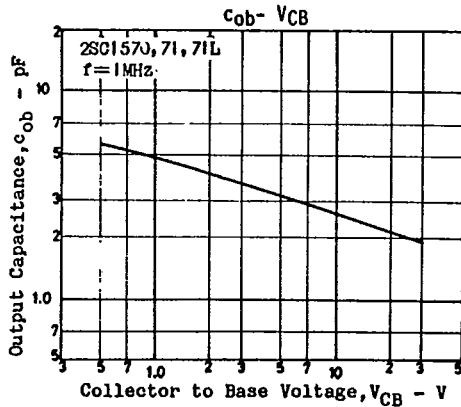
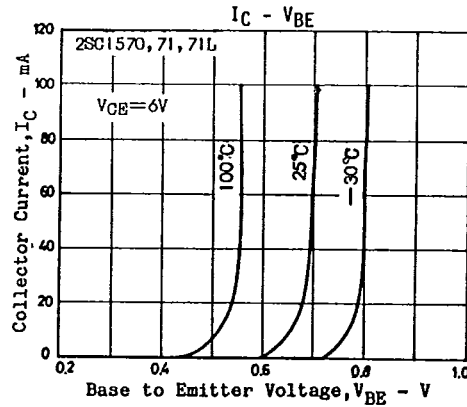
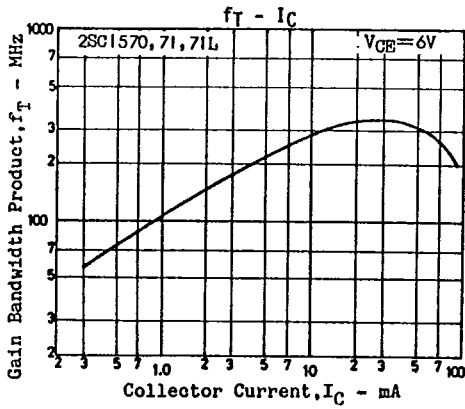
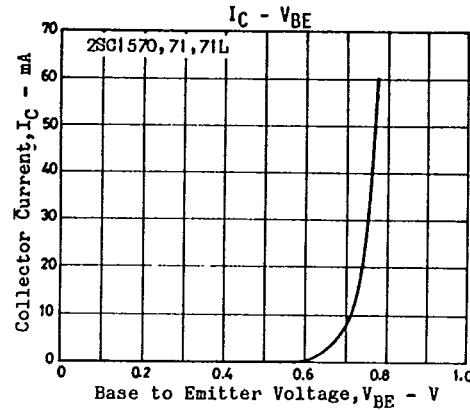
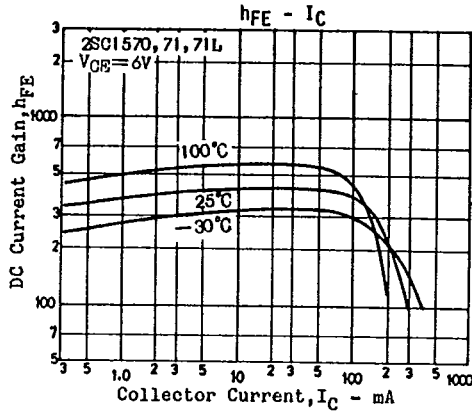
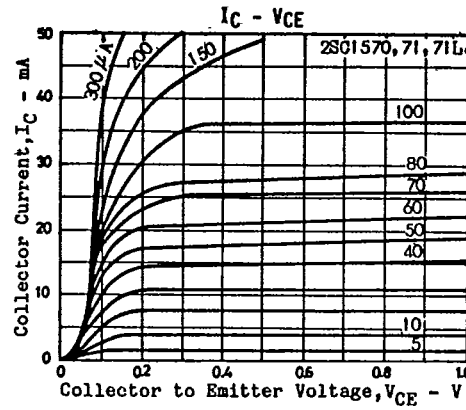
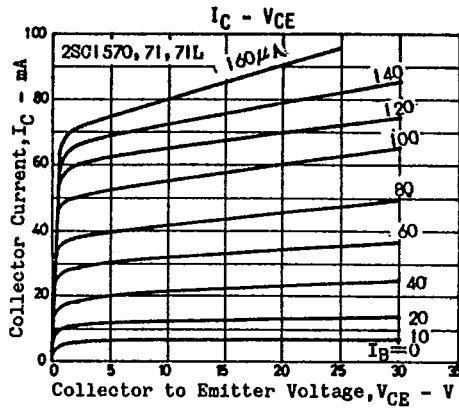

2SC1570, 1571, 1571L

(T-29-15)

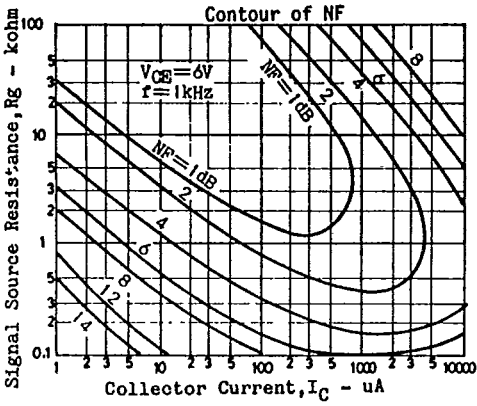
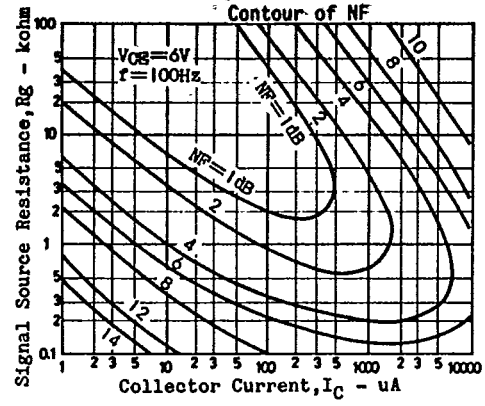
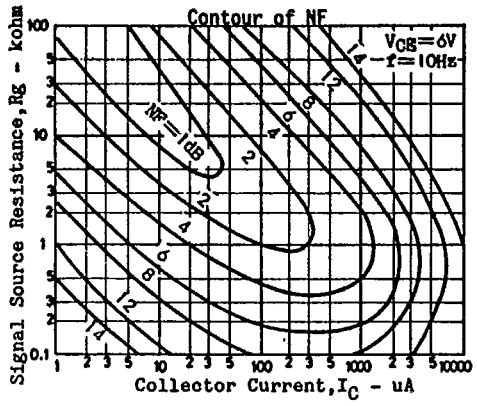

T-91-20

CASE OUTLINES AND ATTACHMENTS

- All of Sanyo Transistor case outlines are illustrated below.
- All dimensions are in mm, and dimensions which are not followed by min. or max. are represented by typical values.
- No marking is indicated.

Case Outline-[2003A]

unit:mm

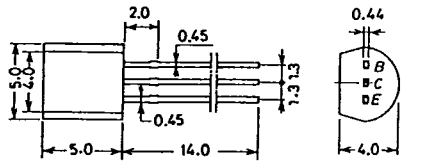

JEDEC: TO-92
EIAJ: SC-43
SANYO: NP

B. Base
C. Collector
E. Emitter

Case Outline-[2009A]

unit:mm

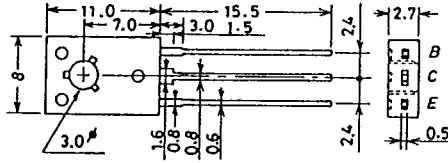

JEDEC: TO-126

B: Base
C: Collector
E: Emitter

Case Outline-[2004A]

unit:mm

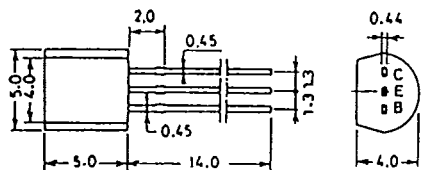

JEDEC: TO-92
EIAJ: SC-43
SANYO: NP

C. Collector
E. Emitter
B. Base

Case Outline-[2010A]

unit:mm

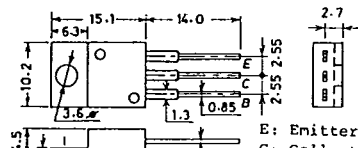

JEDEC: TO-220AB
EIAJ: SC-46

E: Emitter
C: Collector
B: Base

Case Outline-[2005A]

unit:mm

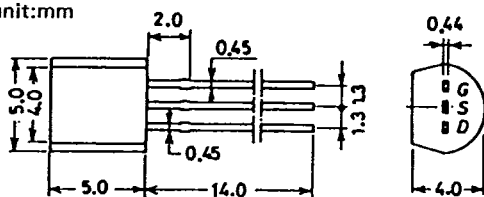

JEDEC: TO-92
EIAJ: SC-43
SANYO: NP

G: Gate
S: Source
D: Drain
B: Base
C: Collector

Case Outline-[2012]

unit:mm

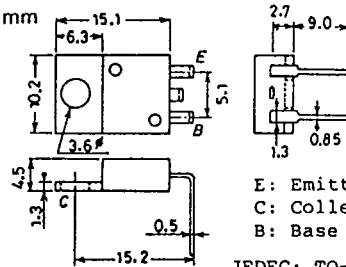

JEDEC: TO-220AA
EIAJ: SC-45

E: Emitter
C: Collector
B: Base

Case Outline-[2006A]

unit:mm

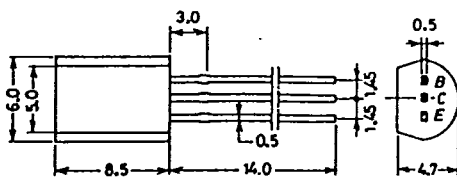

EIAJ: SC-51
SANYO: MP

B: Base
C: Collector
E: Emitter

Case Outline-[2013]

unit:mm

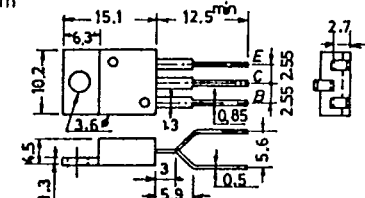

JEDEC TO-220

B: Base
C: Collector
E: Emitter

T-91-20

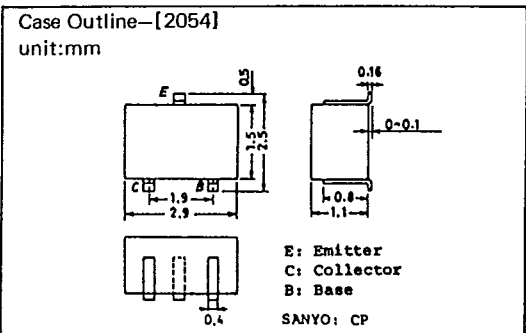
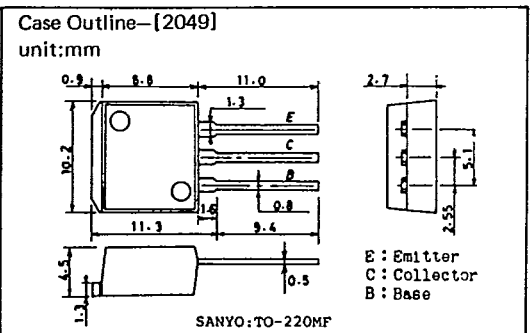
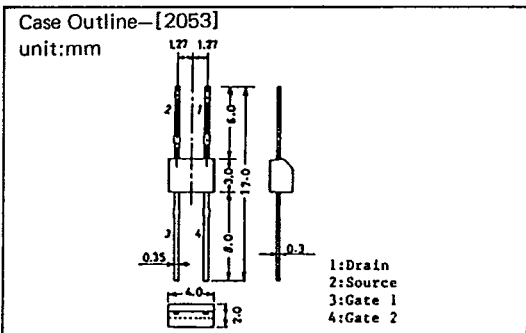
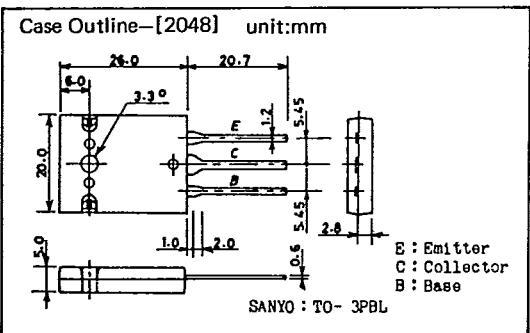
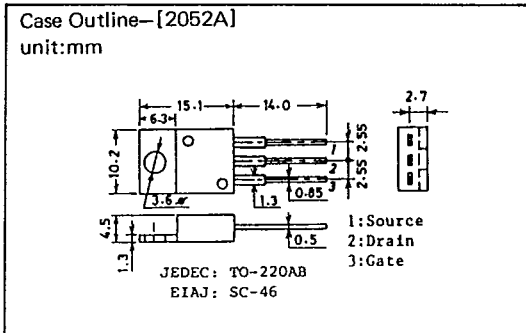
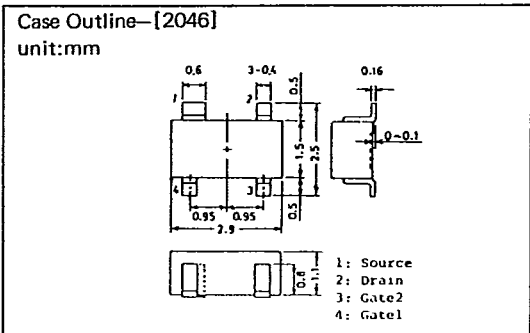
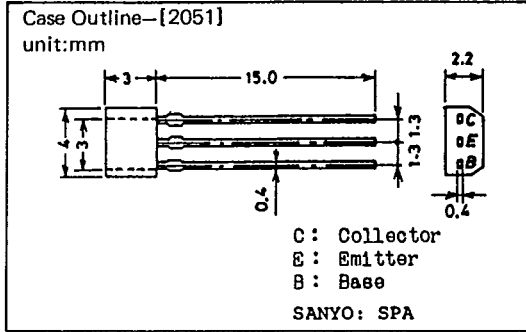
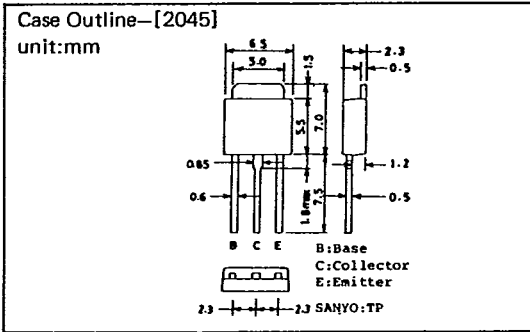
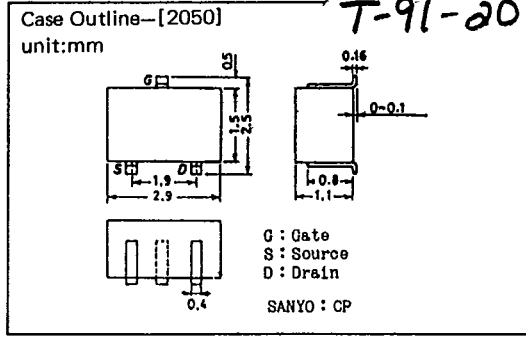
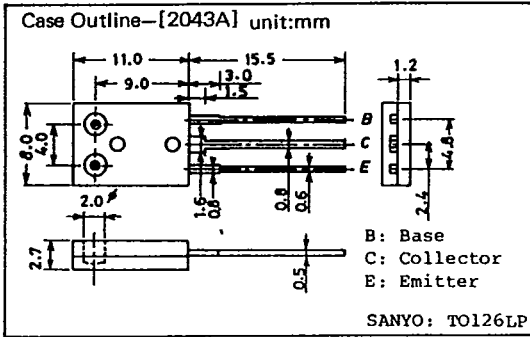

T-91-20

