

## NPN Silicon Darlington Transistors

**BC 617**  
**BC 618**

- High current gain
- High collector current

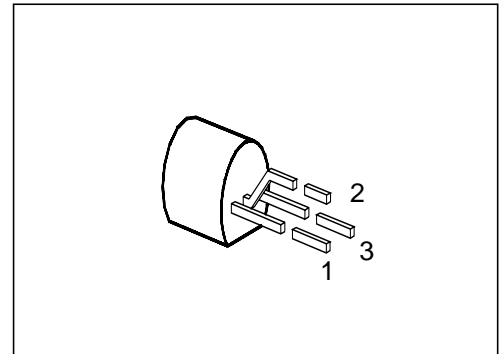

Type	Marking	Ordering Code	Pin Configuration			Package <sup>1)</sup>
			1	2	3	
BC 617 BC 618	–	Q62702-C1137 Q62702-C1138	C	B	E	TO-92

### Maximum Ratings

Parameter	Symbol	Values		Unit
		BC 617	BC 618	
Collector-emitter voltage	$V_{CE0}$	40	55	V
Collector-base voltage	$V_{CB0}$	50	80	
Emitter-base voltage	$V_{EB0}$	12		
Collector current	$I_C$	500		mA
Peak collector current	$I_{CM}$	800		
Base current	$I_B$	100		
Peak base current	$I_{BM}$	200		
Total power dissipation, $T_c = 66\text{ °C}$	$P_{tot}$	625		mW
Junction temperature	$T_j$	150		°C
Storage temperature range	$T_{stg}$	– 65 ... + 150		

### Thermal Resistance

Junction - ambient	$R_{th JA}$	≤ 200	K/W
Junction - case <sup>2)</sup>	$R_{th JC}$	≤ 135	

<sup>1)</sup> For detailed information see chapter Package Outlines.

<sup>2)</sup> Mounted on Al heat sink 15 mm × 25 mm × 0.5 mm.

## Electrical Characteristics

at  $T_A = 25\text{ °C}$ , unless otherwise specified.

Parameter	Symbol	Values			Unit
		min.	typ.	max.	

### DC characteristics

Collector-emitter breakdown voltage $I_C = 10\text{ mA}$	$V_{(BR)CE0}$				V
BC 617		40	–	–	
BC 618		55	–	–	
Collector-base breakdown voltage $I_C = 100\text{ }\mu\text{A}$	$V_{(BR)CB0}$				
BC 617		50	–	–	
BC 618		80	–	–	
Emitter-base breakdown voltage $I_E = 10\text{ }\mu\text{A}$	$V_{(BR)EB0}$	12	–	–	
Collector cutoff current $V_{CB} = 40\text{ V}$	$I_{CB0}$				nA
BC 617		–	–	100	
$V_{CB} = 60\text{ V}$	BC 618	–	–	100	nA
$V_{CB} = 40\text{ V}, T_A = 150\text{ °C}$	BC 617	–	–	10	$\mu\text{A}$
$V_{CB} = 60\text{ V}, T_A = 150\text{ °C}$	BC 618	–	–	10	$\mu\text{A}$
Emitter cutoff current $V_{EB} = 4\text{ V}$	$I_{EB0}$	–	–	100	nA
DC current gain $I_C = 100\text{ }\mu\text{A}; V_{CE} = 5\text{ V}$	$h_{FE}$				–
BC 617		4000	–	–	
BC 618		2000	–	–	
$I_C = 10\text{ mA}; V_{CE} = 5\text{ V}^{1)}$	BC 617	10000	–	–	
BC 618		4000	–	–	
$I_C = 200\text{ mA}; V_{CE} = 5\text{ V}^{1)}$	BC 617	20000	–	70000	
BC 618		10000	–	50000	
$I_C = 1000\text{ mA}; V_{CE} = 5\text{ V}^{1)}$	BC 617	10000	–	–	
BC 618		4000	–	–	
Collector-emitter saturation voltage <sup>1)</sup> $I_C = 200\text{ mA}; I_B = 0.2\text{ mA}$	$V_{CEsat}$	–	–	1.1	V
Base-emitter saturation voltage <sup>1)</sup> $I_C = 200\text{ mA}; I_B = 0.2\text{ mA}$	$V_{BEsat}$	–	–	1.6	

<sup>1)</sup> Pulse test:  $t \leq 300\text{ }\mu\text{s}, D \leq 2\text{ %}$ .

## Electrical Characteristics

at  $T_A = 25\text{ }^\circ\text{C}$ , unless otherwise specified.

Parameter	Symbol	Values			Unit
		min.	typ.	max.	

### AC characteristics

Transition frequency $I_C = 50\text{ mA}$ , $V_{CE} = 5\text{ V}$ , $f = 20\text{ MHz}$	$f_t$	–	150	–	MHz
Output capacitance $V_{CB} = 10\text{ V}$ , $f = 1\text{ MHz}$	$C_{obo}$	–	3.5	–	pF

### Total power dissipation $P_{tot} = f(T_A; T_C)$

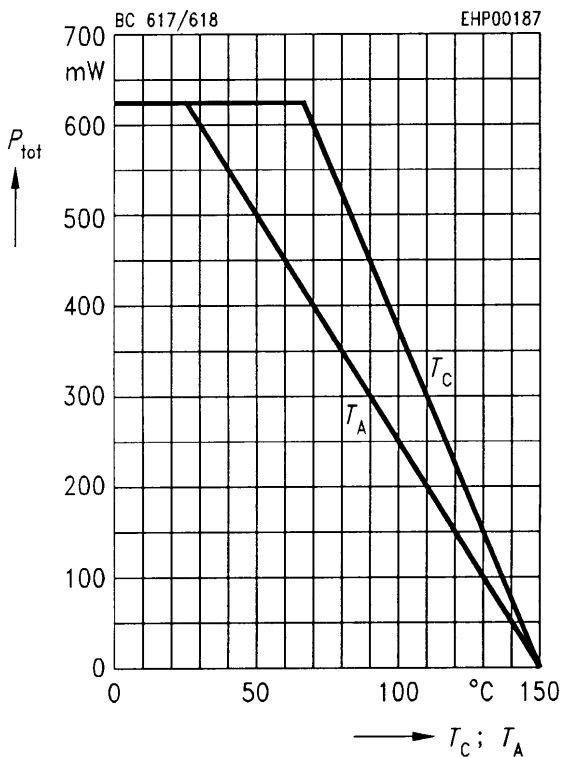

### Collector cutoff current $I_{CBO} = f(T_A)$

$V_{CB} = 40\text{ V}$ ,  $60\text{ V}$

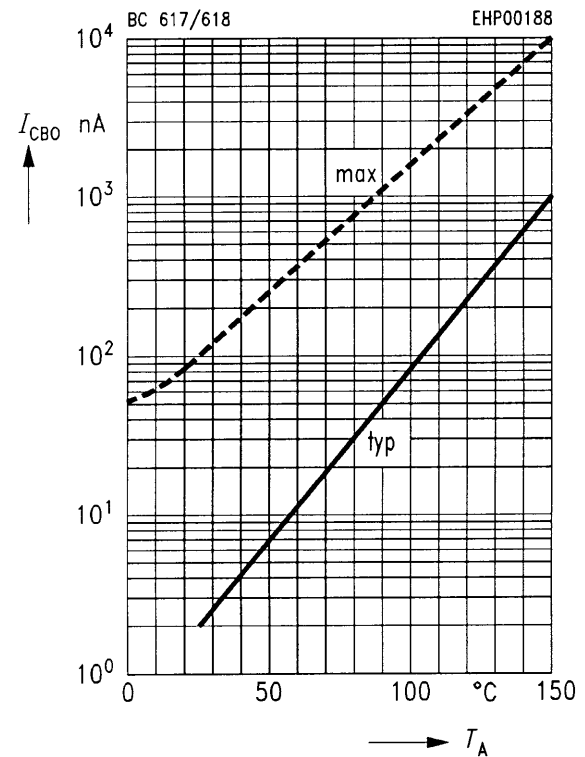

**Permissible pulse load  $R_{thJA} = f(t_p)$**

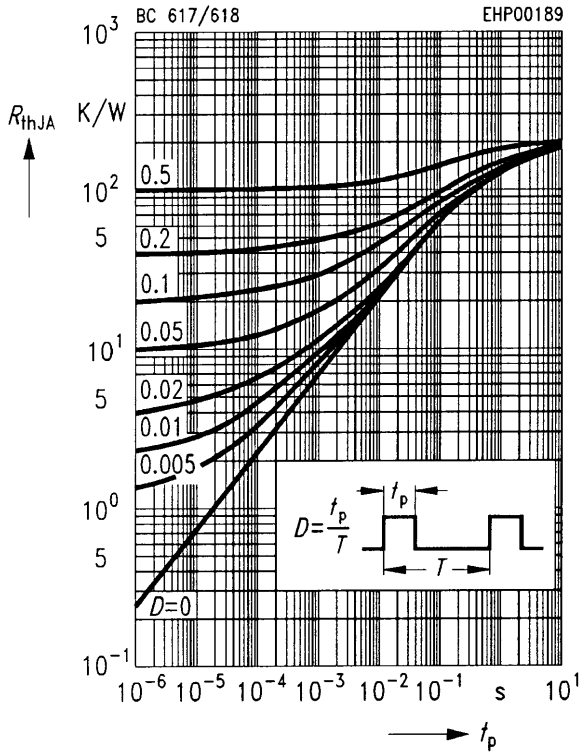

**Transition frequency  $f_T = f(I_C)$**

$V_{CE} = 5\text{ V}, f = 20\text{ MHz}$

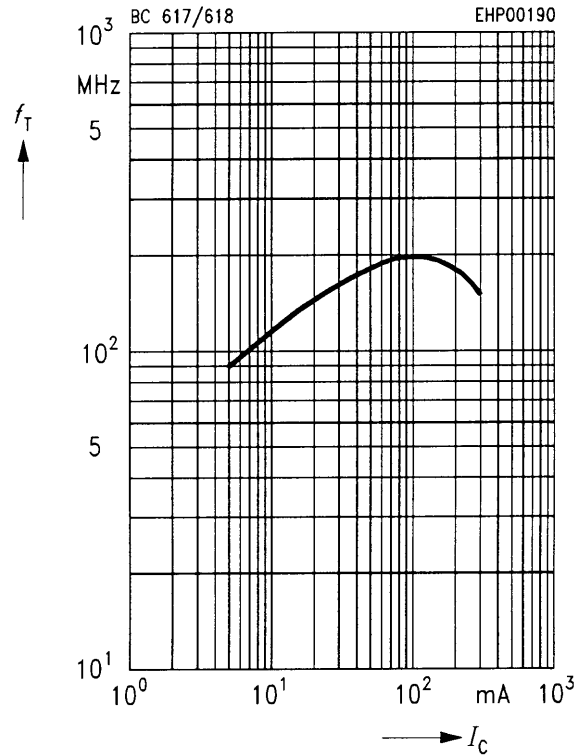

**Collector-emitter saturation voltage**

$V_{CEsat} = f(I_C)$

$h_{FE} = 1000$ , parameter =  $T_A$

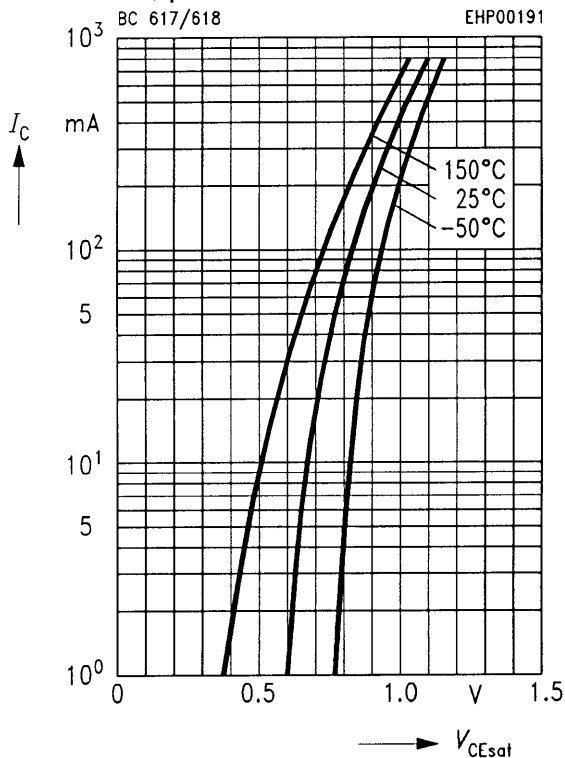

**Base-emitter saturation voltage**

$V_{BEsat} = f(I_C)$

$h_{FE} = 1000$ , parameter =  $T_A$

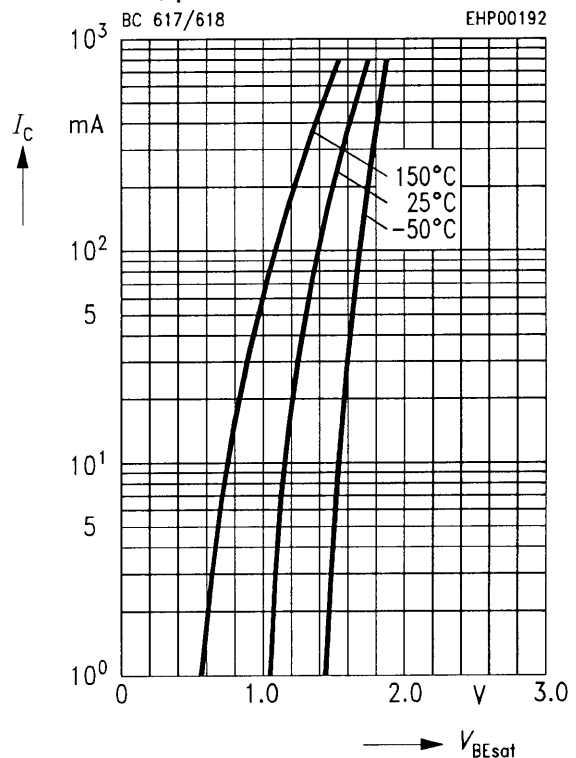

**DC current gain  $h_{FE} = f(I_C)$**

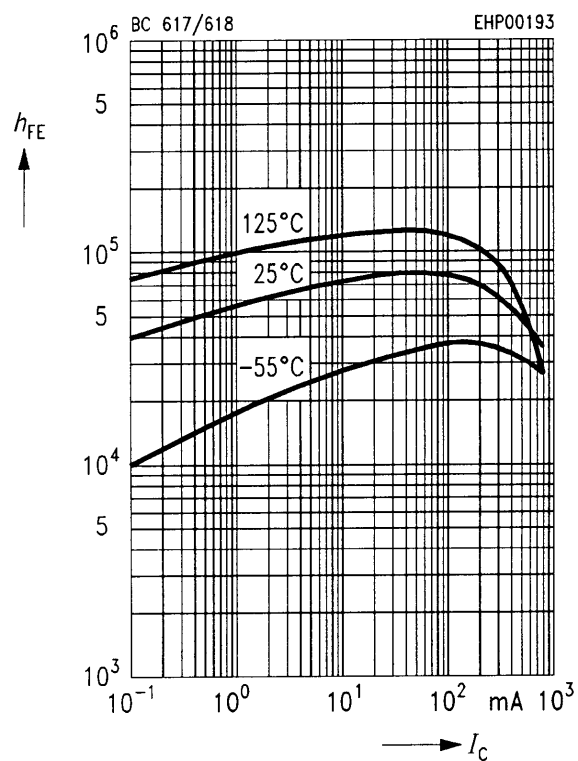

**Capacitance  $C = f(V_{EB}, V_{CB})$**

