

**SIPMOS® Power Transistor**

- N channel
- Enhancement mode
- Avalanche-rated

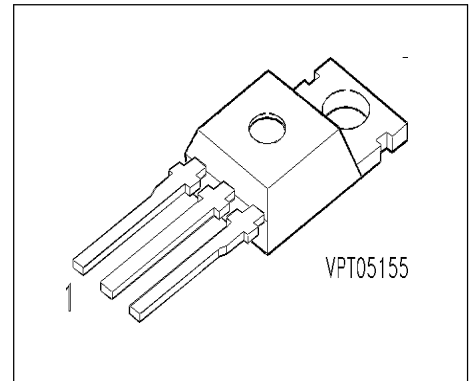

Pin 1	Pin 2	Pin 3
G	D	S

Type	V <sub>DS</sub>	I <sub>D</sub>	R <sub>DS(on)</sub>	Package	Ordering Code
BUZ 42	500 V	4 A	2 Ω	TO-220 AB	C67078-S1311-A2

**Maximum Ratings**

Parameter	Symbol	Values	Unit
Continuous drain current <i>T<sub>C</sub></i> = 30 °C	I <sub>D</sub>	4	A
Pulsed drain current <i>T<sub>C</sub></i> = 25 °C	I <sub>Dpuls</sub>	16	
Avalanche current, limited by <i>T<sub>jmax</sub></i>	I <sub>AR</sub>	4	
Avalanche energy, periodic limited by <i>T<sub>jmax</sub></i>	E <sub>AR</sub>	6	mJ
Avalanche energy, single pulse I <sub>D</sub> = 4 A, V <sub>DD</sub> = 50 V, R <sub>GS</sub> = 25 Ω L = 24.8 mH, <i>T<sub>j</sub></i> = 25 °C	E <sub>AS</sub>	220	
Gate source voltage	V <sub>GS</sub>	± 20	V
Power dissipation <i>T<sub>C</sub></i> = 25 °C	P <sub>tot</sub>	75	W
Operating temperature	<i>T<sub>j</sub></i>	-55 ... + 150	°C
Storage temperature	<i>T<sub>stg</sub></i>	-55 ... + 150	
Thermal resistance, chip case	R <sub>thJC</sub>	≤ 1.67	K/W
Thermal resistance, chip to ambient	R <sub>thJA</sub>	75	
DIN humidity category, DIN 40 040		E	
IEC climatic category, DIN IEC 68-1		55 / 150 / 56	

Electrical Characteristics, at  $T_j = 25^\circ\text{C}$ , unless otherwise specified

Parameter	Symbol	Values			Unit
		min.	typ.	max.	
<b>Static Characteristics</b>					
Drain- source breakdown voltage $V_{GS} = 0\text{ V}, I_D = 0.25\text{ mA}, T_j = 25\text{ }^\circ\text{C}$	$V_{(BR)DSS}$	500	-	-	V
Gate threshold voltage $V_{GS}=V_{DS}, I_D = 1\text{ mA}$	$V_{GS(th)}$	2.1	3	4	
Zero gate voltage drain current $V_{DS} = 500\text{ V}, V_{GS} = 0\text{ V}, T_j = 25\text{ }^\circ\text{C}$ $V_{DS} = 500\text{ V}, V_{GS} = 0\text{ V}, T_j = 125\text{ }^\circ\text{C}$	$I_{DSS}$	-	0.1 10	1 100	$\mu\text{A}$
Gate-source leakage current $V_{GS} = 20\text{ V}, V_{DS} = 0\text{ V}$	$I_{GSS}$	-	10	100	nA
Drain-Source on-resistance $V_{GS} = 10\text{ V}, I_D = 2.6\text{ A}$	$R_{DS(on)}$	-	1.6	2	$\Omega$

Electrical Characteristics, at  $T_j = 25^\circ\text{C}$ , unless otherwise specified

Parameter	Symbol	Values			Unit
		min.	typ.	max.	
<b>Dynamic Characteristics</b>					
Transconductance $V_{DS} \geq 2 * I_D * R_{DS(on)max}, I_D = 2.6 \text{ A}$	$g_{fs}$	1.5	2.8	-	S
Input capacitance $V_{GS} = 0 \text{ V}, V_{DS} = 25 \text{ V}, f = 1 \text{ MHz}$	$C_{iss}$	-	600	900	pF
Output capacitance $V_{GS} = 0 \text{ V}, V_{DS} = 25 \text{ V}, f = 1 \text{ MHz}$	$C_{oss}$	-	65	100	
Reverse transfer capacitance $V_{GS} = 0 \text{ V}, V_{DS} = 25 \text{ V}, f = 1 \text{ MHz}$	$C_{rss}$	-	25	40	
Turn-on delay time $V_{DD} = 30 \text{ V}, V_{GS} = 10 \text{ V}, I_D = 2.5 \text{ A}$ $R_{GS} = 50 \Omega$	$t_{d(on)}$	-	10	15	ns
Rise time $V_{DD} = 30 \text{ V}, V_{GS} = 10 \text{ V}, I_D = 2.5 \text{ A}$ $R_{GS} = 50 \Omega$	$t_r$	-	50	70	
Turn-off delay time $V_{DD} = 30 \text{ V}, V_{GS} = 10 \text{ V}, I_D = 2.5 \text{ A}$ $R_{GS} = 50 \Omega$	$t_{d(off)}$	-	70	95	
Fall time $V_{DD} = 30 \text{ V}, V_{GS} = 10 \text{ V}, I_D = 2.5 \text{ A}$ $R_{GS} = 50 \Omega$	$t_f$	-	40	55	

**Electrical Characteristics, at  $T_j = 25^\circ\text{C}$ , unless otherwise specified**

Parameter	Symbol	Values			Unit
		min.	typ.	max.	
<b>Reverse Diode</b>					
Inverse diode continuous forward current $T_C = 25^\circ\text{C}$	$I_S$	-	-	4	A
Inverse diode direct current,pulsed $T_C = 25^\circ\text{C}$	$I_{SM}$	-	-	16	
Inverse diode forward voltage $V_{GS} = 0\text{ V}, I_F = 8\text{ A}$	$V_{SD}$	-	1	1.4	V
Reverse recovery time $V_R = 100\text{ V}, I_F = I_S, di_F/dt = 100\text{ A}/\mu\text{s}$	$t_{rr}$	-	300	-	ns
Reverse recovery charge $V_R = 100\text{ V}, I_F = I_S, di_F/dt = 100\text{ A}/\mu\text{s}$	$Q_{rr}$	-	2.5	-	$\mu\text{C}$

### Power dissipation

$$P_{\text{tot}} = f(T_C)$$

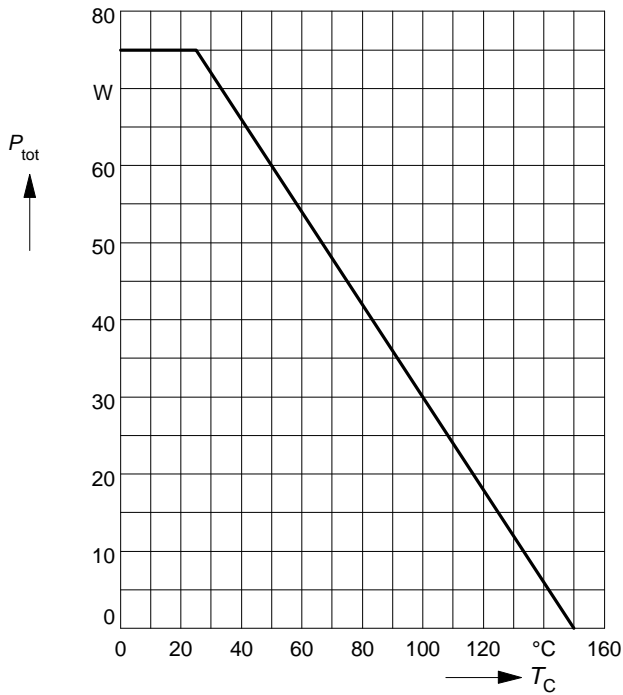

### Drain current

$$I_D = f(T_C)$$

parameter:  $V_{GS} \geq 10 \text{ V}$

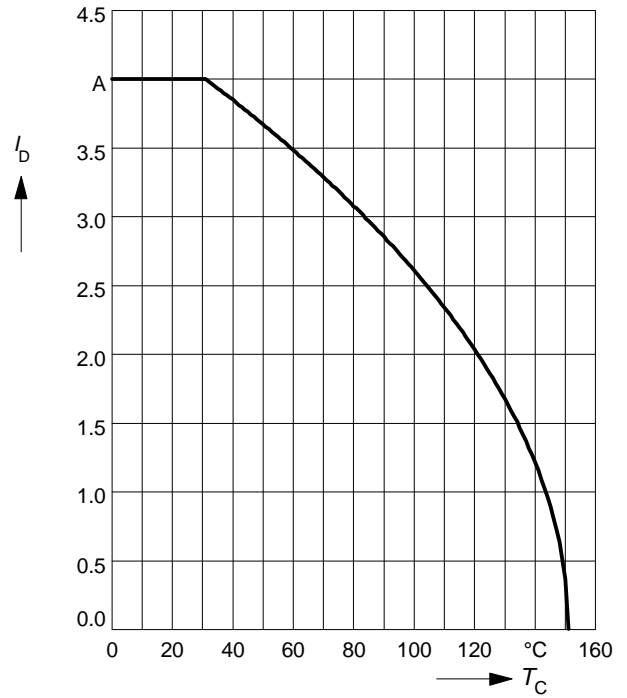

### Safe operating area

$$I_D = f(V_{DS})$$

parameter:  $D = 0.01, T_C = 25^\circ\text{C}$

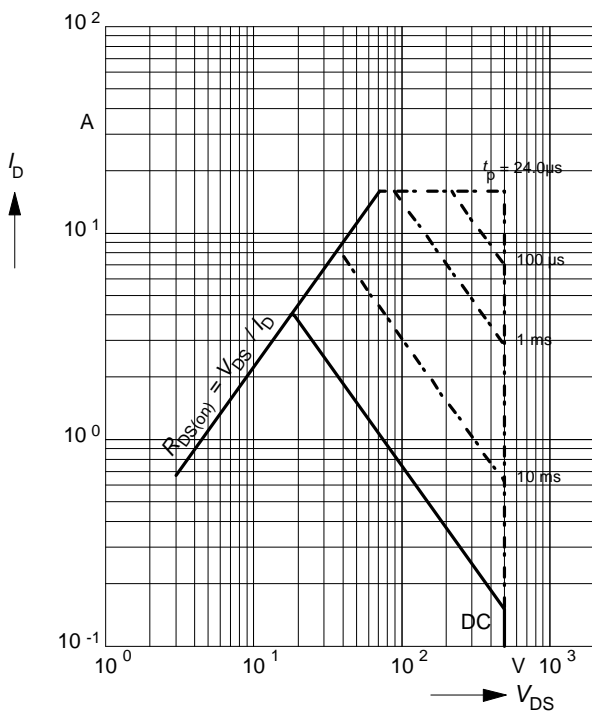

### Transient thermal impedance

$$Z_{\text{th JC}} = f(t_p)$$

parameter:  $D = t_p / T$

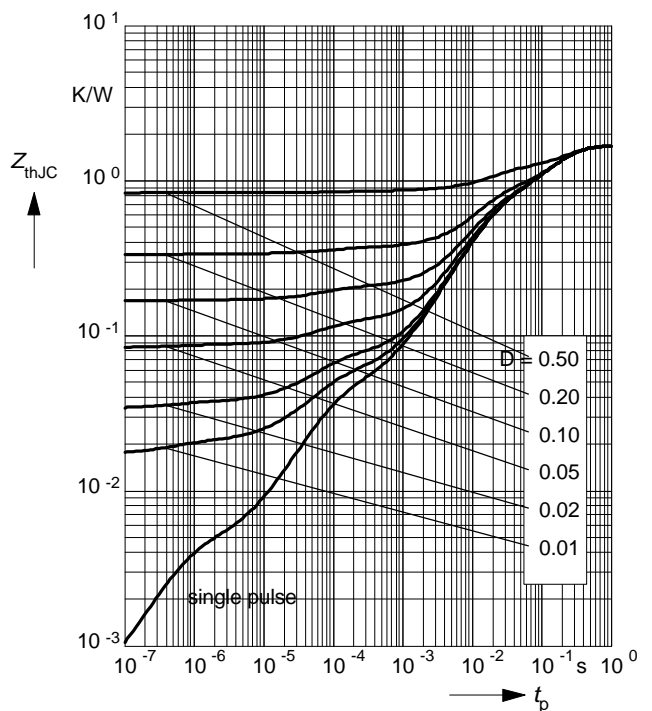

### Typ. output characteristics

$$I_D = f(V_{DS})$$

parameter:  $t_p = 80 \mu s$

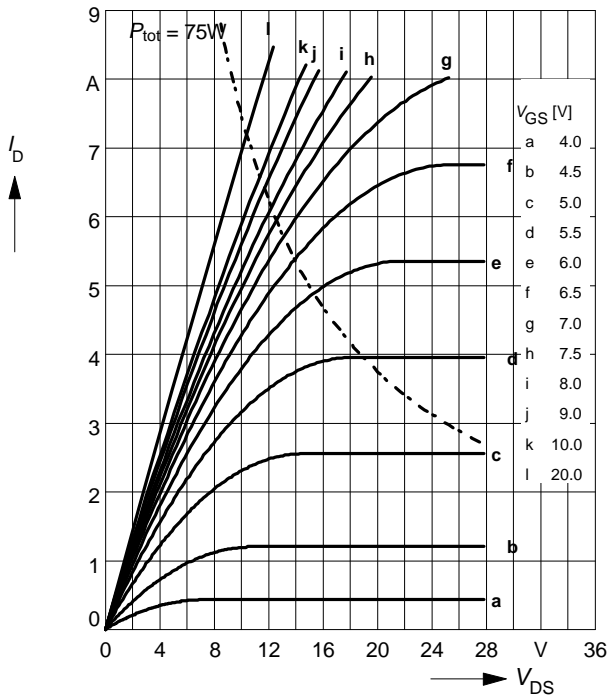

### Typ. drain-source on-resistance

$$R_{DS(on)} = f(I_D)$$

parameter:  $V_{GS}$

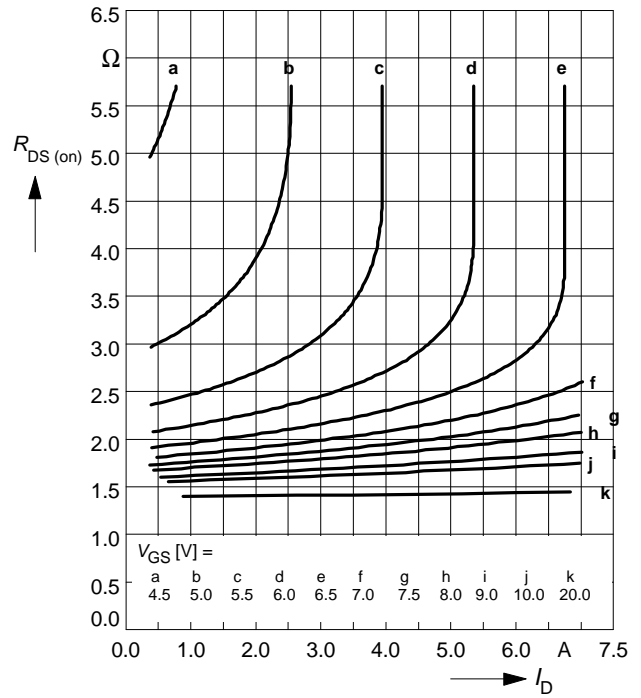

### Typ. transfer characteristics $I_D = f(V_{GS})$

parameter:  $t_p = 80 \mu s$

$$V_{DS} \geq 2 \times I_D \times R_{DS(on)max}$$

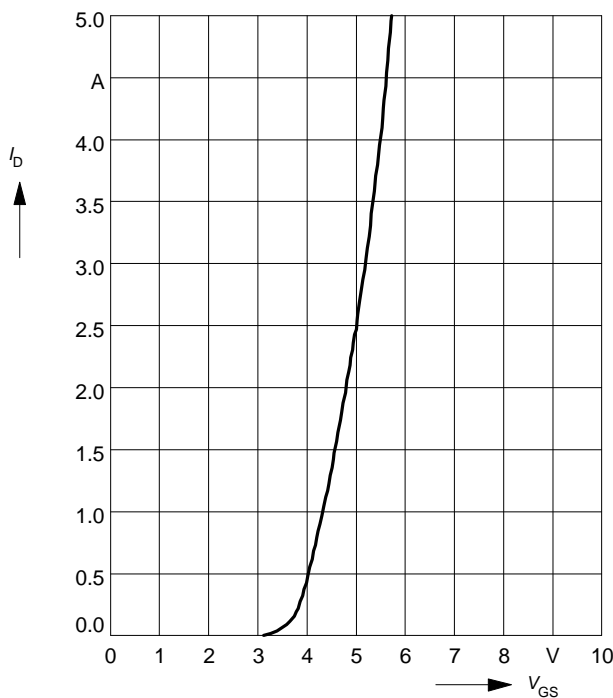

### Typ. forward transconductance $g_{fs} = f(I_D)$

parameter:  $t_p = 80 \mu s$ ,

$$V_{DS} \geq 2 \times I_D \times R_{DS(on)max}$$

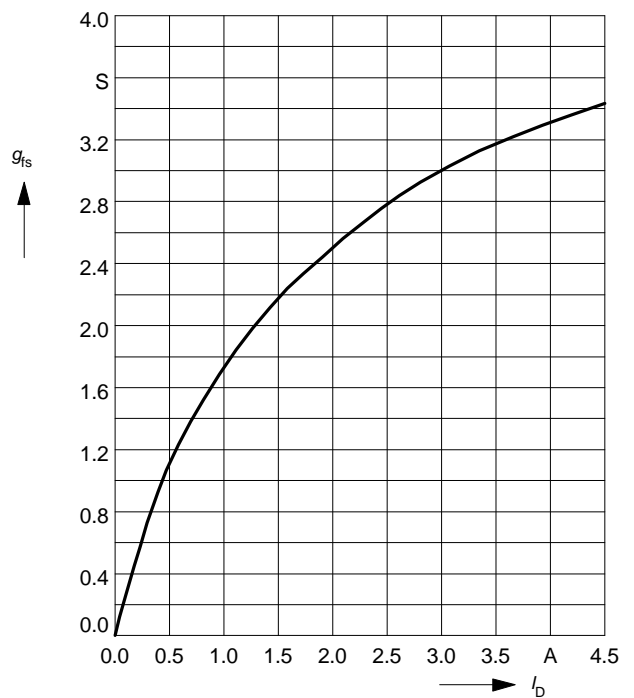

### Drain-source on-resistance

$$R_{DS(on)} = f(T_j)$$

parameter:  $I_D = 2.6 \text{ A}$ ,  $V_{GS} = 10 \text{ V}$

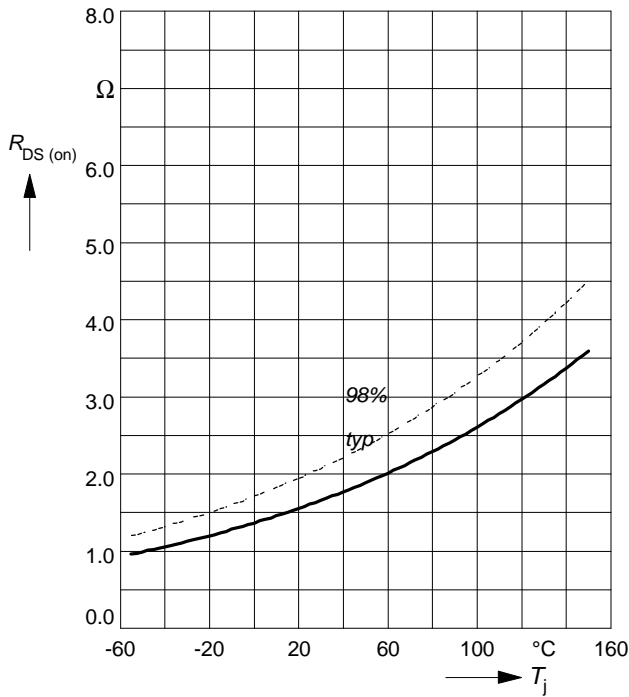

### Gate threshold voltage

$$V_{GS(th)} = f(T_j)$$

parameter:  $V_{GS} = V_{DS}$ ,  $I_D = 1 \text{ mA}$

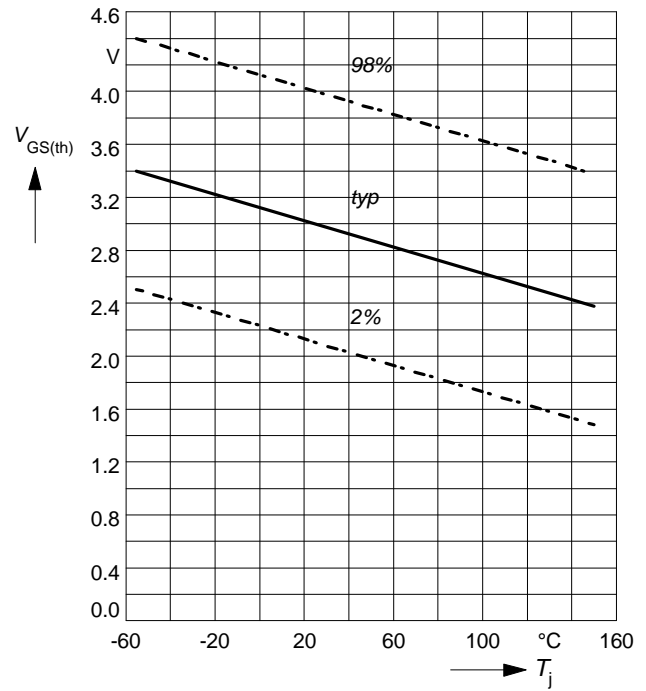

### Typ. capacitances

$$C = f(V_{DS})$$

parameter:  $V_{GS} = 0 \text{ V}$ ,  $f = 1 \text{ MHz}$

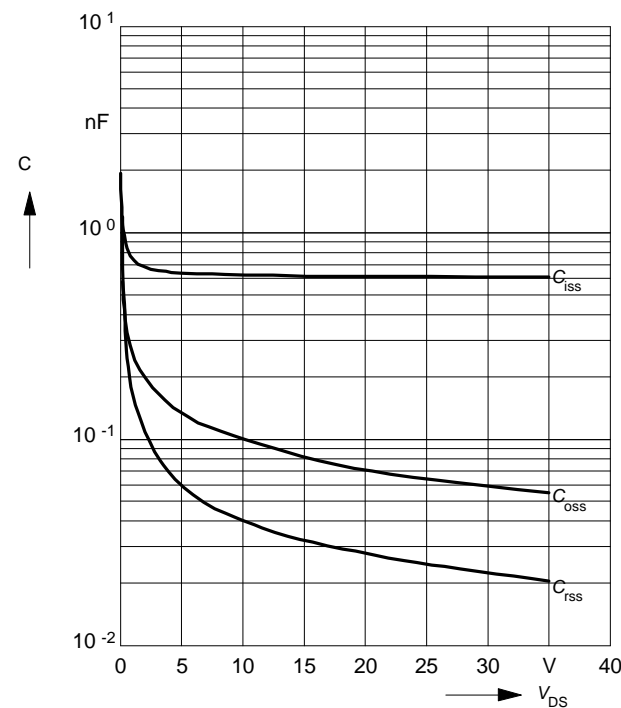

### Forward characteristics of reverse diode

$$I_F = f(V_{SD})$$

parameter:  $T_j$ ,  $t_p = 80 \mu\text{s}$

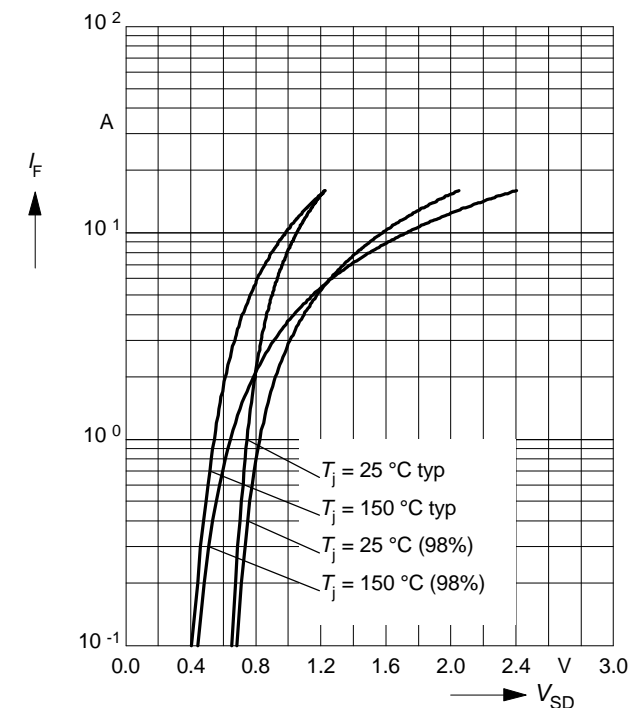

**Avalanche energy**  $E_{AS} = f(T_j)$   
 parameter:  $I_D = 4\text{ A}$ ,  $V_{DD} = 50\text{ V}$   
 $R_{GS} = 25\ \Omega$ ,  $L = 24.8\text{ mH}$

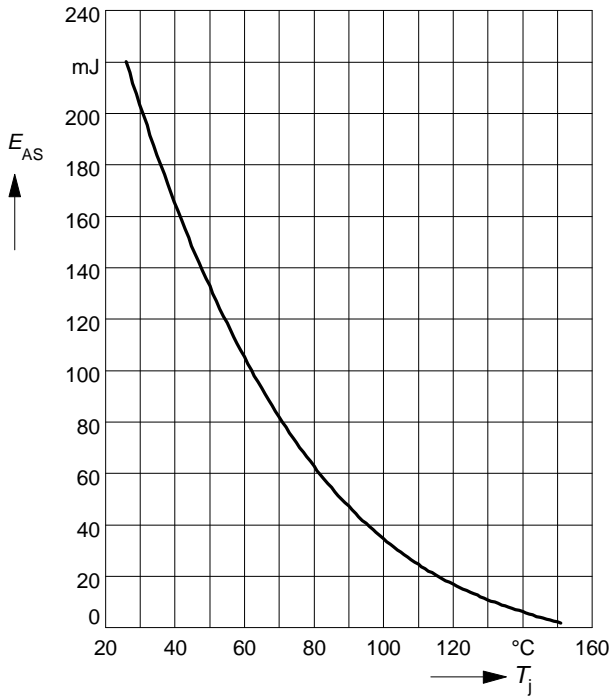

**Typ. gate charge**  
 $V_{GS} = f(Q_{Gate})$   
 parameter:  $I_{D\text{ puls}} = 6\text{ A}$

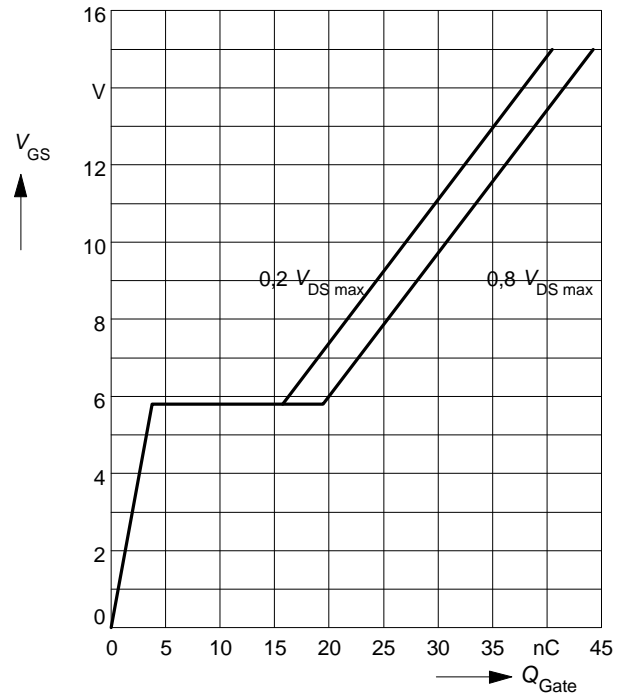

**Drain-source breakdown voltage**

$V_{(BR)DSS} = f(T_j)$

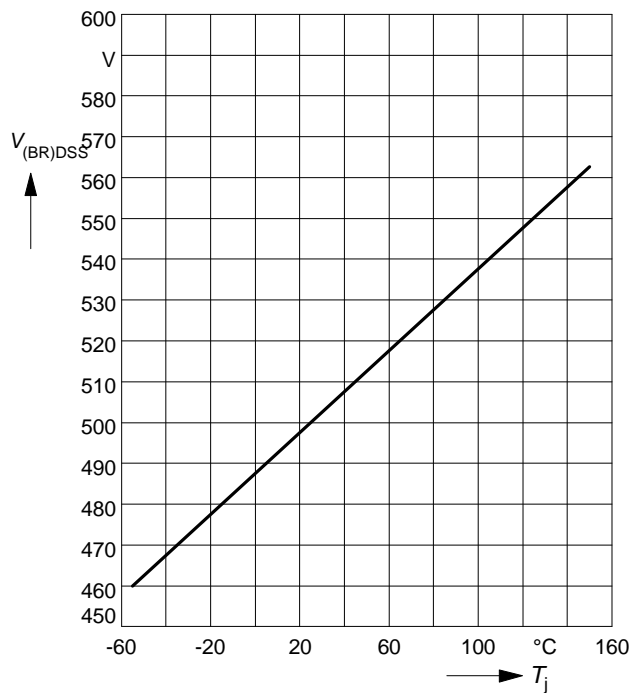



### Package Outlines

TO-220 AB

Dimension in mm

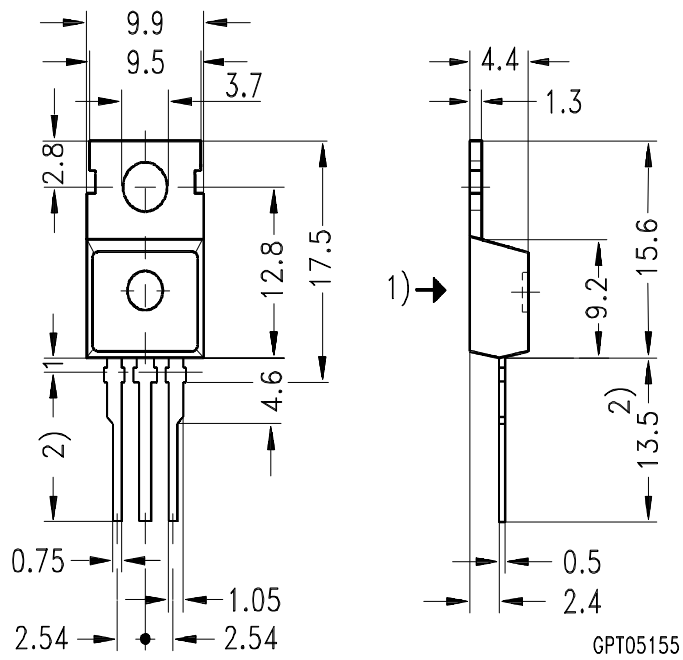

- 1) punch direction, burr max. 0.04
- 2) dip tinning
- 3) max. 14.5 by dip tinning press burr max. 0.05