

TOSHIBA BIPOLAR DIGITAL INTEGRATED CIRCUIT SILICON MONOLITHIC

TD62503FB, TD62504FB

7CH SINGLE DRIVER : COMMON EMITTER

The TD62503FB and TD62504FB are comprised of seven or five NPN transistor arrays.

Applications include relay, hammer, lamp and display (LED) drivers.

FEATURES

- Output current (single output) 200mA / ch (Max.)
- High sustaining voltage output 35V (Min.)
- Low saturation voltage $V_{CE(sat)} = 0.8V @ I_{OUT} = 150mA$
- Inputs compatible with various types of logic.
- TD62503FB : $R_{IN} = 2.7k\Omega$ TTL, 5V CMOS
- TD62504FB : $R_{IN} = 10.5k\Omega$... 6~15V PMOS, CMOS
- Package type-FB : SOP-16 pin

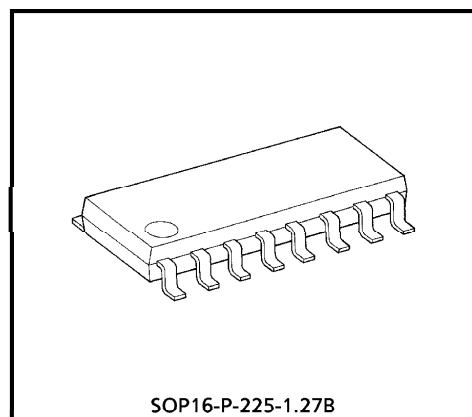

Weight : 0.16g (Typ.)

PIN CONNECTION (TOP VIEW)

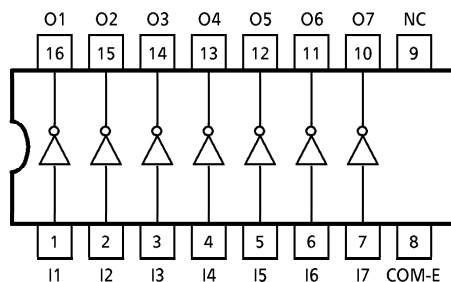

SCHEMATICS (EACH DRIVER)

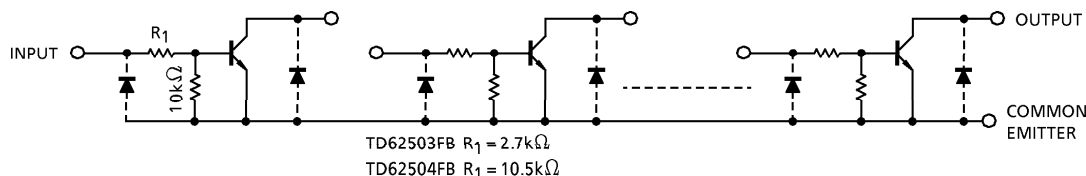

(Note) The input and output parasitic diodes cannot be used as clamp diodes.

961001EBA2

● TOSHIBA is continually working to improve the quality and the reliability of its products. Nevertheless, semiconductor devices in general can malfunction or fail due to their inherent electrical sensitivity and vulnerability to physical stress. It is the responsibility of the buyer, when utilizing TOSHIBA products, to observe standards of safety, and to avoid situations in which a malfunction or failure of a TOSHIBA product could cause loss of human life, bodily injury or damage to property. In developing your designs, please ensure that TOSHIBA products are used within specified operating ranges as set forth in the most recent products specifications. Also, please keep in mind the precautions and conditions set forth in the TOSHIBA Semiconductor Reliability Handbook.

MAXIMUM RATINGS (Ta = 25°C)

CHARACTERISTIC	SYMBOL	RATING	UNIT
Collector-Emitter Voltage	V _{CEO}	35	V
Collector-Base Voltage	V _{CB0}	50	V
Collector Current	I _C	200	mA / ch
Input Voltage	V _{IN}	- 0.5~30	V
Power Dissipation	P _D (Note)	0.625	W
Operating Temperature	T _{opr}	- 40~85	°C
Storage Temperature	T _{stg}	- 55~150	°C

(Note) On PCB (30 × 30 × 1.6mm Cu 50%)
 Delated above 25°C in the proportion of 5.0mW / °C.

RECOMMENDED OPERATING CONDITIONS (Ta = - 40~85°C)

CHARACTERISTIC	SYMBOL	TEST CONDITION	MIN.	TYP.	MAX.	UNIT
Collector-Emitter Voltage	V _{CEO}	—	0	—	35	V
Collector-Base Voltage	V _{CB0}	—	0	—	50	V
Collector Current	I _C	—	0	—	150	mA / ch
Input Voltage	V _{IN}	—	0	—	25	V
Power Dissipation	P _D	(Note)	—	—	0.325	W

(Note) On PCB (30 × 30 × 1.6mm Cu 50%)

ELECTRICAL CHARACTERISTICS (Ta = 25°C)

CHARACTERISTIC	SYMBOL	TEST CIR-CUIT	TEST CONDITION	MIN.	TYP.	MAX.	UNIT
Output Leakage Current	I _{CEX}	1	V _{CE} = 25V, V _{IN} = 0V	—	—	10	μA
Collector-Emitter Saturation Voltage	V _{CE (sat)}	2	I _{IN} = 1mA, I _C = 10mA	—	—	0.2	V
			I _{IN} = 3mA, I _C = 150mA	—	—	0.8	
DC Current Transfer Ratio	h _{FE}	2	V _{CE} = 10V, I _C = 10mA	50	—	—	—
Input Voltage (Output On)	V _{IN (ON)}	3	I _{IN} = 1mA, I _C = 10mA	2.4	3.4	4.2	V
				7.5	11.5	15	
Input Voltage (Output Off)	V _{IN (OFF)}	—	—	0.6	0.8	1.0	V
				1.1	1.6	1.9	
Turn-On Delay	t _{ON}	4	V _{OUT} = 35V, R _L = 220Ω C _L = 15pF	—	50	—	ns
Turn-Off Delay	t _{OFF}			—	200	—	

961001EBA2'

- The products described in this document are subject to foreign exchange and foreign trade control laws.
- The information contained herein is presented only as a guide for the applications of our products. No responsibility is assumed by TOSHIBA CORPORATION for any infringements of intellectual property or other rights of the third parties which may result from its use. No license is granted by implication or otherwise under any intellectual property or other rights of TOSHIBA CORPORATION or others.
- The information contained herein is subject to change without notice.

TEST CIRCUIT

1. I_{CEX}

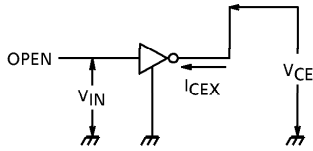

2. h_{FE} , $V_{CE(sat)}$

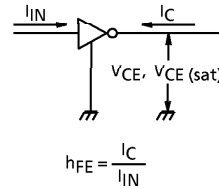

3. $V_{IN(ON)}$

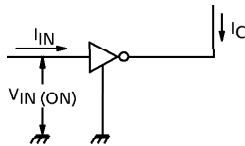

4. t_{ON} , t_{OFF}

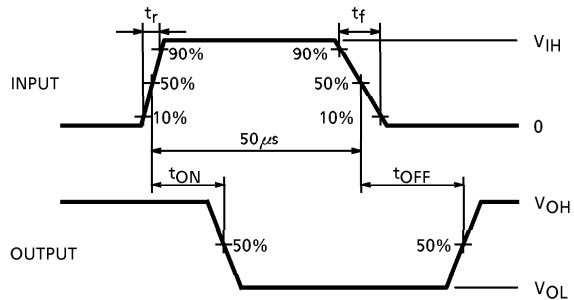
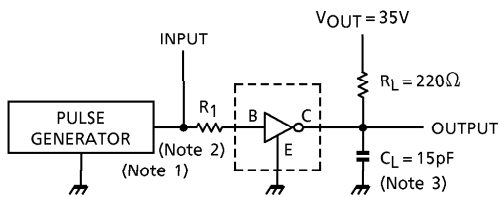

- (Note 1) Pulse Width $50\mu s$, Duty Cycle 10%
Output Impedance 50Ω , $t_r \leq 5ns$, $t_f \leq 10ns$
- (Note 2) See below.

INPUT CONDITION

TYPE NUMBER	R_{IN}	V_{IH}
TD62503FB	0Ω	3V
TD62504FB	0Ω	10V

- (Note 3) C_L includes probe and jig capacitance.

PRECAUTIONS for USING

Utmost care is necessary in the design of the output line, V_{CC} and GND line since IC may be destroyed due to short-circuit between outputs, air contamination fault, or fault by improper grounding.

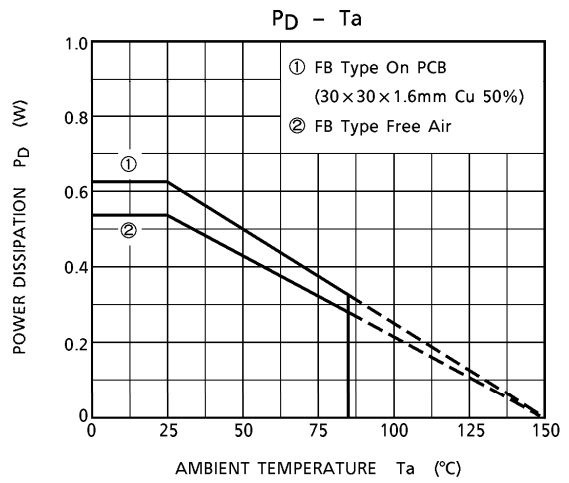
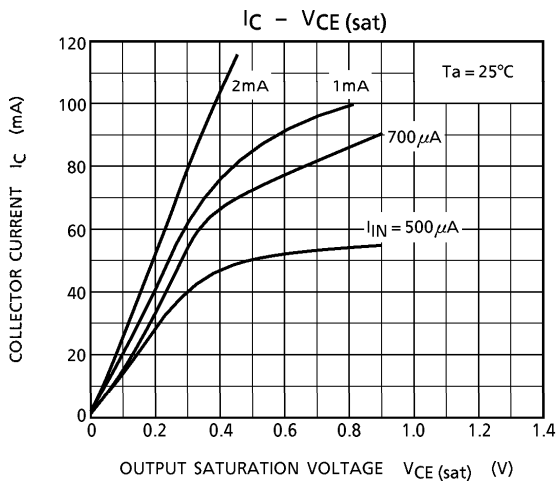
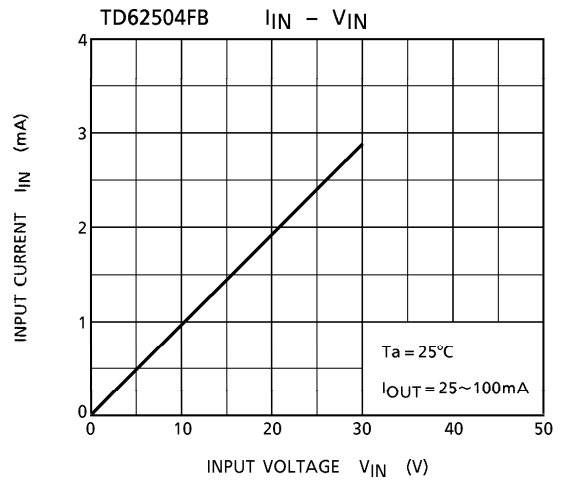
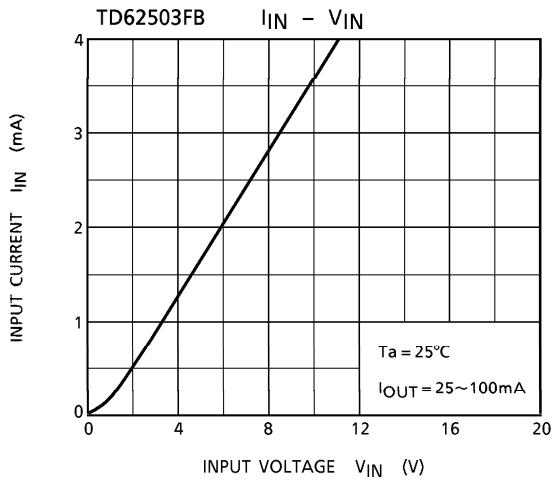

OUTLINE DRAWING
SOP16-P-225-1.27B

Unit : mm

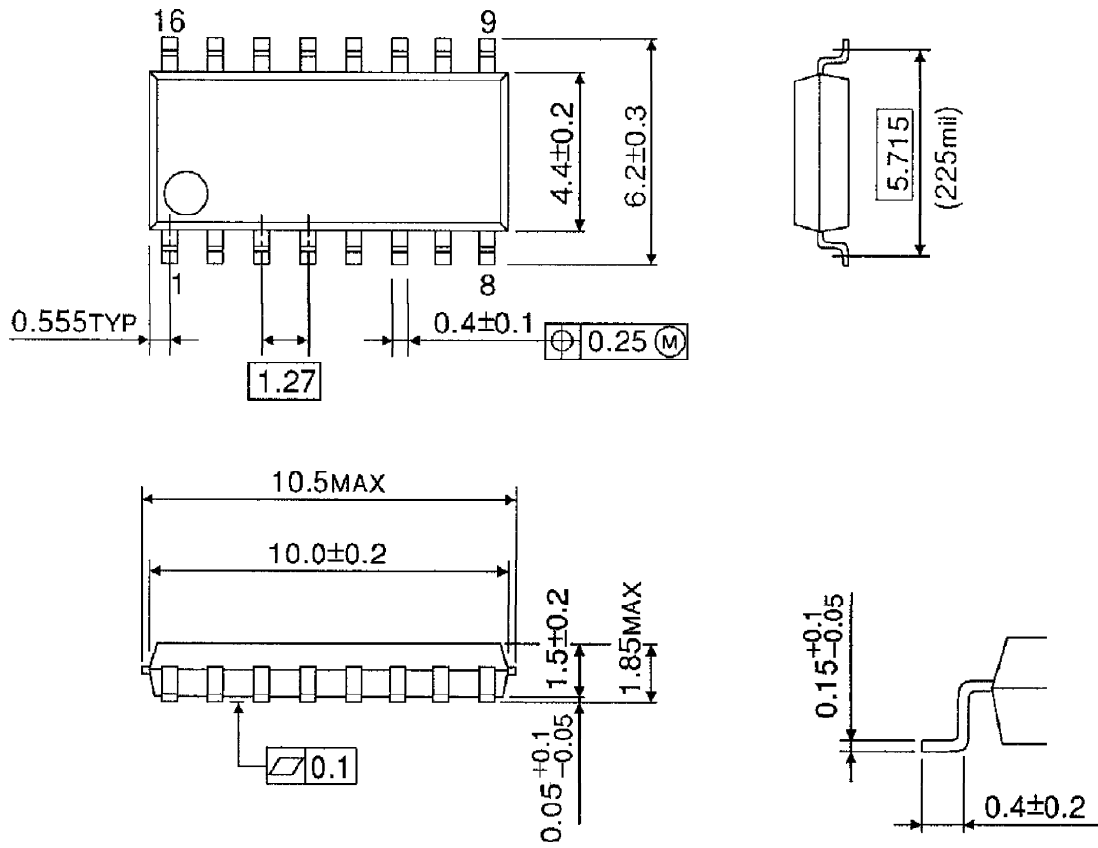

Weight : 0.16g (Typ.)