

SWITCHMODE™

NPN Bipolar Power Transistor

For Switching Power Supply Applications

The MJE/MJF18004 have an applications specific state-of-the-art die designed for use in 220 V line operated Switchmode Power supplies and electronic light ballasts. This high voltage/high speed transistors offer the following:

- Improved Efficiency Due to Low Base Drive Requirements:
 - High and Flat DC Current Gain h_{FE}
 - Fast Switching
 - No Coil Required in Base Circuit for Turn-Off (No Current Tail)
- Full Characterization at 125°C
- ON Semiconductor Six Sigma Philosophy Provides Tight and Reproducible Parametric Distributions
- Two Package Choices: Standard TO-220 or Isolated TO-220
- MJF18004, Case 221D, is UL Recognized at 3500 VRMS: File #E69369

MAXIMUM RATINGS

Rating	Symbol	MJE18004	MJF18004	Unit
Collector-Emitter Sustaining Voltage	V_{CEO}	450		Vdc
Collector-Emitter Breakdown Voltage	V_{CES}	1000		Vdc
Emitter-Base Voltage	V_{EBO}	9.0		Vdc
Collector Current — Continuous	I_C	5.0		Adc
— Peak(1)	I_{CM}	10		
Base Current — Continuous	I_B	2.0		Adc
— Peak(1)	I_{BM}	4.0		
RMS Isolation Voltage(2) Test No. 1 Per Fig. 22a	V_{ISOL}	—	4500	Volts
(for 1 sec, R.H. Test No. 2 Per Fig. 22b		—	3500	
< 30%, $T_A = 25^\circ C$) Test No. 3 Per Fig. 22c		—	1500	
Total Device Dissipation ($T_C = 25^\circ C$)	P_D	75	35	Watts
Derate above 25°C		0.6	0.28	W/°C
Operating and Storage Temperature	T_J, T_{stg}	-65 to 150		°C

THERMAL CHARACTERISTICS

Rating	Symbol	MJE18004	MJF18004	Unit
Thermal Resistance — Junction to Case	$R_{\theta JC}$	1.65	3.55	°C/W
— Junction to Ambient	$R_{\theta JA}$	62.5	62.5	
Maximum Lead Temperature for Soldering Purposes: 1/8" from Case for 5 Seconds	T_L	260		°C

MJE18004*
MJF18004*

*ON Semiconductor Preferred Device

POWER TRANSISTOR
5.0 AMPERES
1000 VOLTS
35 and 75 WATTS

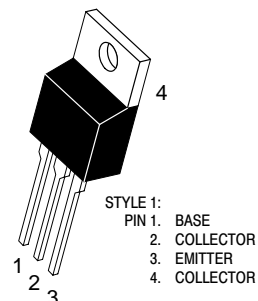

CASE 221A-09
TO-220AB
MJE18004

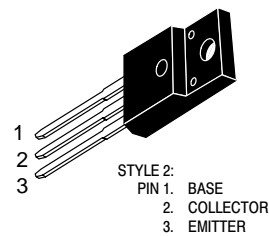

CASE 221D-02
ISOLATED TO-220 TYPE
MJF18004

Preferred devices are ON Semiconductor recommended choices for future use and best overall value.

MJE18004 MJF18004

ELECTRICAL CHARACTERISTICS ($T_C = 25^\circ\text{C}$ unless otherwise specified)

Characteristic	Symbol	Min	Typ	Max	Unit	
OFF CHARACTERISTICS						
Collector–Emitter Sustaining Voltage ($I_C = 100\text{ mA}$, $L = 25\text{ mH}$)	$V_{CEO(sus)}$	450	—	—	Vdc	
Collector Cutoff Current ($V_{CE} = \text{Rated } V_{CEO}$, $I_B = 0$)	I_{CEO}	—	—	100	μAdc	
Collector Cutoff Current ($V_{CE} = \text{Rated } V_{CES}$, $V_{EB} = 0$) ($V_{CE} = 800\text{ V}$, $V_{EB} = 0$)	I_{CES}	($T_C = 25^\circ\text{C}$)	—	—	100	μAdc
		($T_C = 125^\circ\text{C}$)	—	—	500	
		($T_C = 125^\circ\text{C}$)	—	—	100	
Emitter Cutoff Current ($V_{EB} = 9.0\text{ Vdc}$, $I_C = 0$)	I_{EBO}	—	—	100	μAdc	

ON CHARACTERISTICS

Base–Emitter Saturation Voltage ($I_C = 1.0\text{ Adc}$, $I_B = 0.1\text{ Adc}$) ($I_C = 2.0\text{ Adc}$, $I_B = 0.4\text{ Adc}$)	$V_{BE(sat)}$	—	0.82	1.1	Vdc	
		—	0.92	1.25		
Collector–Emitter Saturation Voltage ($I_C = 1.0\text{ Adc}$, $I_B = 0.1\text{ Adc}$) ($I_C = 2.0\text{ Adc}$, $I_B = 0.4\text{ Adc}$) ($I_C = 2.5\text{ Adc}$, $I_B = 0.5\text{ Adc}$)	$V_{CE(sat)}$	—	0.25	0.5	Vdc	
		($T_C = 125^\circ\text{C}$)	—	0.29		0.6
		($T_C = 125^\circ\text{C}$)	—	0.3		0.45
		($T_C = 125^\circ\text{C}$)	—	0.36		0.8
DC Current Gain ($I_C = 1.0\text{ Adc}$, $V_{CE} = 2.5\text{ Vdc}$) ($I_C = 0.3\text{ Adc}$, $V_{CE} = 5.0\text{ Vdc}$) ($I_C = 2.0\text{ Adc}$, $V_{CE} = 1.0\text{ Vdc}$) ($I_C = 10\text{ mAdc}$, $V_{CE} = 5.0\text{ Vdc}$)	h_{FE}	12	21	—	—	
		($T_C = 125^\circ\text{C}$)	—	20		—
		($T_C = 125^\circ\text{C}$)	14	—		34
		($T_C = 125^\circ\text{C}$)	—	32		—
		($T_C = 125^\circ\text{C}$)	6.0	11		—
($T_C = 125^\circ\text{C}$)	—	7.5	—			
($T_C = 125^\circ\text{C}$)	10	22	—			

DYNAMIC CHARACTERISTICS

Current Gain Bandwidth ($I_C = 0.5\text{ Adc}$, $V_{CE} = 10\text{ Vdc}$, $f = 1.0\text{ MHz}$)				f_T	—	13	—	MHz
Output Capacitance ($V_{CB} = 10\text{ Vdc}$, $I_E = 0$, $f = 1.0\text{ MHz}$)				C_{ob}	—	50	65	pF
Input Capacitance ($V_{EB} = 8.0\text{ V}$)				C_{ib}	—	800	1000	pF
Dynamic Saturation Voltage: Determined 1.0 μs and 3.0 μs respectively after rising I_{B1} reaches 90% of final I_{B1} (see Figure 18)	($I_C = 1.0\text{ Adc}$ $I_{B1} = 100\text{ mAdc}$ $V_{CC} = 300\text{ V}$)	1.0 μs	($T_C = 125^\circ\text{C}$)	$V_{CE(dsat)}$	—	6.8	—	Vdc
		3.0 μs	($T_C = 125^\circ\text{C}$)		—	14	—	
	($I_C = 2.0\text{ Adc}$ $I_{B1} = 400\text{ mAdc}$ $V_{CC} = 300\text{ V}$)	1.0 μs	($T_C = 125^\circ\text{C}$)		—	11.3	—	
			($T_C = 125^\circ\text{C}$)		—	15.5	—	
		3.0 μs	($T_C = 125^\circ\text{C}$)		—	1.3	—	
			($T_C = 125^\circ\text{C}$)		—	6.1	—	

(1) Pulse Test: Pulse Width = 5.0 ms, Duty Cycle $\leq 10\%$.

(2) Proper strike and creepage distance must be provided.

(continued)

MJE18004 MJF18004

ELECTRICAL CHARACTERISTICS — continued ($T_C = 25^\circ\text{C}$ unless otherwise specified)

Characteristic	Symbol	Min	Typ	Max	Unit
----------------	--------	-----	-----	-----	------

SWITCHING CHARACTERISTICS: Resistive Load (D.C. $\leq 10\%$, Pulse Width = 20 μs)

Turn-On Time	($I_C = 1.0 \text{ Adc}$, $I_{B1} = 0.1 \text{ Adc}$, $I_{B2} = 0.5 \text{ Adc}$, $V_{CC} = 300 \text{ V}$) ($T_C = 125^\circ\text{C}$)	t_{on}	—	210 180	300 —	ns
Turn-Off Time		t_{off}	—	1.0 1.3	1.7 —	μs
Turn-On Time	($I_C = 2.0 \text{ Adc}$, $I_{B1} = 0.4 \text{ Adc}$, $I_{B1} = 1.0 \text{ Adc}$, $V_{CC} = 300 \text{ V}$) ($T_C = 125^\circ\text{C}$)	t_{on}	—	75 90	110 —	ns
Turn-Off Time		t_{off}	—	1.5 1.8	2.5 —	μs
Turn-On Time	($I_C = 2.5 \text{ Adc}$, $I_{B1} = 0.5 \text{ Adc}$, $I_{B2} = 0.5 \text{ Adc}$, $V_{CC} = 250 \text{ V}$) ($T_C = 125^\circ\text{C}$)	t_{on}	—	450 900	800 1400	ns
Storage Time		t_s	—	2.0 2.2	3.0 3.5	μs
Fall Time		t_f	—	275 500	400 800	ns

SWITCHING CHARACTERISTICS: Inductive Load ($V_{clamp} = 300 \text{ V}$, $V_{CC} = 15 \text{ V}$, $L = 200 \mu\text{H}$)

Fall Time	($I_C = 1.0 \text{ Adc}$, $I_{B1} = 0.1 \text{ Adc}$, $I_{B2} = 0.5 \text{ Adc}$) ($T_C = 125^\circ\text{C}$)	t_{fi}	—	100 100	150 —	ns
Storage Time		t_{si}	—	1.1 1.4	1.7 —	μs
Crossover Time		t_c	—	180 160	250 —	ns
Fall Time	($I_C = 2.0 \text{ Adc}$, $I_{B1} = 0.4 \text{ Adc}$, $I_{B2} = 1.0 \text{ Adc}$) ($T_C = 125^\circ\text{C}$)	t_{fi}	—	90 150	175 —	ns
Storage Time		t_{si}	—	1.7 2.2	2.5 —	μs
Crossover Time		t_c	—	180 250	300 —	ns
Fall Time	($I_C = 2.5 \text{ Adc}$, $I_{B1} = 0.5 \text{ Adc}$, $I_{B2} = 0.5 \text{ Adc}$, $V_{BE(off)} = -5.0 \text{ Vdc}$) ($T_C = 125^\circ\text{C}$)	t_{fi}	—	70 100	130 175	ns
Storage Time		t_{si}	—	0.75 1.0	1.0 1.3	μs
Crossover Time		t_c	—	250 250	350 500	ns

TYPICAL STATIC CHARACTERISTICS

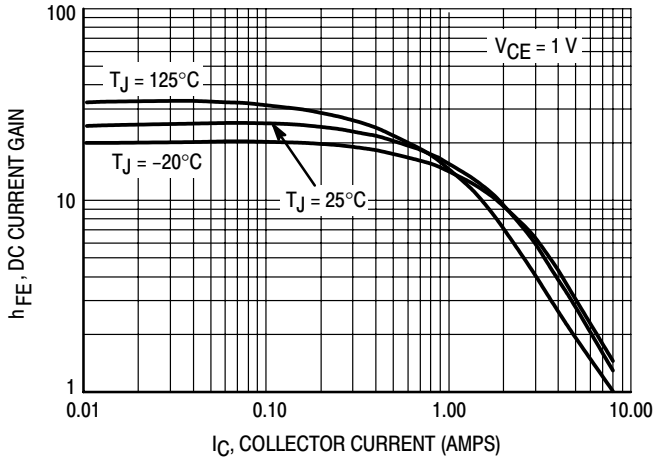

Figure 1. DC Current Gain @ 1 Volt

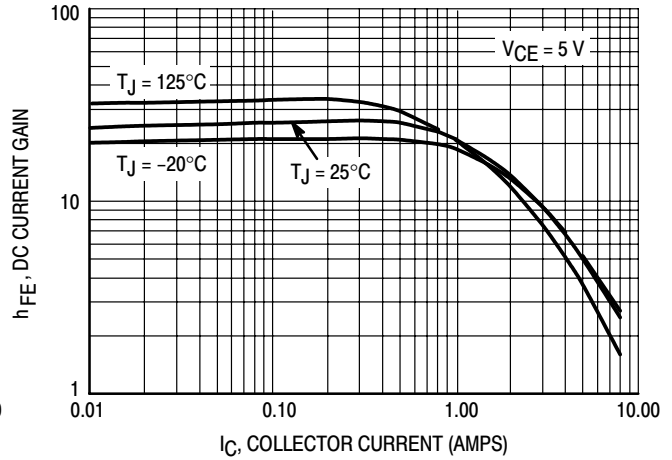

Figure 2. DC Current Gain @ 5 Volts

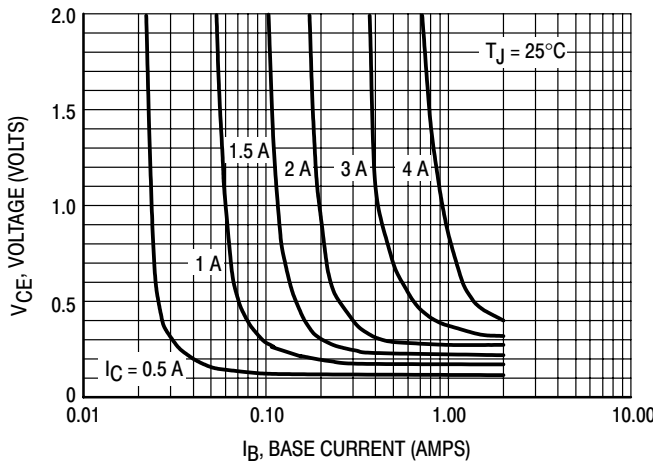

Figure 3. Collector Saturation Region

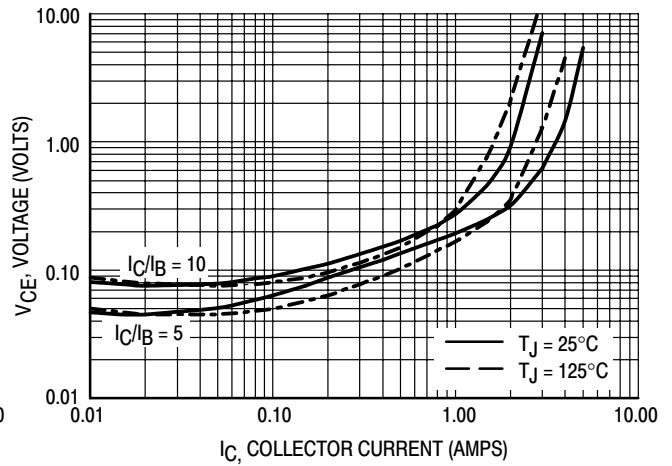

Figure 4. Collector-Emitter Saturation Voltage

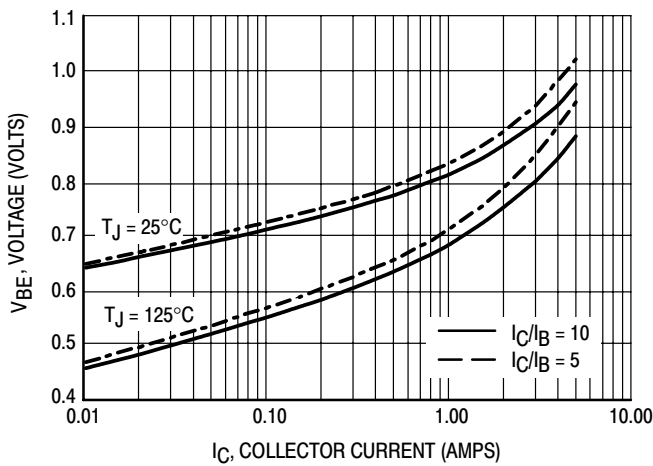

Figure 5. Base-Emitter Saturation Region

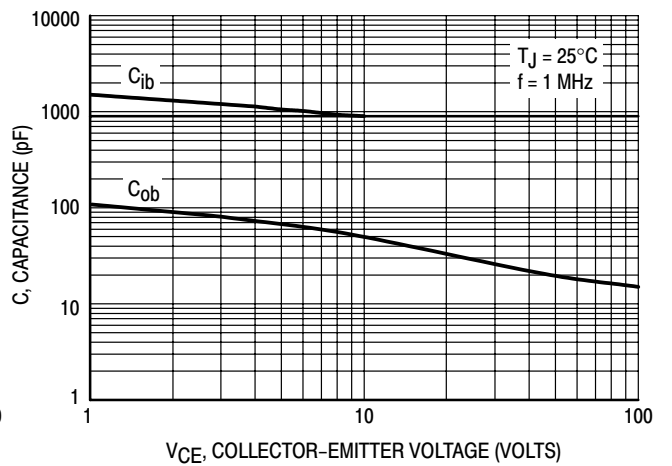

Figure 6. Capacitance

TYPICAL SWITCHING CHARACTERISTICS
($I_{B2} = I_C/2$ for all switching)

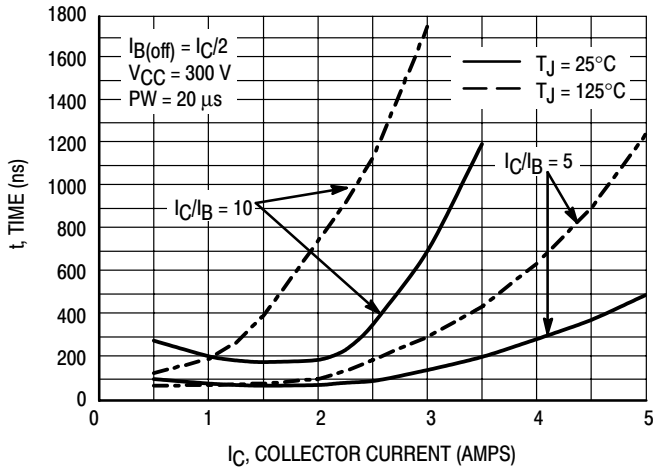

Figure 7. Resistive Switching, t_{on}

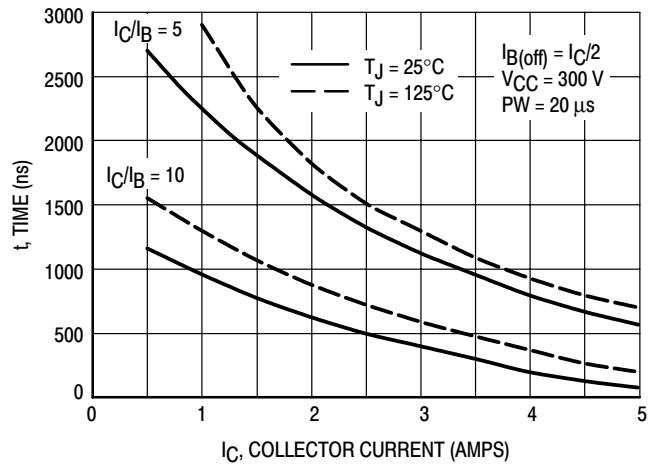

Figure 8. Resistive Switching, t_{off}

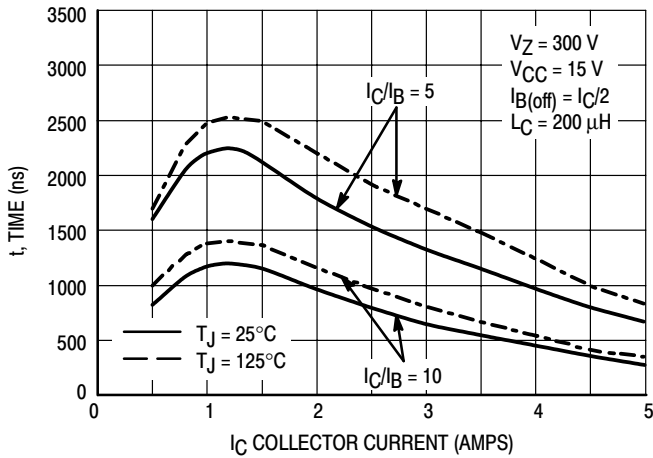

Figure 9. Inductive Storage Time, t_{sj}

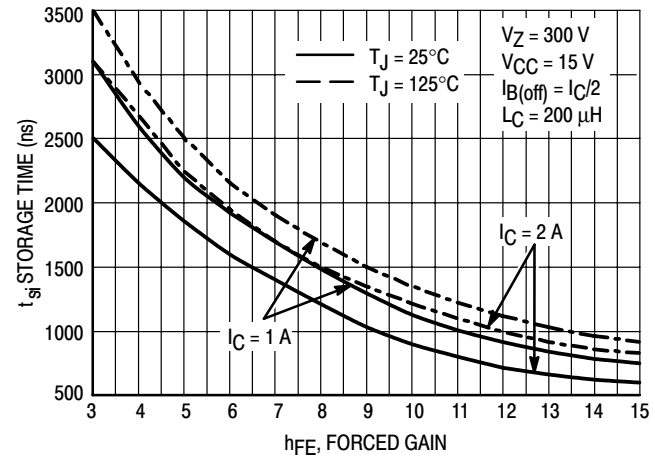

Figure 10. Inductive Storage Time, $t_{sj}(h_{FE})$

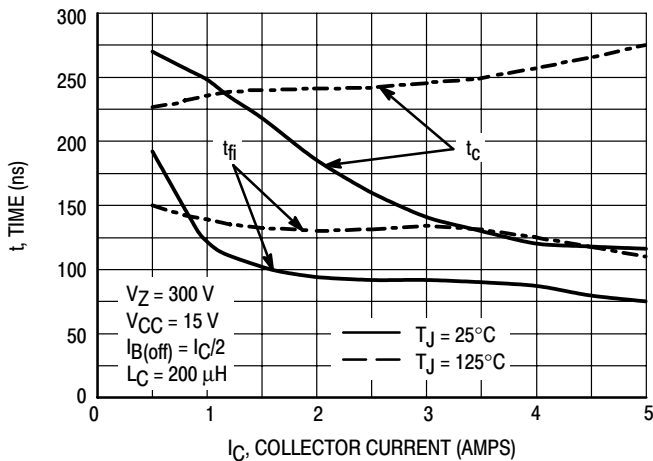

Figure 11. Inductive Switching, t_c and t_{fi} , $I_C/I_B = 5$

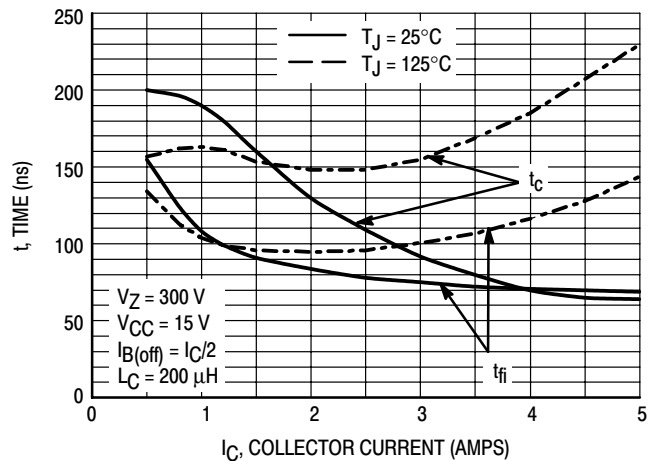

Figure 12. Inductive Switching, t_c and t_{fi} , $I_C/I_B = 10$

MJE18004 MJF18004

TYPICAL SWITCHING CHARACTERISTICS ($I_{B2} = I_C/2$ for all switching)

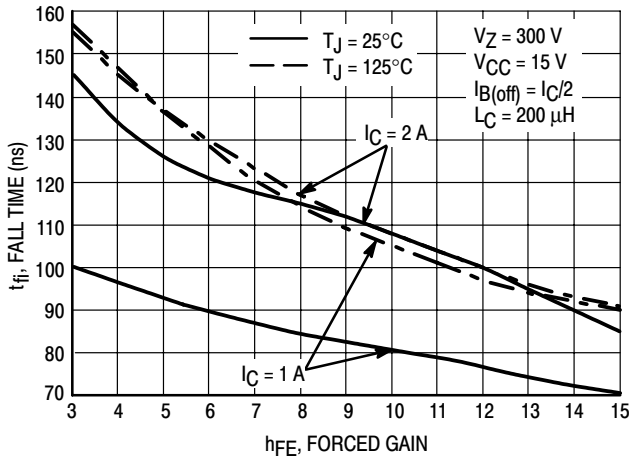

Figure 13. Inductive Fall Time

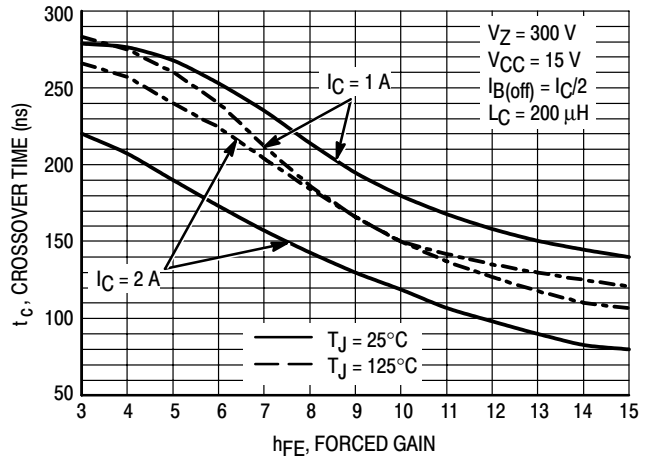

Figure 14. Inductive Crossover Time

GUARANTEED SAFE OPERATING AREA INFORMATION

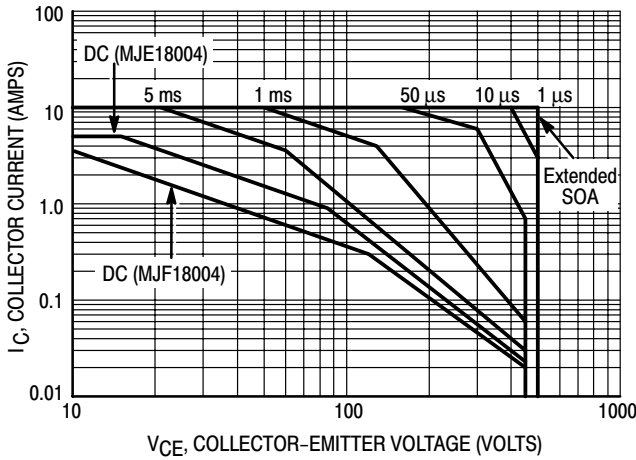

Figure 15. Forward Bias Safe Operating Area

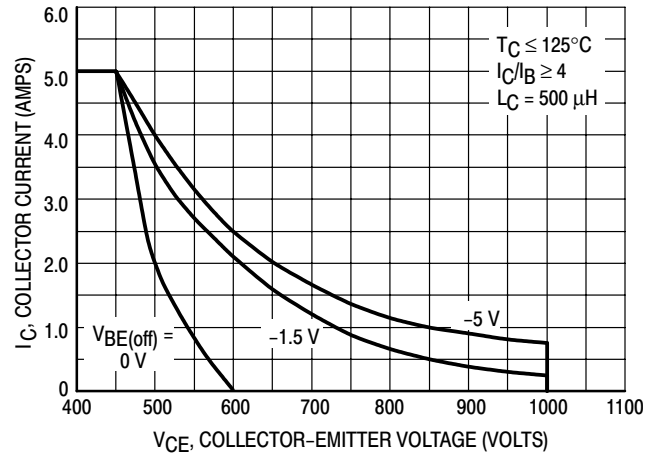

Figure 16. Reverse Bias Safe Operating Area

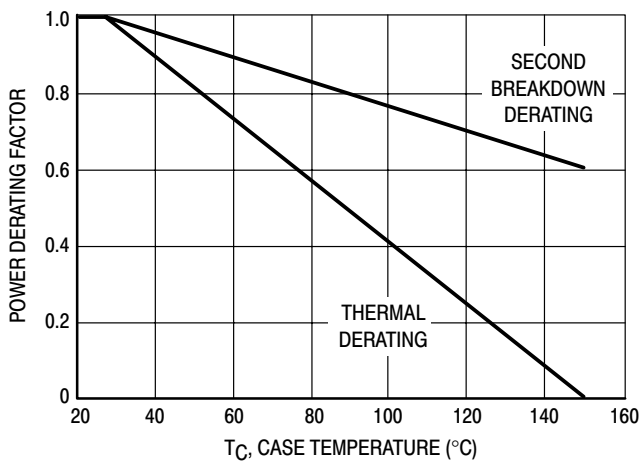

Figure 17. Forward Bias Power Derating

There are two limitations on the power handling ability of a transistor: average junction temperature and second breakdown. Safe operating area curves indicate I_C - V_{CE} limits of the transistor that must be observed for reliable operation; i.e., the transistor must not be subjected to greater dissipation than the curves indicate. The data of Figure 15 is based on $T_C = 25^\circ\text{C}$; $T_J(\text{pk})$ is variable depending on power level. Second breakdown pulse limits are valid for duty cycles to 10% but must be derated when $T_C \geq 25^\circ\text{C}$. Second breakdown limitations do not derate the same as thermal limitations. Allowable current at the voltages shown on Figure 15 may be found at any case temperature by using the appropriate curve on Figure 17. $T_J(\text{pk})$ may be calculated from the data in Figures 20 and 21. At any case temperatures, thermal limitations will reduce the power that can be handled to values less the limitations imposed by second breakdown. For inductive loads, high voltage and current must be sustained simultaneously during turn-off with the base-to-emitter junction reverse biased. The safe level is specified as a reverse-biased safe operating area (Figure 16). This rating is verified under clamped conditions so that the device is never subjected to an avalanche mode.

MJE18004 MJF18004

TYPICAL THERMAL RESPONSE

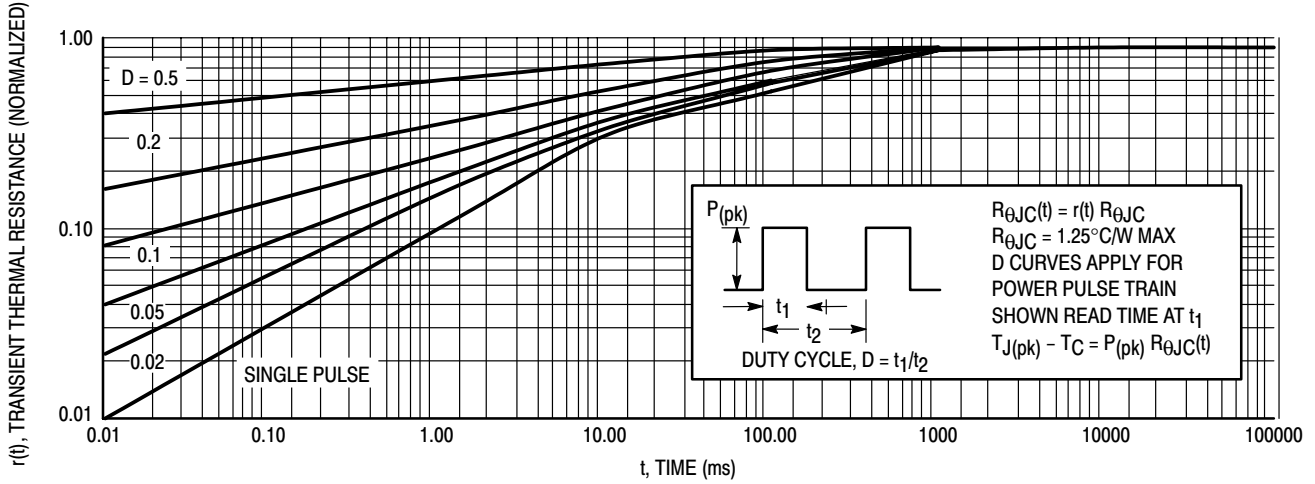

Figure 20. Typical Thermal Response ($Z_{\theta JC}(t)$) for MJE18004

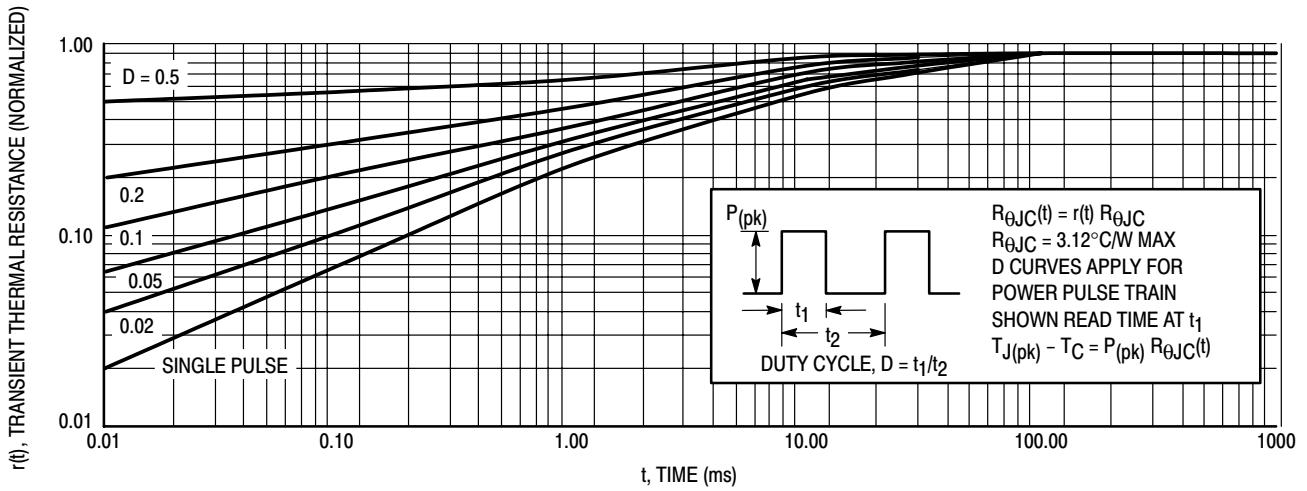

Figure 21. Typical Thermal Response for MJF18004

TEST CONDITIONS FOR ISOLATION TESTS*

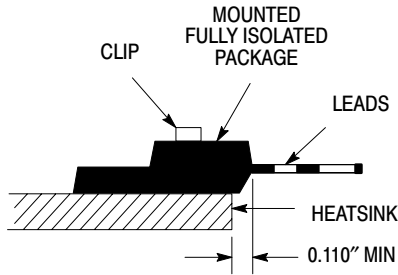

Figure 22a. Screw or Clip Mounting Position for Isolation Test Number 1

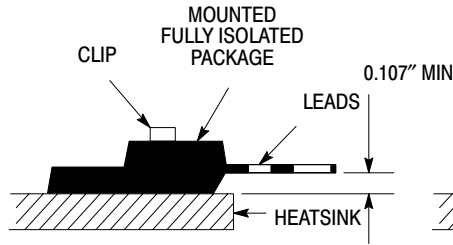

Figure 22b. Clip Mounting Position for Isolation Test Number 2

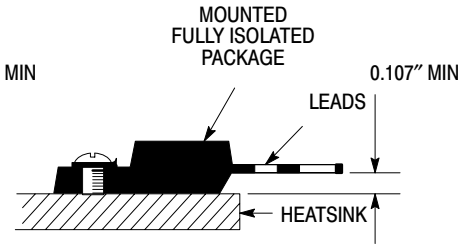

Figure 22c. Screw Mounting Position for Isolation Test Number 3

*Measurement made between leads and heatsink with all leads shorted together

MOUNTING INFORMATION**

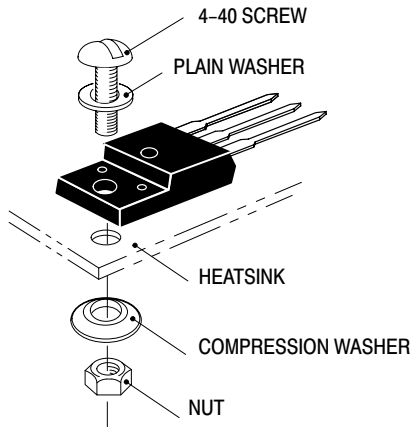

Figure 23a. Screw-Mounted

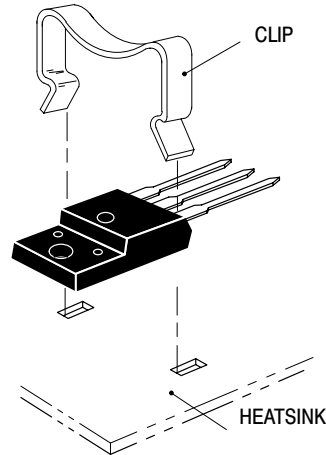

Figure 23b. Clip-Mounted

Figure 23. Typical Mounting Techniques for Isolated Package

Laboratory tests on a limited number of samples indicate, when using the screw and compression washer mounting technique, a screw torque of 6 to 8 in · lbs is sufficient to provide maximum power dissipation capability. The compression washer helps to maintain a constant pressure on the package over time and during large temperature excursions.

Destructive laboratory tests show that using a hex head 4-40 screw, without washers, and applying a torque in excess of 20 in · lbs will cause the plastic to crack around the mounting hole, resulting in a loss of isolation capability.

Additional tests on slotted 4-40 screws indicate that the screw slot fails between 15 to 20 in · lbs without adversely affecting the package. However, in order to positively ensure the package integrity of the fully isolated device, ON Semiconductor does not recommend exceeding 10 in · lbs of mounting torque under any mounting conditions.

** For more information about mounting power semiconductors see Application Note AN1040.

MJE18004 MJF18004

PACKAGE DIMENSIONS

TO-220AB
CASE 221A-09
ISSUE AA

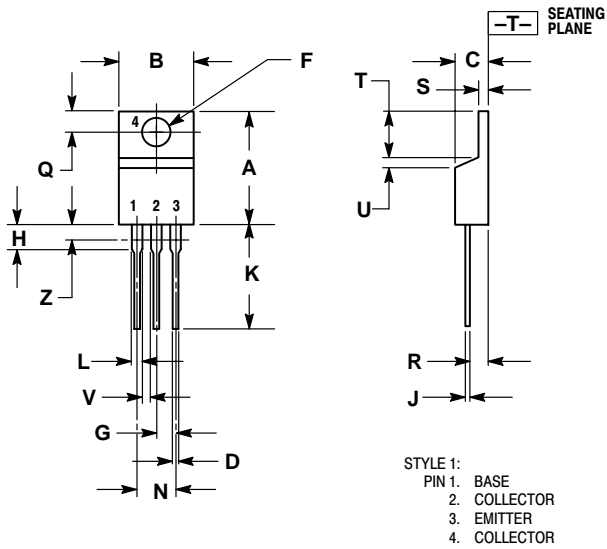

NOTES:

1. DIMENSIONING AND TOLERANCING PER ANSI Y14.5M, 1982.
2. CONTROLLING DIMENSION: INCH.
3. DIMENSION Z DEFINES A ZONE WHERE ALL BODY AND LEAD IRREGULARITIES ARE ALLOWED.

DIM	INCHES		MILLIMETERS	
	MIN	MAX	MIN	MAX
A	0.570	0.620	14.48	15.75
B	0.380	0.405	9.66	10.28
C	0.160	0.190	4.07	4.82
D	0.025	0.035	0.64	0.88
F	0.142	0.147	3.61	3.73
G	0.095	0.105	2.42	2.66
H	0.110	0.155	2.80	3.93
J	0.018	0.025	0.46	0.64
K	0.500	0.562	12.70	14.27
L	0.045	0.060	1.15	1.52
N	0.190	0.210	4.83	5.33
Q	0.100	0.120	2.54	3.04
R	0.080	0.110	2.04	2.79
S	0.045	0.055	1.15	1.39
T	0.235	0.255	5.97	6.47
U	0.000	0.050	0.00	1.27
V	0.045	---	1.15	---
Z	---	0.080	---	2.04

MJE18004 MJF18004

PACKAGE DIMENSIONS

CASE 221D-02
 (ISOLATED TO-220 TYPE)
 UL RECOGNIZED: FILE #E69369
 ISSUE D

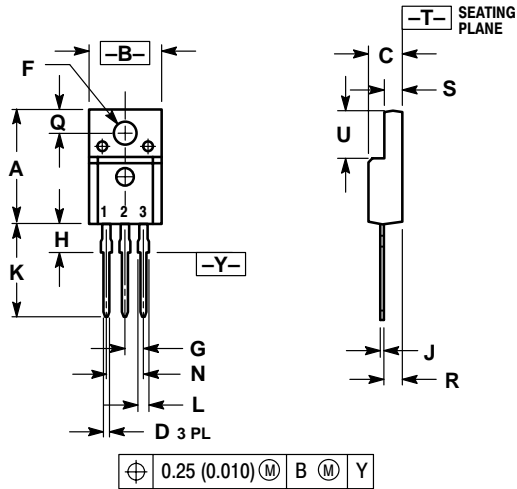

- NOTES:
 1. DIMENSIONING AND TOLERANCING PER ANSI Y14.5M, 1982.
 2. CONTROLLING DIMENSION: INCH.

DIM	INCHES		MILLIMETERS	
	MIN	MAX	MIN	MAX
A	0.621	0.629	15.78	15.97
B	0.394	0.402	10.01	10.21
C	0.181	0.189	4.60	4.80
D	0.026	0.034	0.67	0.86
F	0.121	0.129	3.08	3.27
G	0.100 BSC		2.54 BSC	
H	0.123	0.129	3.13	3.27
J	0.018	0.025	0.46	0.64
K	0.500	0.562	12.70	14.27
L	0.045	0.060	1.14	1.52
N	0.200 BSC		5.08 BSC	
Q	0.126	0.134	3.21	3.40
R	0.107	0.111	2.72	2.81
S	0.096	0.104	2.44	2.64
U	0.259	0.267	6.58	6.78

- STYLE 2:
 PIN 1. BASE
 2. COLLECTOR
 3. EMITTER

SWITCHMODE is a trademark of Semiconductor Components Industries, LLC.

ON Semiconductor and  are registered trademarks of Semiconductor Components Industries, LLC (SCILLC). SCILLC reserves the right to make changes without further notice to any products herein. SCILLC makes no warranty, representation or guarantee regarding the suitability of its products for any particular purpose, nor does SCILLC assume any liability arising out of the application or use of any product or circuit, and specifically disclaims any and all liability, including without limitation special, consequential or incidental damages. "Typical" parameters which may be provided in SCILLC data sheets and/or specifications can and do vary in different applications and actual performance may vary over time. All operating parameters, including "Typicals" must be validated for each customer application by customer's technical experts. SCILLC does not convey any license under its patent rights nor the rights of others. SCILLC products are not designed, intended, or authorized for use as components in systems intended for surgical implant into the body, or other applications intended to support or sustain life, or for any other application in which the failure of the SCILLC product could create a situation where personal injury or death may occur. Should Buyer purchase or use SCILLC products for any such unintended or unauthorized application, Buyer shall indemnify and hold SCILLC and its officers, employees, subsidiaries, affiliates, and distributors harmless against all claims, costs, damages, and expenses, and reasonable attorney fees arising out of, directly or indirectly, any claim of personal injury or death associated with such unintended or unauthorized use, even if such claim alleges that SCILLC was negligent regarding the design or manufacture of the part. SCILLC is an Equal Opportunity/Affirmative Action Employer.

PUBLICATION ORDERING INFORMATION

Literature Fulfillment:

Literature Distribution Center for ON Semiconductor
P.O. Box 5163, Denver, Colorado 80217 USA
Phone: 303-675-2175 or 800-344-3860 Toll Free USA/Canada
Fax: 303-675-2176 or 800-344-3867 Toll Free USA/Canada
Email: ONlit@hibbertco.com

N. American Technical Support: 800-282-9855 Toll Free USA/Canada

JAPAN: ON Semiconductor, Japan Customer Focus Center
4-32-1 Nishi-Gotanda, Shinagawa-ku, Tokyo, Japan 141-0031
Phone: 81-3-5740-2700
Email: r14525@onsemi.com

ON Semiconductor Website: <http://onsemi.com>

For additional information, please contact your local Sales Representative.