

SANYO	No.4224	2SK1691
		N-Channel MOS Silicon FET Very High-Speed Switching Applications

Features

- Low ON resistance.
- Very high-speed switching.

Absolute Maximum Ratings at Ta = 25°C

			unit
Drain to Source Voltage	V_{DSS}	450	V
Gate to Source Voltage	V_{GSS}	± 30	V
Drain Current(DC)	I_D	5	A
Drain Current(Pulse)	I_{DP}	20	A
Allowable Power Dissipation	P_D	1.65	W
		$T_c = 25^\circ\text{C}$	60
Channel Temperature	T_{ch}	150	$^\circ\text{C}$
Storage Temperature	T_{stg}	- 55 to + 150	$^\circ\text{C}$

Electrical Characteristics at Ta = 25°C

			min	typ	max	unit
D-S Breakdown Voltage	$V_{(BR)DSS}$	$I_D = 1\text{mA}, V_{GS} = 0$	450			V
Zero Gate Voltage Drain Current	I_{DSS}	$V_{DS} = 450\text{V}, V_{GS} = 0$			1.0	mA
Gate to Source Leakage Current	I_{GSS}	$V_{GS} = \pm 30\text{V}, V_{DS} = 0$			± 100	nA
Cutoff Voltage	$V_{GS(off)}$	$V_{DS} = 10\text{V}, I_D = 1\text{mA}$	2.0		3.0	V
Forward Transfer Admittance	$ Y_{fs} $	$V_{DS} = 10\text{V}, I_D = 3\text{A}$	2.0	4.0		S
Static Drain to Source on State Resistance	$R_{DS(on)}$	$I_D = 3\text{A}, V_{GS} = 10\text{V}$		1.0	1.4	Ω

Continued on next page.

(Note) Be careful in handling the 2SK1691 because it has no protection diode between gate and source.

Package Dimensions 2093

(unit: mm)

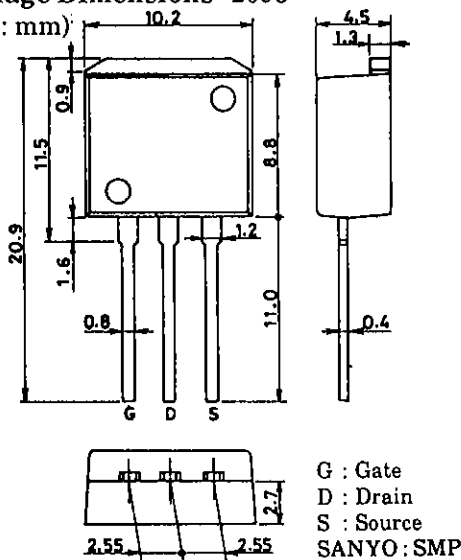

Package Dimensions 2090

(unit: mm)

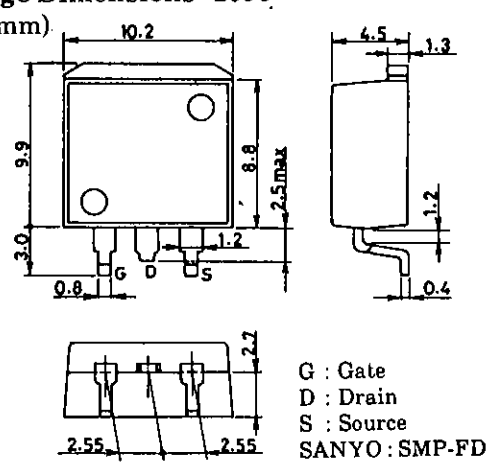

Continued from preceding page.

			min	typ	max	unit
Input Capacitance	C_{iss}	$V_{DS}=20V, f=1MHz$		700		pF
Output Capacitance	C_{oss}	$V_{DS}=20V, f=1MHz$		100		pF
Reverse Transfer Capacitance	C_{rss}	$V_{DS}=20V, f=1MHz$		40		pF
Turn-ON Delay Time	$t_{d(on)}$	See specified Test Circuit.		15		ns
Rise Time	t_r	"		30		ns
Turn-OFF Delay Time	$t_{d(off)}$	"		130		ns
Fall Time	t_f	"		45		ns
Diode Forward Voltage	V_{SD}	$I_S=5A, V_{GS}=0$			1.8	V

Switching Time Test Circuit

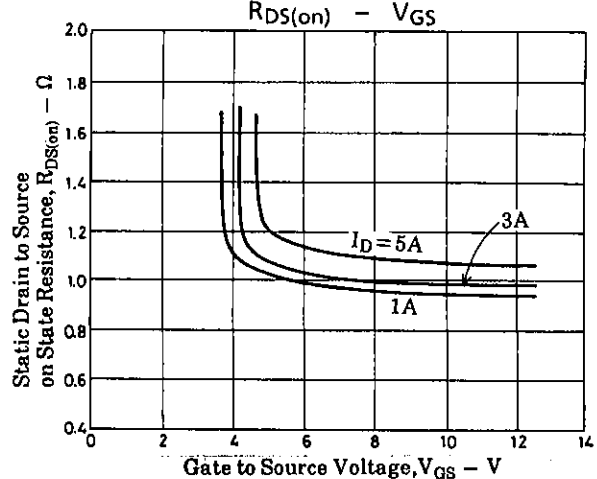
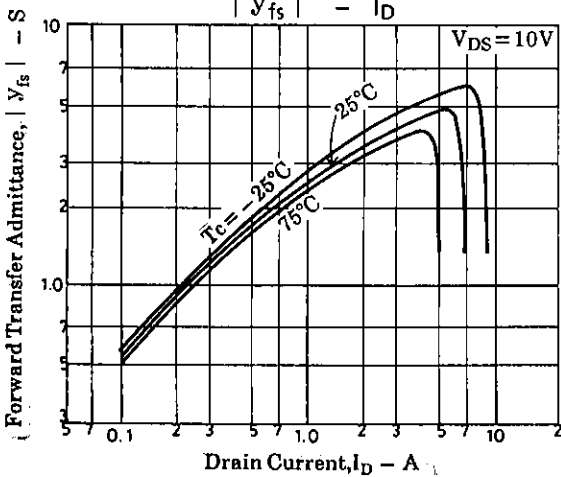
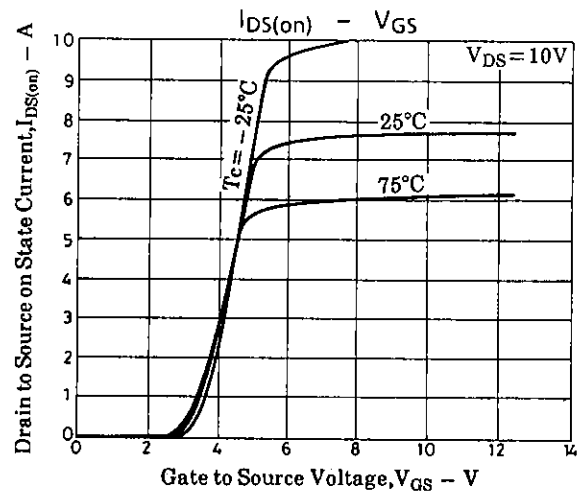
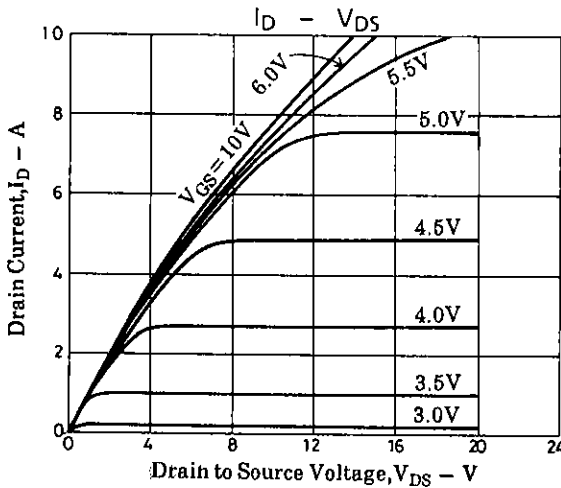
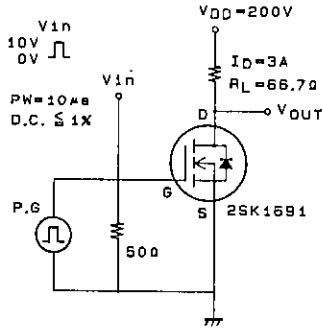

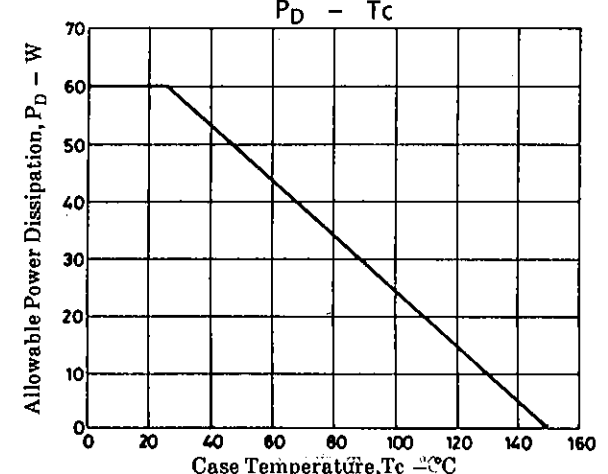
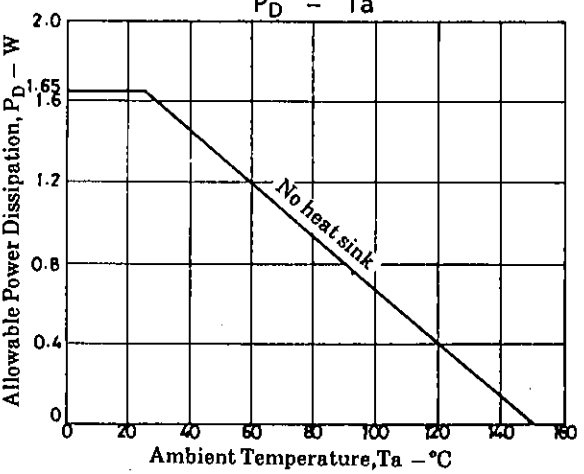
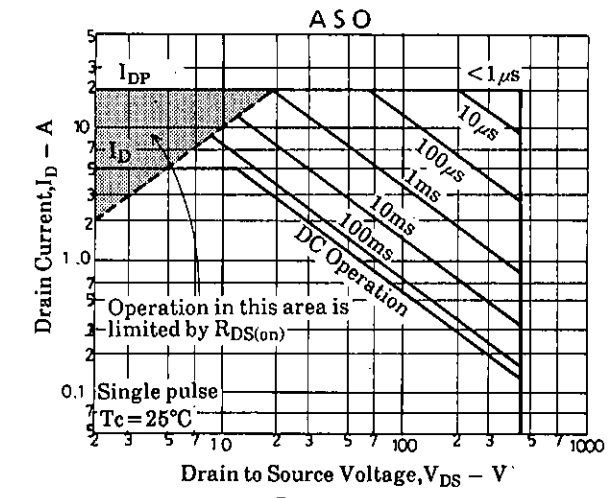
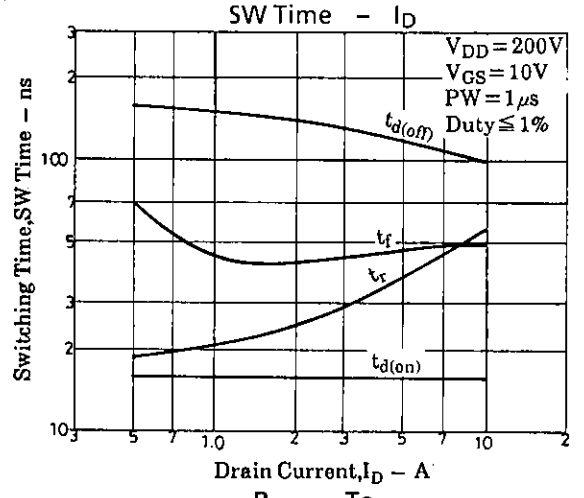
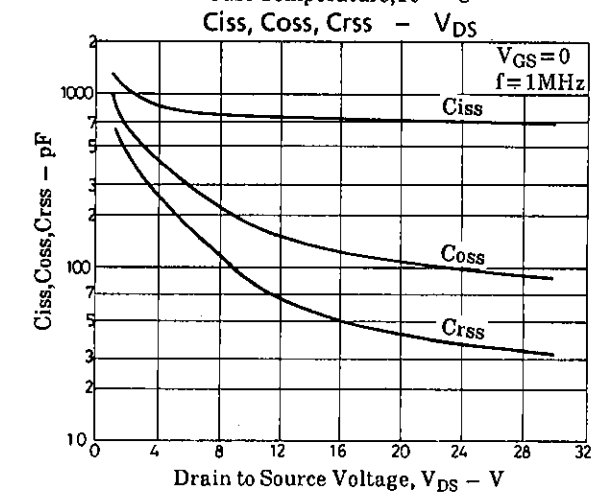
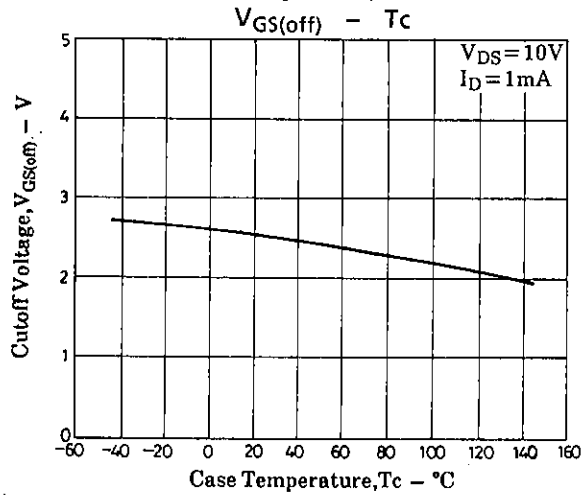
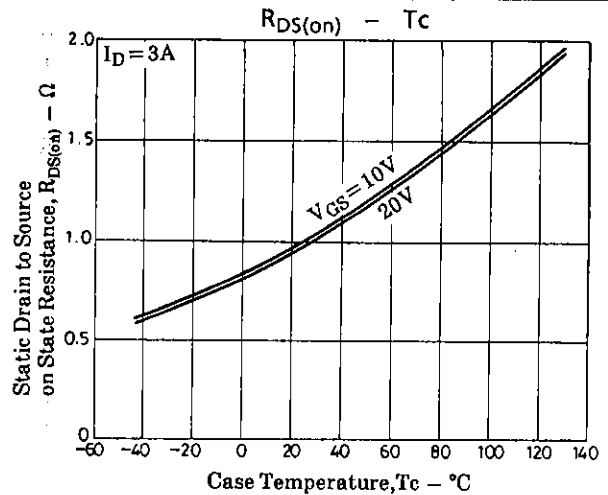
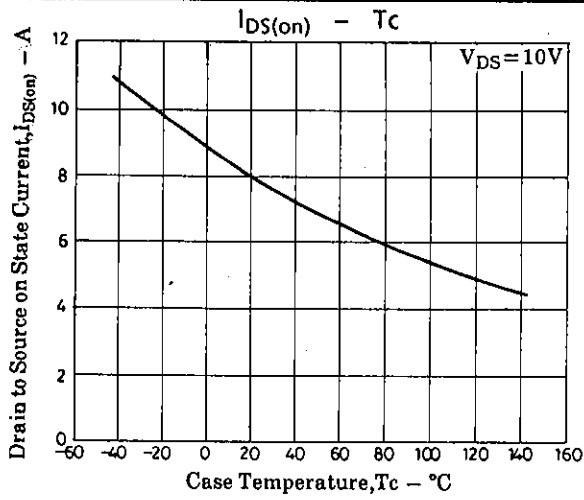

- No products described or contained herein are intended for use in surgical implants, life-support systems, aerospace equipment, nuclear power control systems, vehicles, disaster/crime-prevention equipment and the like, the failure of which may directly or indirectly cause injury, death or property loss.
- Anyone purchasing any products described or contained herein for an above-mentioned use shall:
 - ① Accept full responsibility and indemnify and defend SANYO ELECTRIC CO., LTD., its affiliates, subsidiaries and distributors and all their officers and employees, jointly and severally, against any and all claims and litigation and all damages, cost and expenses associated with such use;
 - ② Not impose any responsibility for any fault or negligence which may be cited in any such claim or litigation on SANYO ELECTRIC CO., LTD., its affiliates, subsidiaries and distributors or any of their officers and employees jointly or severally.
- Information (including circuit diagrams and circuit parameters) herein is for example only; it is not guaranteed for volume production. SANYO believes information herein is accurate and reliable, but no guarantees are made or implied regarding its use or any infringements of intellectual property rights or other rights of third parties.