

HA13119

T-74-05-01

Dual 5.5 W Audio Power Amplifier

The HA13119 is power IC designed for car radio and car stereo amplifiers. At 13.2 V to 4 Ω load, this power IC provides output power of 5.5 W with 10 % distortion.

It is easy to design as this IC employs internal each protection circuit and the new small package.

Features

- Low distortion
 - THD = 0.1 % typ
($P_o = 0.5$ W, $f = 100$ Hz to 10 kHz)
 - THD = 1 % typ
($P_o = 3$ W, $f = 70$ Hz to 40 kHz)
- Internal each protection circuits
 - Surge protection circuit (more than 50 V)
 - Thermal shut-down circuit
 - Ground fault protection circuit
 - Power supply fault protection circuit
- Low external components count

Table 1 Absolute Maximum Ratings ($T_a = 25$ °C)

Item	Symbol	Rating	Unit	Note
Operating supply voltage	V _{cc}	18	V	
DC supply voltage	V _{cc} (DC)	26	V	1
Peak supply voltage	V _{cc} (peak)	50	V	2
Output current	I _o (peak)	4	A	3
Power dissipation	P _T	15	W	4
Thermal resistance	θ_{j-c}	3.5	°C/W	
Junction temperature	T _j	150	°C	
Operating temperature	T _{opr}	-30 to +80	°C	
Storage temperature	T _{stg}	-55 to +125	°C	

- Notes: 1. Value at $t = 30$ sec.
 2. Value at width $t_w = 200$ ms and rise time $t_r = 1$ ms.
 3. Per channel
 4. Per package

Ordering Information

Type No.	Package
HA13119	SP-15T



HA13119

T-74-05-01

Table 2 Electrical Characteristics (V_{CC} = 13.2 V, f = 1 kHz, R_L = 4 Ω, T_a = 25 °C)

1 channel operation

Item	Symbol	Min	Typ	Max	Unit	Test conditions
Quiescent current	I _Q	—	80	160	mA	V _{in} = 0 V
Input bias voltage	V _B	—	—	10	mV	V _{in} = 0 V, R _g = 10 kΩ
Voltage gain	G _v	48	50	52	dB	V _{in} = -50 dBm
Voltage gain difference	ΔG _v	—	—	+1.5	dB	V _{in} = -50 dBm
Output power	P _{out}	5.0	5.5	—	W	R _L = 4 Ω V _{CC} =13.2 V THD = 10 % V _{CC} =14.4 V
Total harmonic distortion	THD	—	0.05	0.5	%	P _{out} = 1.5 W
Wide band noise	WBN	—	0.6	1.2	mV	R _g = 10 kΩ, BW = 20 Hz to 20 kHz
Supply voltage rejection ratio	SVR	35	50	—	dB	R _g = 600 Ω, f = 500 Hz
Input impedance	R _{in}	—	33	—	kΩ	f = 1 kHz, V _{in} = -50 dBm
Roll off frequency	f _L	—	55	—	Hz	ΔG _v = -3 dB Low from
	f _H	—	50	—	kHz	f = 1 kHz Ref High
Cross-talk	C.T	40	55	—	dB	R _g = 600 Ω, V _{in} = -50 dBm

2 channel operation

Item	Symbol	Min	Typ	Max	Unit	Test conditions
Output power	P _{out}	—	5.3	—	W	THD = 10 %
Total harmonic distortion	THD	—	0.10	—	%	P _{out} = 1.5 W



Typical Application Circuit

T-74-05-01

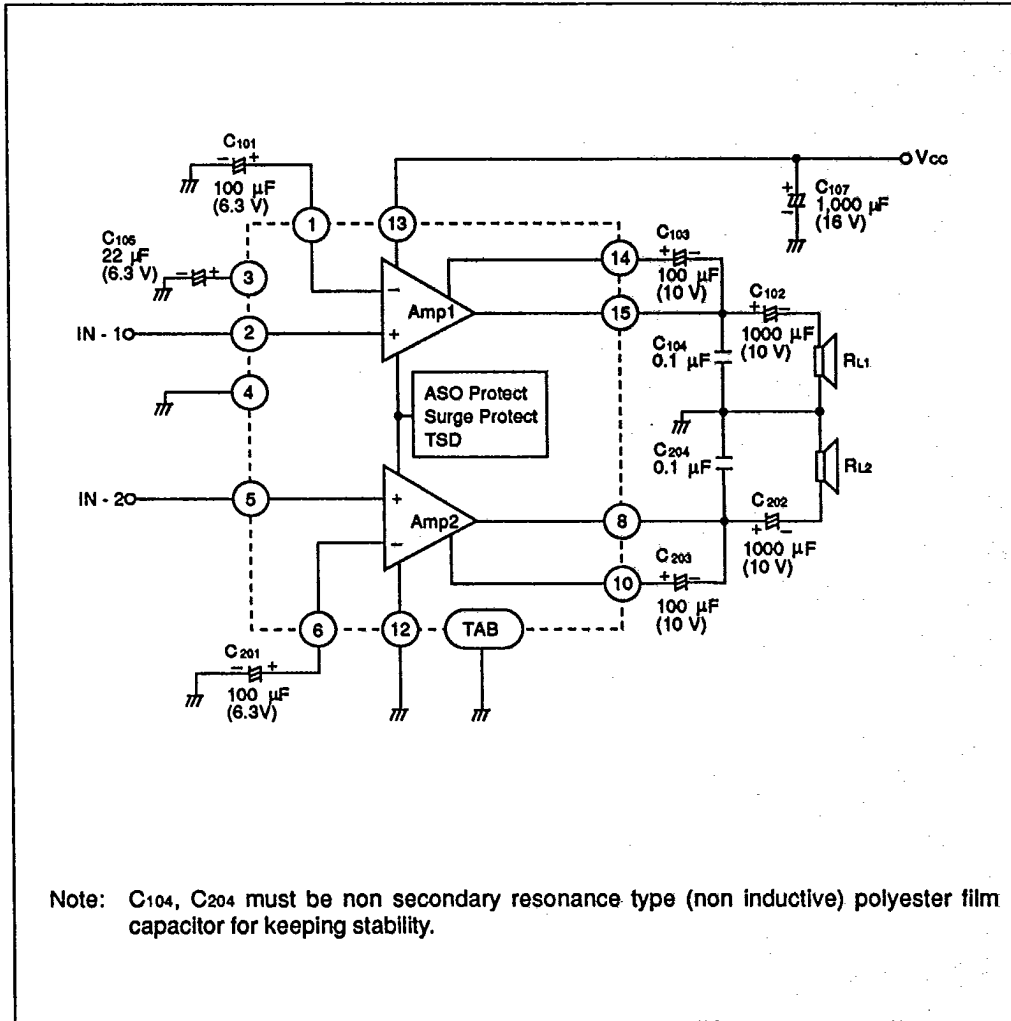

Note: C104, C204 must be non secondary resonance type (non inductive) polyester film capacitor for keeping stability.



HA13119

T-74-05-01

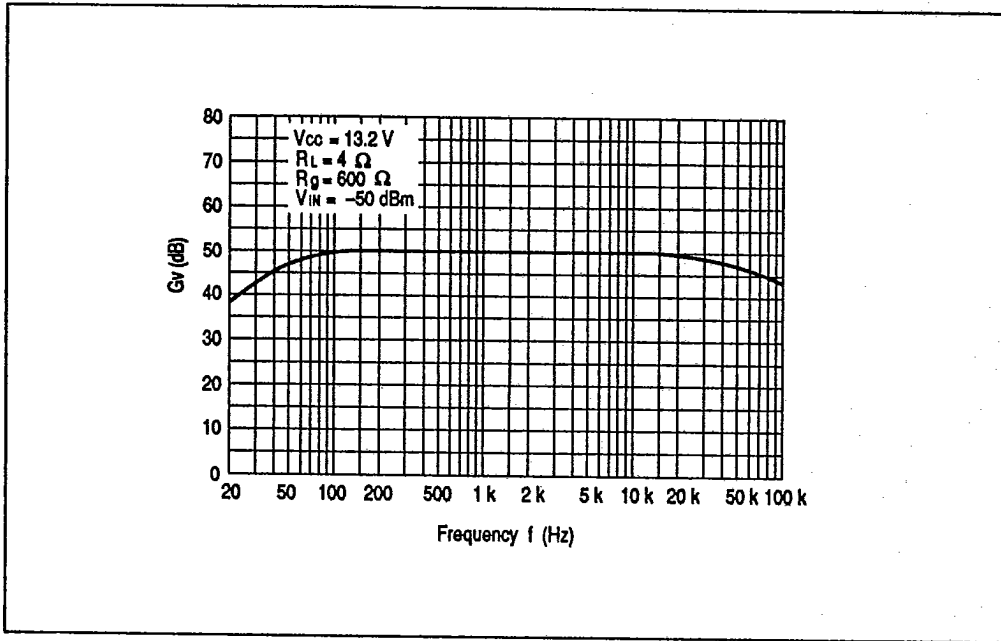

Voltage Gain vs. Frequency

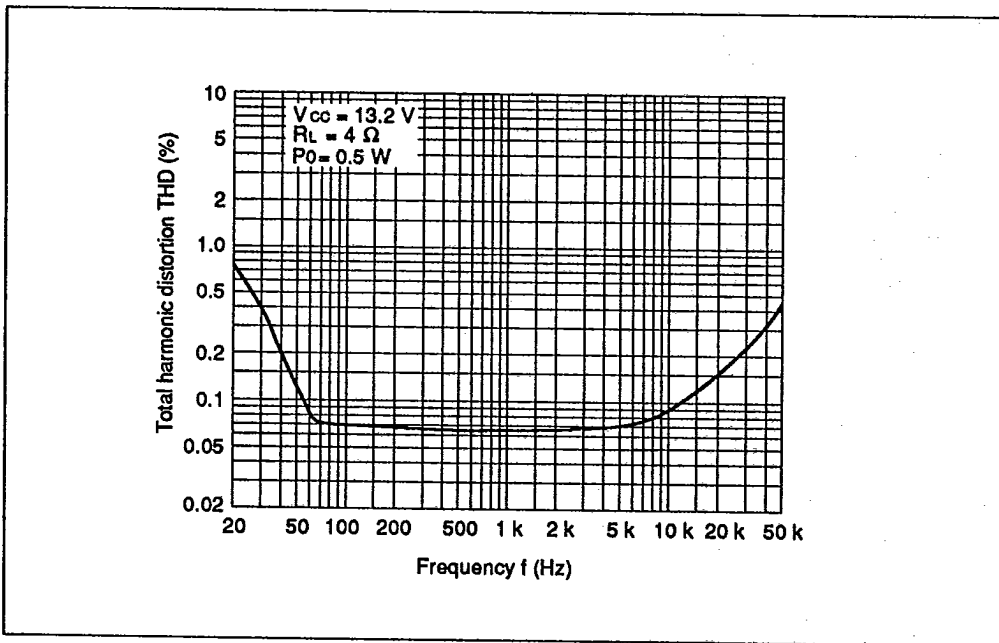

Total Harmonic Distortion vs. Frequency



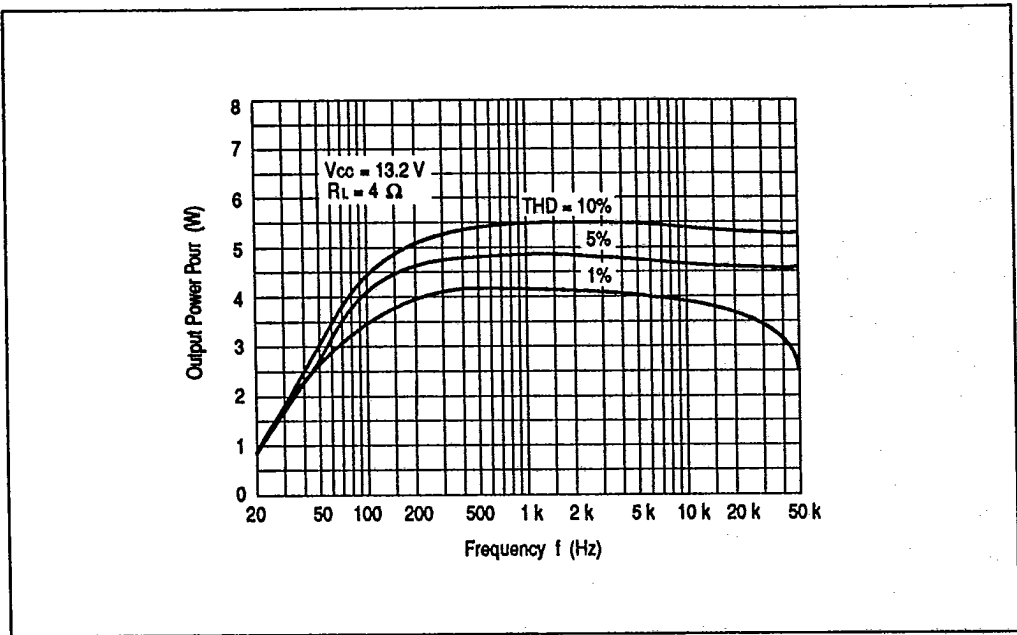

Output Power vs. Frequency

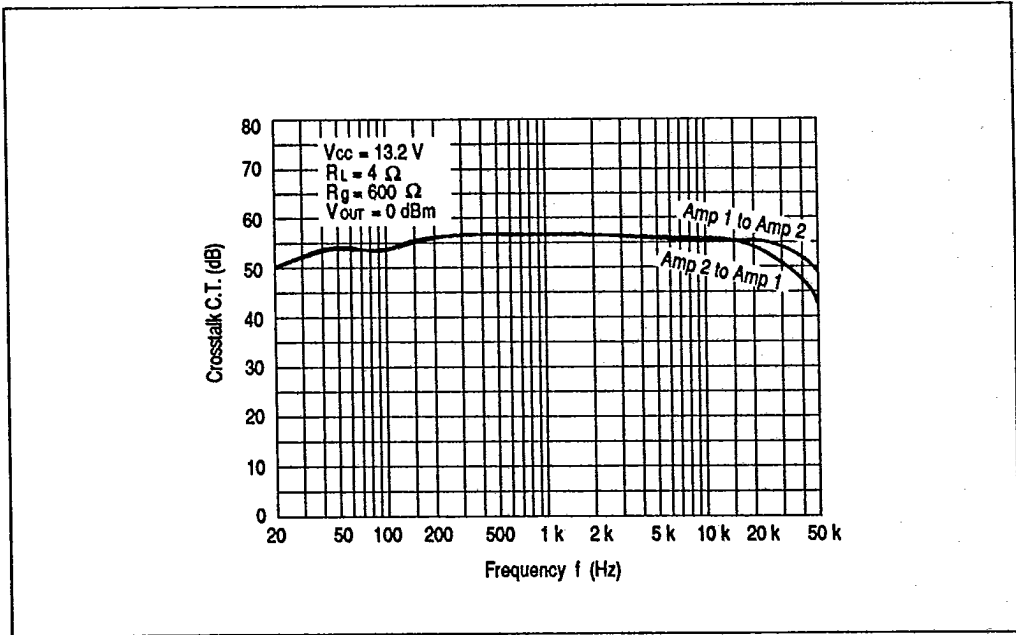

Cross-talk vs. Frequency



HA13119

T-74-05-01

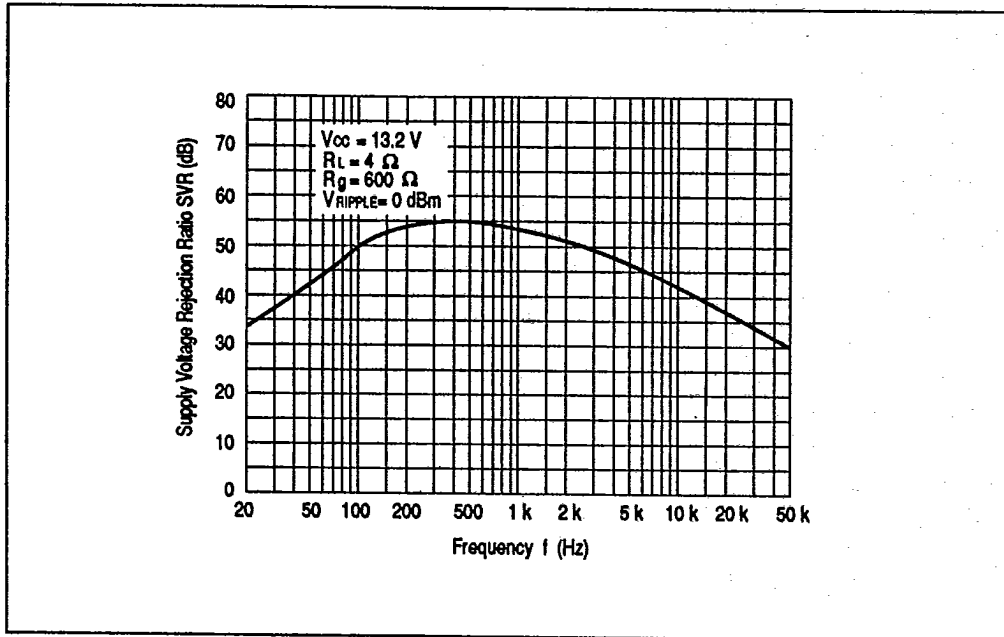

Supply Voltage Rejection Ratio vs. Frequency

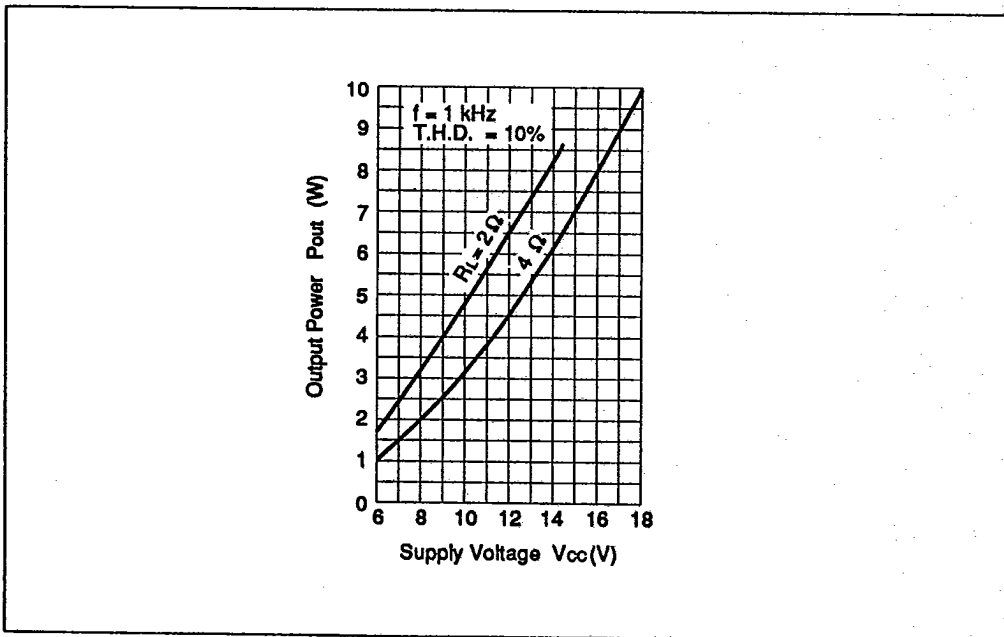

Output Power vs. Supply Voltage



T-74-05-01

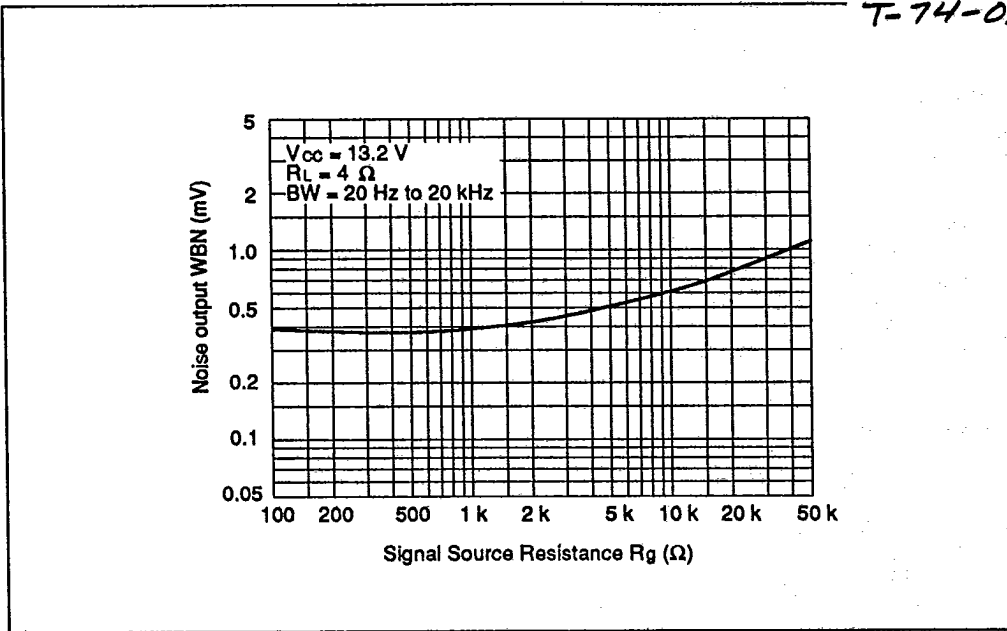

Noise Output vs. Signal Source Resistance

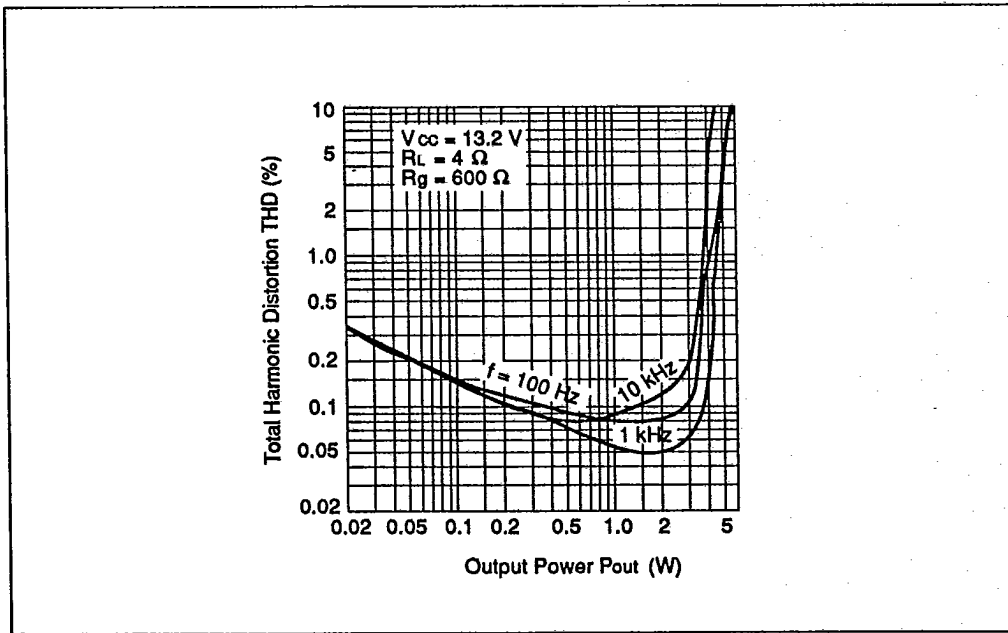

Total Harmonic Distortion vs. Output Power



HA13119

T-74-05-01

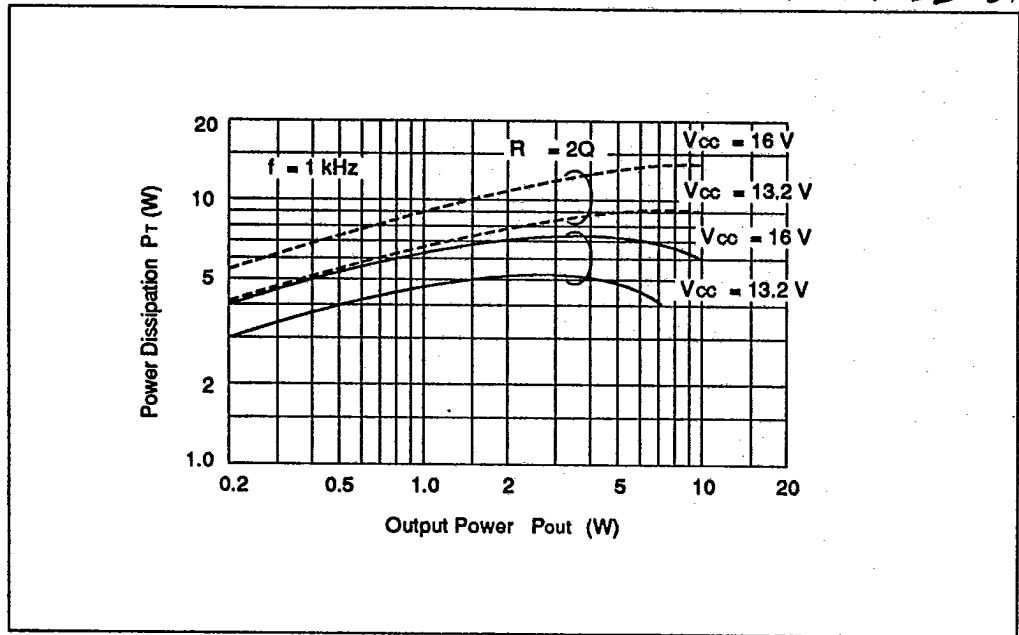

Power Dissipation vs. Output Power

