

HD14027B

Dual J-K Flip Flop

The HD14027B dual J-K flip-flop has independent J, K, Clock (C), Set(S) and Reset(R) inputs for each flip-flop. These devices may be used in control, register, or toggle functions.

FEATURES

- Quiescent Current = 2nA/pkg typ. @5V
- Supply Voltage Range = 3 to 18V
- Toggle Rate = 3MHz typ. @5V
- Capable of Driving One Low-power Schottky TTL Load Over the Rated Temperature Range
- Pin-for-Pin Replacement for CD4027B and MC14027B

LOGIC DIAGRAM (1/2)

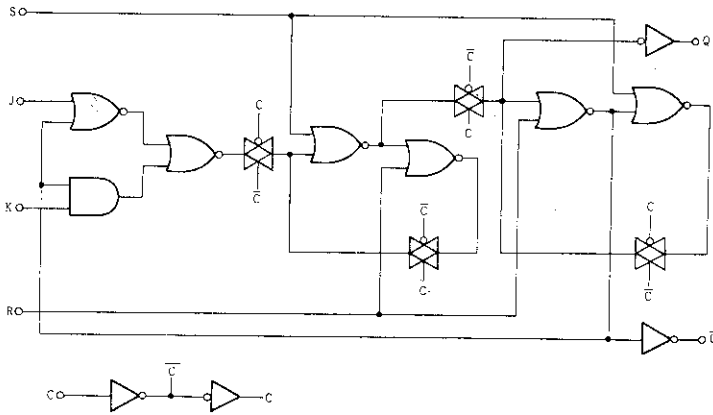

PIN ARRANGEMENT

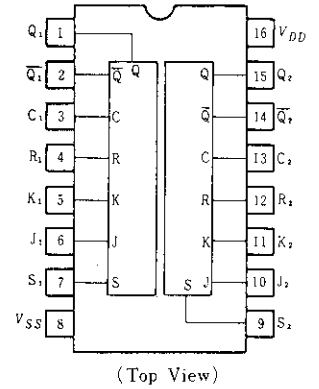

TRUTH TABLE

Inputs						Outputs**	
C †	J	K	S	R	Qn*	Qn+1	Qn+1
↗	1	x	0	0	0	1	0
↗	x	0	0	0	1	1	0
↗	0	x	0	0	0	0	1
↗	x	1	0	0	1	0	1
↘	x	x	0	0	x	Qn	Qn
x	x	x	1	0	x	1	0
x	x	x	0	1	x	0	1
x	x	x	1	1	x	1	1

- x=Don't Care
- † Level Change
- **Next State
- *Present State

■ ELECTRICAL CHARACTERISTICS

Characteristic	Symbol	V _{DD} (V)	Test Conditions	-40°C		25°C			85°C		Unit
				min	max	min	typ	max	min	max	
Output Voltage	V _{OL}	5.0		-	0.05	-	0	0.05	-	0.05	V
		10		-	0.05	-	0	0.05	-	0.05	
		15		-	0.05	-	0	0.05	-	0.05	
	V _{OH}	5.0		4.95	-	4.95	5.0	-	4.95	-	V
		10		9.95	-	9.95	10	-	9.95	-	
		15		14.95	-	14.95	15	-	14.95	-	
Input Voltage	V _{IL}	5.0	V _{out} =4.5 or 0.5V	-	1.5	-	2.25	1.5	-	1.5	V
		10	V _{out} =9.0 or 1.0V	-	3.0	-	4.50	3.0	-	3.0	
		15	V _{out} =13.5 or 1.5V	-	4.0	-	6.75	4.0	-	4.0	
	V _{IH}	5.0	V _{out} =0.5 or 4.5V	3.7	-	3.5	2.75	-	3.5	-	V
		10	V _{out} =1.0 or 9.0V	7.0	-	7.0	5.50	-	7.0	-	
		15	V _{out} =1.5 or 13.5V	11.0	-	11.0	8.25	-	11.0	-	
Output Drive Current	I _{OH}	5.0	V _{OH} =2.5V	-1.0	-	-0.8	-1.7	-	-0.6	-	mA
		5.0	V _{OH} =4.6V	-0.2	-	-0.16	-0.36	-	-0.12	-	
		10	V _{OH} =9.5V	-0.5	-	-0.4	-0.9	-	-0.3	-	
		15	V _{OH} =13.5V	-1.4	-	-1.2	-3.5	-	-1.0	-	
	I _{OL}	5.0	V _{OL} =0.4V	0.52	-	0.44	0.88	-	0.36	-	mA
		10	V _{OL} =0.5V	1.3	-	1.1	2.25	-	0.9	-	
15		V _{OL} =1.5V	3.6	-	3.0	8.8	-	2.4	-		
Input Current	I _{in}	15		-	±0.3	-	±0.0001	+0.3	-	±1.0	μA
Input Capacitance	C _{in}		V _{in} =0	-	-	-	5.0	7.5	-	-	pF
Quiescent Current	I _{DD}	5.0	Zero Signal, per Package	-	4.0	-	0.002	4.0	-	30	μA
		10		-	8.0	-	0.004	8.0	-	60	
		15		-	16	-	0.006	16	-	120	
Total Supply Current*	I _T	5.0	Dynamic + I _{DD} ,	-	-	-	0.8	-	-	-	μA
		10	per Gate	-	-	-	1.6	-	-	-	
		15	C _L =50pF, f = 1 kHz	-	-	-	2.4	-	-	-	

* To calculate total supply current at frequency other than 1kHz.
 @ V_{DD}=5.0V I_T=(0.80μA/kHz)f+I_{DD} @ V_{DD}=10V I_T=(1.60μA/kHz)f+I_{DD} @ V_{DD}=15V I_T=(2.40μA/kHz)f+I_{DD}

■ SWITCHING CHARACTERISTICS ($C_L=50\text{pF}$, $T_a=25^\circ\text{C}$)

Characteristic		Symbol	$V_{DD}(\text{V})$	min	typ	max	Unit
Output Rise Time		t_r	5.0	—	180	360	ns
			10	—	90	180	
			15	—	65	130	
Output Fall Time		t_f	5.0	—	135	260	ns
			10	—	65	130	
			15	—	50	100	
Propagation Delay Time	Clock	t_{PLH} , t_{PHL}	5.0	—	280	400	ns
			10	—	120	200	
			15	—	95	150	
	Set		5.0	—	230	350	
			10	—	100	150	
			15	—	80	130	
	Reset		5.0	—	350	450	
			10	—	100	200	
			15	—	75	150	
Setup Time		$t_{setup H}$ $t_{setup L}$	5.0	140	70	—	ns
			10	50	25	—	
			15	35	17	—	
Clock Pulse Width		PW_{CH} PW_{CL}	5.0	330	165	—	ns
			10	110	55	—	
			15	75	38	—	
Clock Frequency		PRF	5.0	—	3.0	1.5	MHz
			10	—	9.0	4.5	
			15	—	13	6.5	
Clock Pulse Rise and Fall Time		t_r , t_f	5.0	—	—	15	μs
			10	—	—	5.0	
			15	—	—	4.0	
Set and Reset Pulse Width		PW_S , PW_R	5.0	250	125	—	ns
			10	100	50	—	
			15	70	35	—	

■ DYNAMIC SIGNAL WAVEFORMS

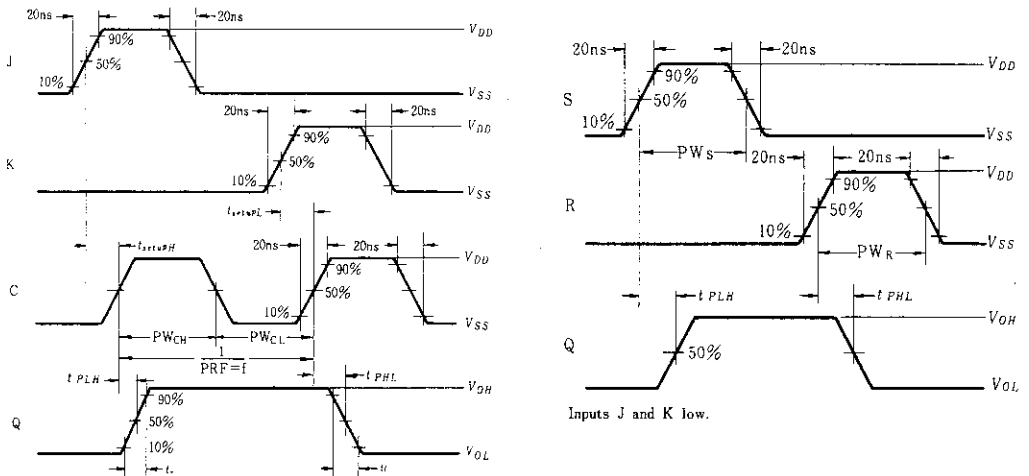

Inputs R and S low. For the measurement of PW_C , PRF, and P_D the inputs, J and K are kept high.

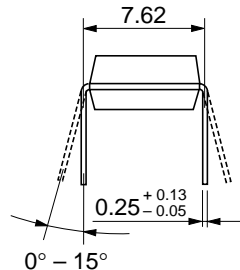
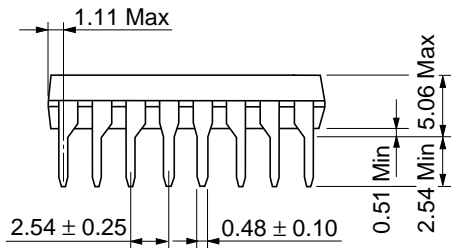
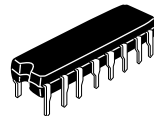
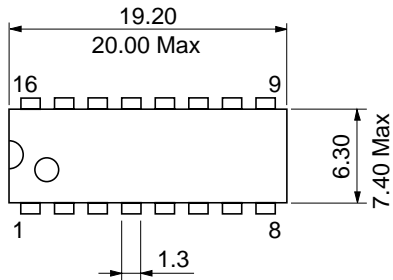

Hitachi Code	DP-16
JEDEC	Conforms
EIAJ	Conforms
Weight (reference value)	1.07 g

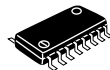

*Dimension including the plating thickness
Base material dimension

Hitachi Code	FP-16DA
JEDEC	—
EIAJ	Conforms
Weight (reference value)	0.24 g



*Dimension including the plating thickness
Base material dimension

Hitachi Code	FP-16DN
JEDEC	Conforms
EIAJ	Conforms
Weight (reference value)	0.15 g

Cautions

1. Hitachi neither warrants nor grants licenses of any rights of Hitachi's or any third party's patent, copyright, trademark, or other intellectual property rights for information contained in this document. Hitachi bears no responsibility for problems that may arise with third party's rights, including intellectual property rights, in connection with use of the information contained in this document.
2. Products and product specifications may be subject to change without notice. Confirm that you have received the latest product standards or specifications before final design, purchase or use.
3. Hitachi makes every attempt to ensure that its products are of high quality and reliability. However, contact Hitachi's sales office before using the product in an application that demands especially high quality and reliability or where its failure or malfunction may directly threaten human life or cause risk of bodily injury, such as aerospace, aeronautics, nuclear power, combustion control, transportation, traffic, safety equipment or medical equipment for life support.
4. Design your application so that the product is used within the ranges guaranteed by Hitachi particularly for maximum rating, operating supply voltage range, heat radiation characteristics, installation conditions and other characteristics. Hitachi bears no responsibility for failure or damage when used beyond the guaranteed ranges. Even within the guaranteed ranges, consider normally foreseeable failure rates or failure modes in semiconductor devices and employ systemic measures such as fail-safes, so that the equipment incorporating Hitachi product does not cause bodily injury, fire or other consequential damage due to operation of the Hitachi product.
5. This product is not designed to be radiation resistant.
6. No one is permitted to reproduce or duplicate, in any form, the whole or part of this document without written approval from Hitachi.
7. Contact Hitachi's sales office for any questions regarding this document or Hitachi semiconductor products.

HITACHI

Hitachi, Ltd.

Semiconductor & Integrated Circuits.
Nippon Bldg., 2-6-2, Ohte-machi, Chiyoda-ku, Tokyo 100-0004, Japan
Tel: Tokyo (03) 3270-2111 Fax: (03) 3270-5109

URL North America : <http://semiconductor.hitachi.com/>
Europe : <http://www.hitachi-eu.com/hel/ecg>
Asia (Singapore) : <http://www.has.hitachi.com.sg/grp3/sicd/index.htm>
Asia (Taiwan) : http://www.hitachi.com.tw/E/Product/SICD_Frame.htm
Asia (HongKong) : <http://www.hitachi.com.hk/eng/bo/grp3/index.htm>
Japan : <http://www.hitachi.co.jp/Sicd/indx.htm>

For further information write to:

Hitachi Semiconductor
(America) Inc.
179 East Tasman Drive,
San Jose, CA 95134
Tel: <1> (408) 433-1990
Fax: <1> (408) 433-0223

Hitachi Europe GmbH
Electronic components Group
Dornacher Straße 3
D-85622 Feldkirchen, Munich
Germany
Tel: <49> (89) 9 9180-0
Fax: <49> (89) 9 29 30 00

Hitachi Europe Ltd.
Electronic Components Group.
Whitebrook Park
Lower Cookham Road
Maidenhead
Berkshire SL6 8YA, United Kingdom
Tel: <44> (1628) 585000
Fax: <44> (1628) 778322

Hitachi Asia Pte. Ltd.
16 Collyer Quay #20-00
Hitachi Tower
Singapore 049318
Tel: 535-2100
Fax: 535-1533

Hitachi Asia Ltd.
Taipei Branch Office
3F, Hung Kuo Building, No.167,
Tun-Hwa North Road, Taipei (105)
Tel: <886> (2) 2718-3666
Fax: <886> (2) 2718-8180

Hitachi Asia (Hong Kong) Ltd.
Group III (Electronic Components)
7/F., North Tower, World Finance Centre,
Harbour City, Canton Road, Tsim Sha Tsui,
Kowloon, Hong Kong
Tel: <852> (2) 735 9218
Fax: <852> (2) 730 0281
Telex: 40815 HITEC HX

Copyright ' Hitachi, Ltd., 1999. All rights reserved. Printed in Japan.

HITACHI