

M5278LXX, M5278LXXM

(5V, 5.6V, 8V, 9V, 10V, 12V, 15V) 3-TERMINAL FIXED POSITIVE OUTPUT VOLTAGE REGULATOR (WITH FOLD-BACK PROTECTION CIRCUIT)

DESCRIPTION

The M5278L series consists of monolithic integrated circuits, each a three-terminal regulator with maximum load capabilities of 100mA and featuring output voltages of 5, 5.6, 8, 9, 10, 12, or 15V. The high-performance, fixed-positive output power supply ICs are packaged in 3-pin packages featuring fold-back protective circuits for limiting current when load short. They are especially appropriate for use in personal computers and general power supplies of electrical appliances.

FEATURES

- Interchangeable with other brand 78L series
..... $I_{Lmax}=100mA$
- Internal fold-back protection circuit limits current due to shorted loads.
M5278L05 16.5mA (typ.) (1/10 that of other brands)
- High ripple division factor
M5278L05 73dB (typ.)
- Low output voltage tolerance $\pm 5\%$ (max.)
- High level of permissible internal heat dissipation
..... 900mW (max.) 3P5
..... 500mW (max.) 3P2

PIN CONFIGURATION

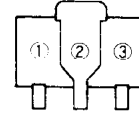
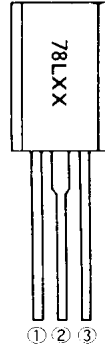

Outline EIAJ: TO-92L

Outline SOT-89

ELECTRODE CONNECTION

- ① : OUTPUT
- ② : GND
- ③ : INPUT

ELECTRODE CONNECTION

- ① : INPUT
- ② : GND
- ③ : OUTPUT

APPLICATION

Power supply for microcomputer in VTR equipment, general power supply for electronic equipment of tape decks, car stereo equipment and radio cassette recorder.

M5278LXX blank... 3P5 pkg.
M..... 3P2 pkg.
OUTPUT VOLTAGE VALUE

Type	Marking		Output voltage
	3P5	3P2	
M5278L05	78L05	MA	5V
M5278L56	78L56	MB	5.6V
M5278L10	78L10	MF	10V
M5278L12	78L12	MG	12V

Type	Marking		Output voltage
	3P5	3P2	
M5278L08	78L08	MD	8V
M5278L09	78L09	ME	9V
M5278L15	78L15	MH	15V

BLOCK DIAGRAM

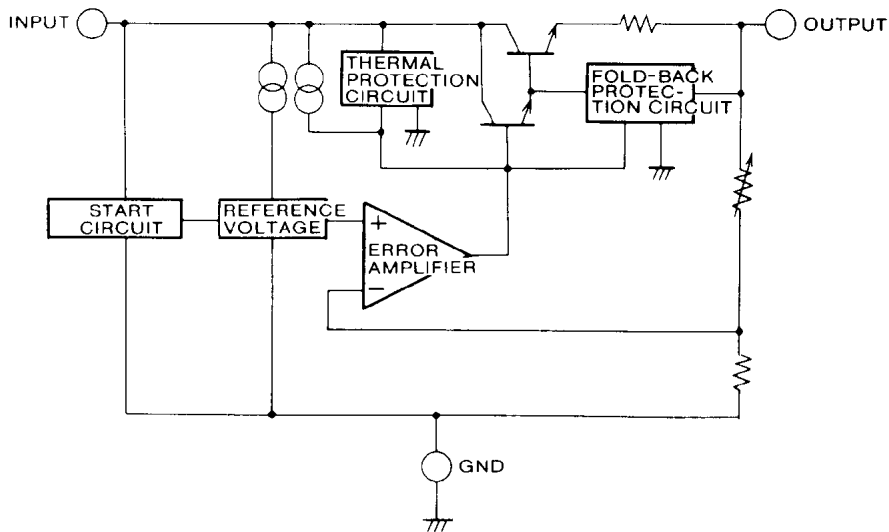

M5278LXX, M5278LXXM

(5V, 5.6V, 8V, 9V, 10V, 12V, 15V) 3-TERMINAL FIXED POSITIVE OUTPUT VOLTAGE REGULATOR (WITH FOLD-BACK PROTECTION CIRCUIT)

ABSOLUTE MAXIMUM RATINGS (T_a=25°C)

Symbol	Parameter	Ratings	Unit
V _i	Input voltage	36	V
I _L	Load current	100	mA
P _d	Power dissipation	900(3P5)/500(3P2)	mW
T _{opr}	Operating temperature	-20~+75	°C
T _{stg}	Storage temperature	-55~+150	°C

STANDARD CONNECTION

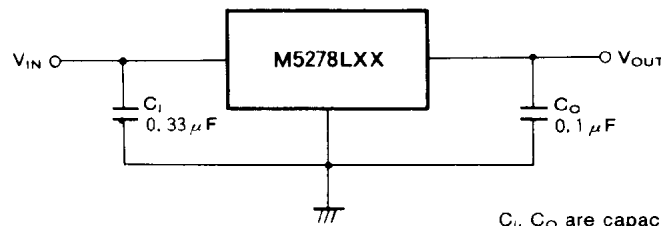

C₁, C₀ are capacitors to prevent oscillation. Make connections as close to the IC as possible.

ELECTRICAL CHARACTERISTICS

M5278L05 (V_i=10V, I_L=40mA, T_a=25°C, C₁=0.33 μF, C₀=0.1 μF, unless otherwise noted)

Symbol	Parameter	Test conditions	Limits			Unit
			Min	Typ	Max	
V _O	Output voltage		4.75	5.0	5.25	V
R _{reg-in}	Input regulation	7.5V ≤ V _i ≤ 20V		50	200	mV
		8V ≤ V _i ≤ 20V		30	150	
R _{reg-L}	Load regulation	1mA ≤ I _L ≤ 100mA		10	60	mV
		1mA ≤ I _L ≤ 40mA		5	30	
V _O	Output voltage	7.5V ≤ V _i ≤ 20V, 1mA ≤ I _L ≤ 40mA	4.7	5.0	5.3	V
		V _i =10V, 1mA ≤ I _L ≤ 70mA	4.7	5.0	5.3	
I _B	Bias current	I _L =0		4.8	6.7	mA
ΔI _B	Bias current variability	8V ≤ V _i ≤ 20V, I _L =40mA		0.1	1.5	mA
		V _i =10V, 1mA ≤ I _L ≤ 40mA			0.2	
V _{NO}	Output noise voltage	BW: 10Hz~100kHz		49		μV _{rms}
RR	Ripple rejection ratio	f=120Hz, V _{in} =0dBm	63	73		dB
V _i -V _O	Minimum input-output voltage difference			2.0		V
I _{LP}	Peak load current			130		mA
I _{OS}	Output short holding current			16.5		mA
TC _{VO}	Temperature coefficient of output voltage	I _L =5mA		-0.6		mV/°C

MITSUBISHI <LINEAR ICs>
M5278LXX, M5278LXXM

**(5V, 5.6V, 8V, 9V, 10V, 12V, 15V) 3-TERMINAL FIXED POSITIVE
OUTPUT VOLTAGE REGULATOR (WITH FOLD-BACK PROTECTION CIRCUIT)**

M5278L56 ($V_I=11V, I_L=40mA, T_a=25^\circ C, C_I=0.33\mu F, C_O=0.1\mu F$, unless otherwise noted)

Symbol	Parameter	Test conditions	Limits			Unit
			Min	Typ	Max	
V_O	Output voltage		5.32	5.6	5.88	V
R_{reg-in}	Input regulation	$8.5V \leq V_I \leq 21V$		50	200	mV
		$9V \leq V_I \leq 21V$		30	150	
R_{reg-L}	Load regulation	$1mA \leq I_L \leq 100mA$		10	60	mV
		$1mA \leq I_L \leq 40mA$		5	30	
V_O	Output voltage	$8.5V \leq V_I \leq 21V, 1mA \leq I_L \leq 40mA$	5.27	5.6	5.93	V
		$V_I=11V, 1mA \leq I_L \leq 70mA$	5.27	5.6	5.93	
I_B	Bias current	$I_L=0$		4.8	6.7	mA
ΔI_B	Bias current differential	$9V \leq V_I \leq 21V, I_L=40mA$		0.1	1.5	mA
		$V_I=11V, 1mA \leq I_L \leq 40mA$			0.2	
V_{NO}	Output noise voltage	BW: 10Hz~100kHz		55		μV_{rms}
RR	Ripple rejection ratio	$f=120Hz, V_{in}=0dBm$	63	73		dB
V_I-V_O	Minimum input-output voltage difference			2.0		V
I_{LP}	Peak load current			150		mA
I_{OS}	Output short circuit sustain current			16.5		mA
TC_{VO}	Temperature coefficient of output voltage	$I_L=5mA$		-0.65		mV/°C

M5278L08 ($V_I=14V, I_L=40mA, T_a=25^\circ C, C_I=0.33\mu F, C_O=0.1\mu F$, unless otherwise noted)

Symbol	Parameter	Test conditions	Limits			Unit
			Min	Typ	Max	
V_O	Output voltage		7.6	8.0	8.4	V
R_{reg-in}	Input regulation	$10.5V \leq V_I \leq 23V$		60	200	mV
		$11V \leq V_I \leq 23V$		40	150	
R_{reg-L}	Load regulation	$1mA \leq I_L \leq 100mA$		10	80	mV
		$1mA \leq I_L \leq 40mA$		5	40	
V_O	Output voltage	$10.5V \leq V_I \leq 23V, 1mA \leq I_L \leq 40mA$	7.52	8.0	8.48	V
		$V_I=14V, 1mA \leq I_L \leq 70mA$	7.52	8.0	8.48	
I_B	Bias current	$I_L=0$		4.8	6.7	mA
ΔI_B	Bias current differential	$10.5V \leq V_I \leq 23V, I_L=40mA$		0.1	1.5	mA
		$V_I=14V, 1mA \leq I_L \leq 40mA$			0.2	
V_{NO}	Output noise voltage	BW: 10Hz~100kHz		80		μV_{rms}
RR	Ripple rejection ratio	$f=120Hz, V_{in}=0dBm$		56		dB
V_I-V_O	Minimum input-output voltage difference			2.0		V
I_{LP}	Peak load current			150		mA
I_{OS}	Output short circuit sustain current			12.5		mA
TC_{VO}	Temperature coefficient of output voltage	$I_L=5mA$		-0.9		mV/°C

M5278LXX, M5278LXXM

(5V, 5.6V, 8V, 9V, 10V, 12V, 15V) 3-TERMINAL FIXED POSITIVE OUTPUT VOLTAGE REGULATOR (WITH FOLD-BACK PROTECTION CIRCUIT)

M5278L09 ($V_i=16V, I_L=40mA, T_a=25^\circ C, C_i=0.33\mu F, C_o=0.1\mu F$, unless otherwise noted)

Symbol	Parameter	Test conditions	Limits			Unit
			Min	Typ	Max	
V_O	Output voltage		8.55	9.0	9.45	V
R_{reg-in}	Input regulation	$12V \leq V_i \leq 24V$		60	225	mV
		$13V \leq V_i \leq 24V$		40	170	
R_{reg-L}	Load regulation	$1mA \leq I_L \leq 100mA$		10	90	mV
		$1mA \leq I_L \leq 40mA$		5	40	
V_O	Output voltage	$12V \leq V_i \leq 24V, 1mA \leq I_L \leq 40mA$	8.46	9.0	9.54	V
		$V_i=16V, 1mA \leq I_L \leq 70mA$	8.46	9.0	9.54	
I_B	Bias current	$I_L=0$		4.8	6.7	mA
ΔI_B	Bias current differential	$13V \leq V_i \leq 24V, I_L=40mA$		0.1	1.5	mA
		$V_i=16V, 1mA \leq I_L \leq 40mA$			0.2	
V_{NO}	Output noise voltage	BW: 10Hz~100kHz		90		μV_{rms}
RR	Ripple rejection ratio	$f=120Hz, V_{in}=0dBm$		60		dB
V_i-V_O	Minimum input-output voltage difference			2.0		V
I_{LP}	Peak load current			150		mA
I_{OS}	Output short circuit sustain current			12.5		mA
TC_{V_O}	Temperature coefficient of output voltage	$I_L=5mA$		-0.65		mV/°C

M5278L10 ($V_i=17V, I_L=40mA, T_a=25^\circ C, C_i=0.33\mu F, C_o=0.1\mu F$, unless otherwise noted)

Symbol	Parameter	Test conditions	Limits			Unit
			Min	Typ	Max	
V_O	Output voltage		9.5	10.0	10.5	V
R_{reg-in}	Input regulation	$12.5V \leq V_i \leq 25V$		70	230	mV
		$13V \leq V_i \leq 25V$		50	170	
R_{reg-L}	Load regulation	$1mA \leq I_L \leq 100mA$		10	90	mV
		$1mA \leq I_L \leq 40mA$		5	45	
V_O	Output voltage	$12.5V \leq V_i \leq 25V, 1mA \leq I_L \leq 40mA$	9.4	10.0	10.6	V
		$V_i=17V, 1mA \leq I_L \leq 70mA$	9.4	10.0	10.6	
I_B	Bias current	$I_L=0$		4.8	6.7	mA
ΔI_B	Bias current differential	$13V \leq V_i \leq 25V, I_L=40mA$		0.1	1.5	mA
		$V_i=17V, 1mA \leq I_L \leq 40mA$			0.2	
V_{NO}	Output noise voltage	BW: 10Hz~100kHz		100		μV_{rms}
RR	Ripple rejection ratio	$f=120Hz, V_{in}=0dBm$	52	59		dB
V_i-V_O	Minimum input-output voltage difference			2.0		V
I_{LP}	Peak load current			130		mA
I_{OS}	Output short circuit sustain current			12.5		mA
TC_{V_O}	Temperature coefficient of output voltage	$I_L=5mA$		-0.9		mV/°C

MITSUBISHI <LINEAR ICs>
M5278LXX, M5278LXXM

**(5V, 5.6V, 8V, 9V, 10V, 12V, 15V) 3-TERMINAL FIXED POSITIVE
OUTPUT VOLTAGE REGULATOR (WITH FOLD-BACK PROTECTION CIRCUIT)**

M5278L12 ($V_I=19V$, $I_L=40mA$, $T_a=25^\circ C$, $C_I=0.33\mu F$, $C_O=0.1\mu F$, unless otherwise noted)

Symbol	Parameter	Test conditions	Limits			Unit
			Min	Typ	Max	
V_O	Output voltage		11.4	12.0	12.6	V
R_{eg-in}	Input regulation	$14.5V \leq V_I \leq 27V$		70	250	mV
		$16V \leq V_I \leq 27V$		50	200	
R_{eg-L}	Load regulation	$1mA \leq I_L \leq 100mA$		10	100	mV
		$1mA \leq I_L \leq 40mA$		5	50	
V_O	Output voltage	$14.5V \leq V_I \leq 27V$, $1mA \leq I_L \leq 40mA$	11.3	12.0	12.7	V
		$V_I=19V$, $1mA \leq I_L \leq 70mA$	11.3	12.0	12.7	
I_B	Bias current	$I_L=0$		4.8	6.7	mA
ΔI_B	Bias current differential	$16V \leq V_I \leq 27V$, $I_L=40mA$		0.1	1.5	mA
		$V_I=19V$, $1mA \leq I_L \leq 40mA$			0.2	
V_{NO}	Output noise voltage	BW: 10Hz~100kHz		110		μV_{rms}
RR	Ripple rejection ratio	$f=120Hz$, $V_{in}=0dBm$	50	56		dB
$V_I - V_O$	Minimum input-output voltage difference			2.0		V
I_{LP}	Peak load current			150		mA
I_{OS}	Output short circuit sustain current			12.5		mA
TC_{VO}	Temperature coefficient of output voltage	$I_L=5mA$		-1.0		mV/ $^\circ C$

M5278L15 ($V_I=23V$, $I_L=40mA$, $T_a=25^\circ C$, $C_I=0.33\mu F$, $C_O=0.1\mu F$, unless otherwise noted)

Symbol	Parameter	Test conditions	Limits			Unit
			Min	Typ	Max	
V_O	Output voltage		14.25	15.0	15.75	V
R_{eg-in}	Input regulation	$17.5V \leq V_I \leq 30V$		80	300	mV
		$20V \leq V_I \leq 30V$		60	250	
R_{eg-L}	Load regulation	$1mA \leq I_L \leq 100mA$		10	150	mV
		$1mA \leq I_L \leq 40mA$		5	75	
V_O	Output voltage	$17.5V \leq V_I \leq 30V$, $1mA \leq I_L \leq 40mA$	14.1	15.0	15.9	V
		$V_I=23V$, $1mA \leq I_L \leq 70mA$	14.1	15.0	15.9	
I_B	Bias current	$I_L=0$		4.8	6.7	mA
ΔI_B	Bias current differential	$23V \leq V_I \leq 30V$, $I_L=40mA$		0.1	1.5	mA
		$V_I=23V$, $1mA \leq I_L \leq 40mA$			0.2	
V_{NO}	Output noise voltage	BW: 10Hz~100kHz		140		μV_{rms}
RR	Ripple rejection ratio	$f=120Hz$, $V_{in}=0dBm$	40	45		dB
$V_I - V_O$	Minimum input-output voltage difference			2.0		V
I_{LP}	Peak load current			150		mA
I_{OS}	Output short circuit sustain current			12.5		mA
TC_{VO}	Temperature coefficient of output voltage	$I_L=5mA$		-0.9		mV/ $^\circ C$

**(5V, 5.6V, 8V, 9V, 10V, 12V, 15V) 3-TERMINAL FIXED POSITIVE
 OUTPUT VOLTAGE REGULATOR (WITH FOLD-BACK PROTECTION CIRCUIT)**

TYPICAL CHARACTERISTICS

THERMAL DERATING (MAXIMUM RATING)

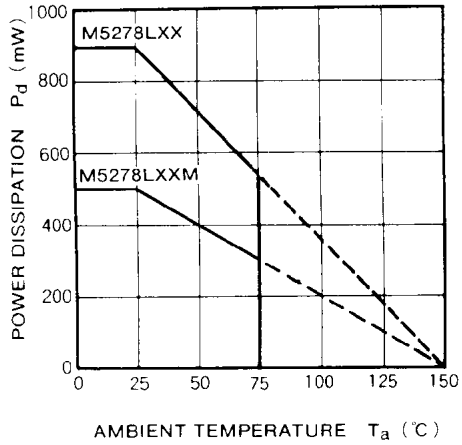

BIAS CURRENT VS. INPUT VOLTAGE

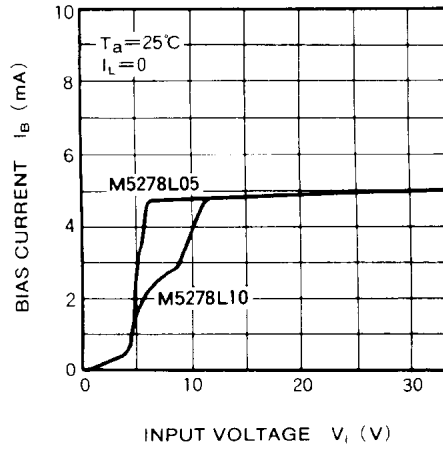

BIAS CURRENT VS. INPUT VOLTAGE

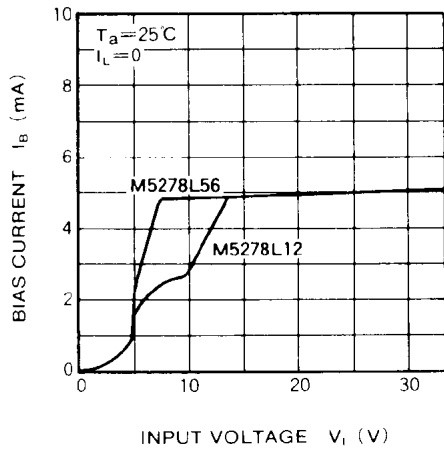

OUTPUT VOLTAGE VS. INPUT VOLTAGE

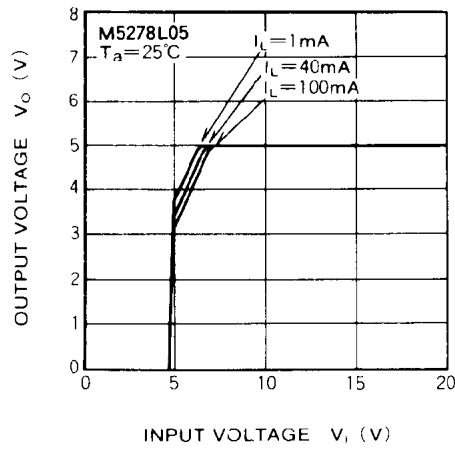

OUTPUT VOLTAGE VS. INPUT VOLTAGE

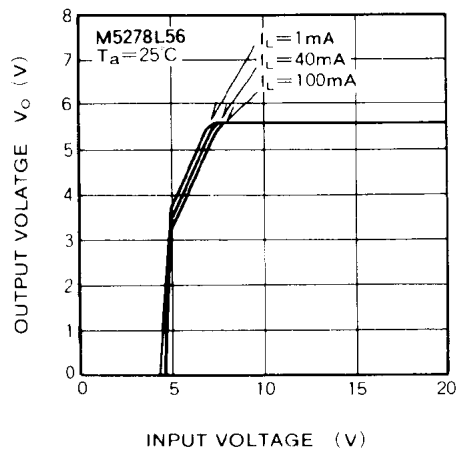

OUTPUT VOLTAGE VS. INPUT VOLTAGE

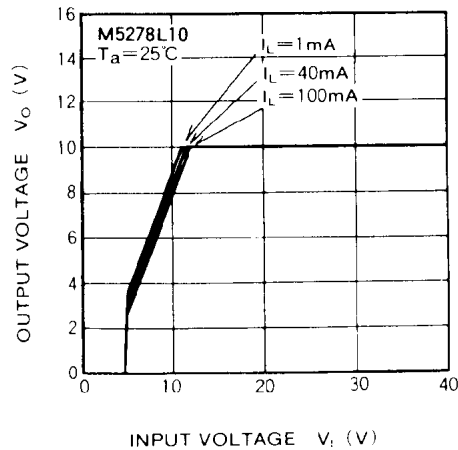

M5278LXX, M5278LXXM

(5V, 5.6V, 8V, 9V, 10V, 12V, 15V) 3-TERMINAL FIXED POSITIVE OUTPUT VOLTAGE REGULATOR (WITH FOLD-BACK PROTECTION CIRCUIT)

OUTPUT VOLTAGE VS. INPUT VOLTAGE

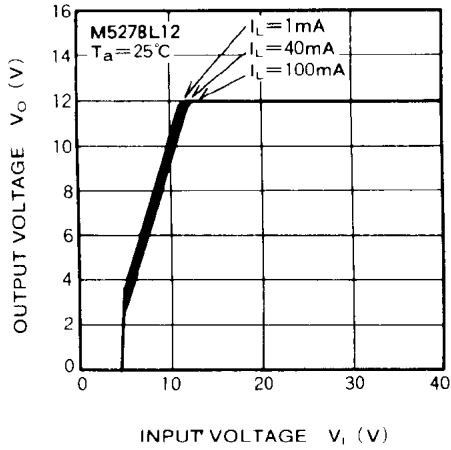

OUTPUT VOLTAGE VS. LOAD CURRENT

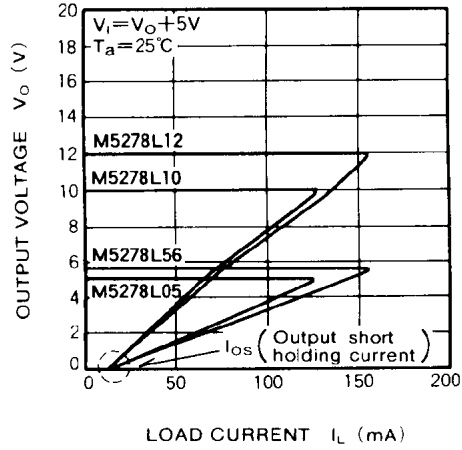

BIAS CURRENT VS. AMBIENT TEMPERATURE

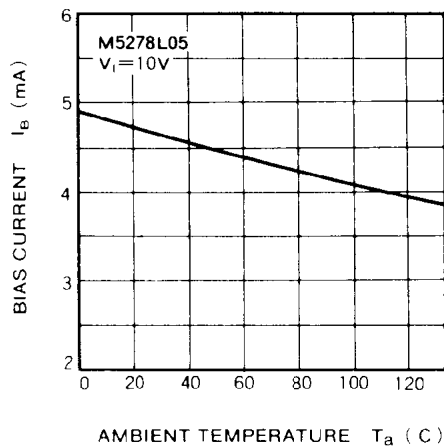

OUTPUT VOLTAGE VS. AMBIENT TEMPERATURE

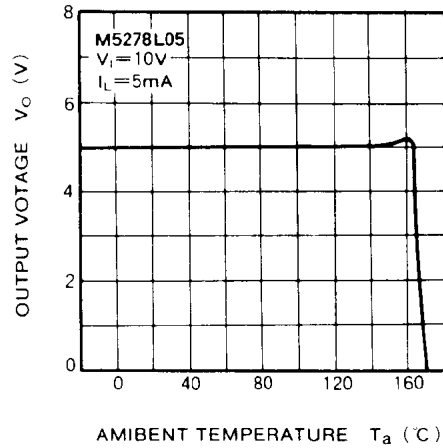

RIPPLE REJECTION VS. FREQUENCY

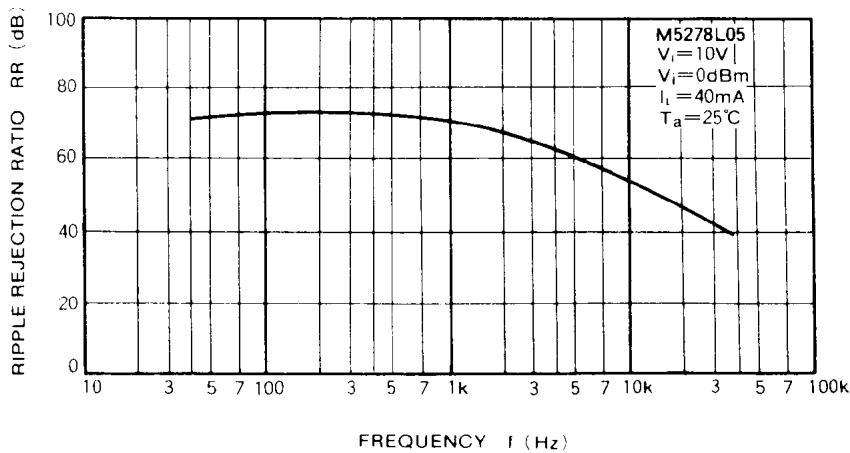

M5278LXX, M5278LXXM

(5V, 5.6V, 8V, 9V, 10V, 12V, 15V) 3-TERMINAL FIXED POSITIVE OUTPUT VOLTAGE REGULATOR (WITH FOLD-BACK PROTECTION CIRCUIT)

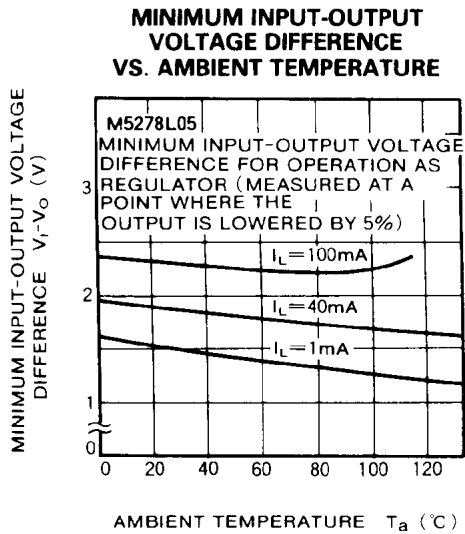

FOLD-BACK PROTECTION CIRCUIT

The M5278L series has been designed to be complete with three-pin, 78L type regulators manufactured by other companies for applications with loading currents in the 100mA class. They additionally have an internalized fold-back protection circuit for protection against shorted loads.

Other 78L units do have an internalized protection circuit known as a drooping type circuit that are rather simple, merely limiting maximum loading current. When large current begins to flow in these units due to a short circuit, abnormal temperatures are generated leading to breakdown and effective setting reliability.

As shown in the diagram, the fold-back protection circuit employed in the M5278L decreases immediately excessive current caused by a short in the load. This not only improves set reliability but permits the elimination of such protection circuits as fuses in the protection circuit.

PRECAUTIONS FOR USE

The current-control circuit requires that, as an IC power supply, this device be operated within the fold-back operating range shown in the accompanying chart.

OUTPUT VOLTAGE VS. LOAD CURRENT

