

TRIPLE DIFFUSED PLANER TYPE
HIGH VOLTAGE, HIGH SPEED SWITCHING

Features

- High voltage, High speed switching
- Low saturation voltage
- High reliability

Applications

- Switching regulators
- DC-DC convertor
- Solid state relay
- General purpose power amplifiers

Outline Drawings

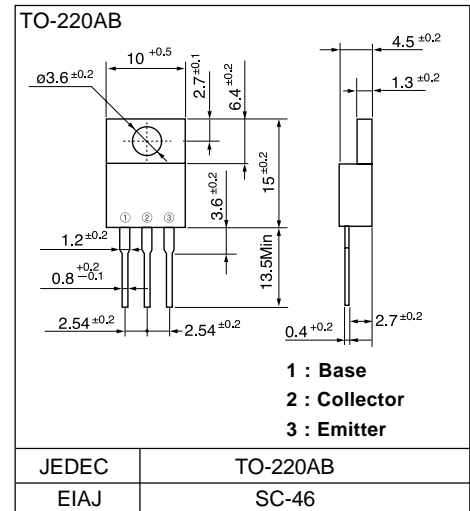

Maximum ratings and characteristics

Absolute maximum ratings ($T_c = 25^\circ\text{C}$ unless otherwise specified)

Item	Symbol	Ratings	Unit
Collector-Base voltage	V_{CB0}	450	V
Collector-Emitter voltage	V_{CE0}	400	V
Emitter-Base voltage	V_{EB0}	10	V
Collector current	I_C	7	A
Base current	I_B	2	A
Collector power dissipation	P_C	40	W
Operating junction temperature	T_j	+150	$^\circ\text{C}$
Storage temperature	T_{stg}	-55 to +150	$^\circ\text{C}$

Electrical characteristics ($T_c = 25^\circ\text{C}$ unless otherwise specified)

Item	Symbol	Test Conditions	Min.	Typ.	Max.	Units
Collector-Base voltage	V_{CB0}	$I_{CBO} = 1\text{mA}$	450			V
Collector-Emitter voltage	V_{CE0}	$I_{CEO} = 0.2\text{A}$	400			V
Emitter-Base voltage	V_{EB0}	$I_{EBO} = 1\text{mA}$	10	-		V
Collector-Base leakage current	I_{CBO}	$V_{CB0} = 450\text{V}$		-	0.1	mA
Emitter-Base leakage current	I_{EBO}	$V_{EB0} = 10\text{V}$		-	0.1	mA
D.C. current gain	h_{FE}	$I_C = 4\text{A}$, $V_{CE} = 5\text{V}$	10			
Collector-Emitter saturation voltage	$V_{CE(Sat)}$	$I_C = 4\text{A}$, $I_B = 800\text{mA}$			0.8	V
Base-Emitter saturation voltage	$V_{BE(Sat)}$				1.2	V
*1	t_{on}	$I_C = 5\text{A}$, $I_{B1} = 1\text{A}$			1.0	μs
Switching time	t_{stg}	$I_{B2} = -2\text{A}$, $R_L = 30\ \text{ohm}$			2.5	μs
	t_f	$P_w = 20\ \mu\text{s}$ Duty= $<2\%$			0.5	μs

Thermal characteristics

Item	Symbol	Test Conditions	Min.	Typ.	Max.	Units
Thermal resistance	$R_{th(j-c)}$	Junction to case			3.0	$^\circ\text{C/W}$

Characteristics

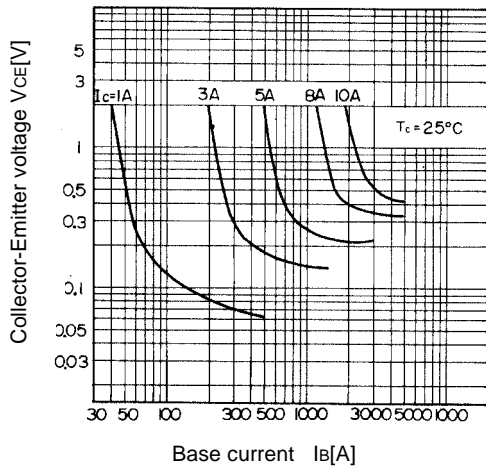

Collector Output Characteristics

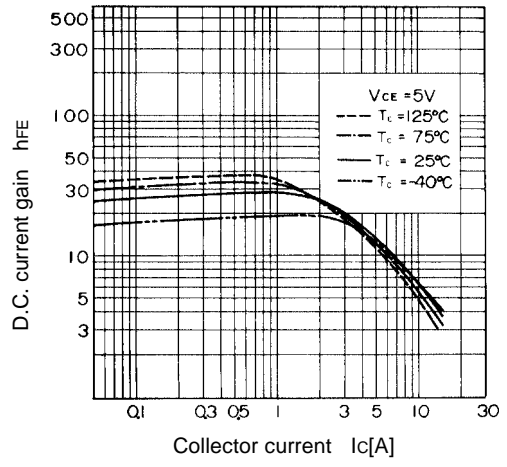

DC Current Gain

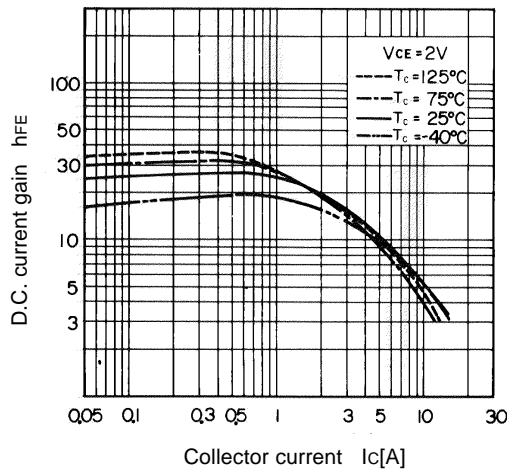

DC Current Gain

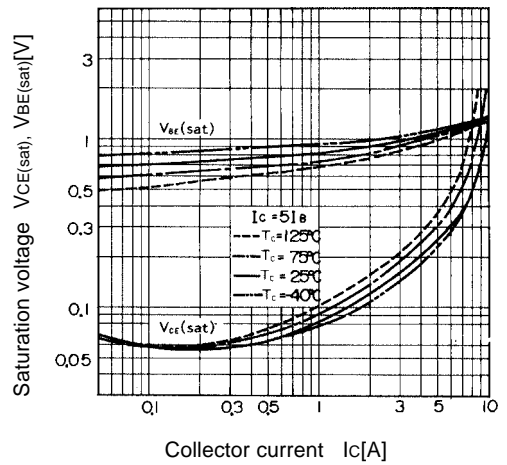

Base and Collector Saturation Voltage

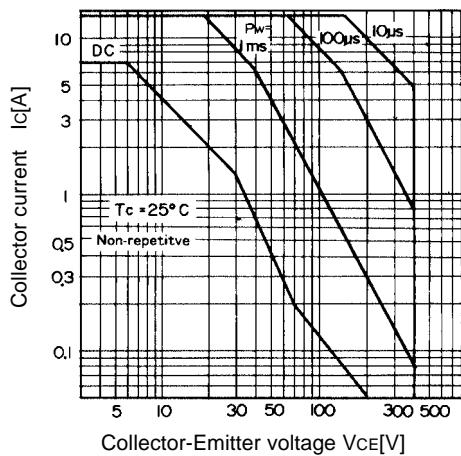

Safe Operating Area

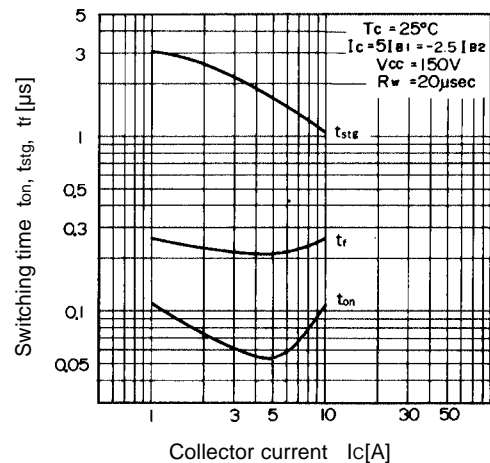

Switching Time