

T-74-05-01

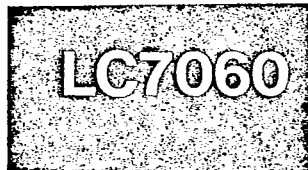

3025B

CMOS LSI

Graphic Equalizer Controller

©:6358

Use

- Controller of graphic equalizer electronic volume controller LSI LC7520, 7522/LCD driver LC7560/FL driver LC7565.

Functions

- 7 bands, 2dB/step, ±10dB (±12dB) variable [(): LC7522, 7565-combined use]
- Max. 8 memories (User option 5 modes, Maker option 3 modes) + Last channel memory.
- Possible to control function switch (LC7820) and electronic volume controller.
- 2 control lines for graphic equalizer electronic volume controller and display driver LSI.
- Buzzer sound is generated when a key is operated.
- On-chip remote control reception program.

Features

- Any combination of graphic equalizer electronic volume controller LSI LC7520, 7522 and display driver LSI LC7560, 7565 may be used. (Port-selectable)
- FLAT function to permit the FLAT mode to be entered with one touch.
- REVERSE function to permit the frequency characteristic to be reversed with respect to 0dB with one touch.
- Tuner band select and SCAN output.
- MUTE and MUTE output.
- Backup operation available.

Absolute Maximum Ratings/ $T_a = 25^\circ\text{C}$, $V_{SS} = 0\text{V}$

($V_{DD} = 5\text{V} \pm 10\%$ unless otherwise specified)

			unit	
Maximum supply voltage	V_{DD} max	-0.3 to +7.0	V	
Input voltage	V_{IN}	-0.3 to $V_{DD}+0.3$	V	Note 1
Output voltage	V_{OUT}	-0.3 to $V_{DD}+0.3$	V	
Peak output current	I_{O1}	One pin of all output ports except OSC2	-2.0 to +2.0	mA
	I_{O2}	All pins of all output ports except OSC2	-26 to +26	mA
Allowable power dissipation	P_d max	$T_a = -30$ to $+70^\circ\text{C}$	350	mW
Operating temperature	T_{opg}		-30 to +70	$^\circ\text{C}$
Storage temperature	T_{stg}		-55 to +125	$^\circ\text{C}$

Note 1: For OSC1 pin, up to oscillation amplitude generated when internally oscillated under the allowable oscillation conditions in Fig. 2 is allowable.



Case Outline 3025B-D42SIC
(unit: mm)

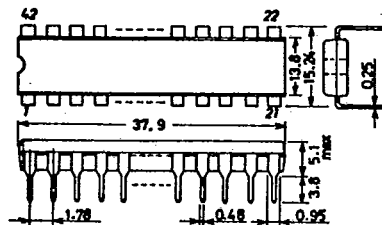

SANYO:DIP42S

LC7060

T-74-05-01

Allowable Operating Conditions/ $T_a = -30$ to $+70^\circ\text{C}$, $V_{SS} = 0\text{V}$			min	typ	max	unit
Operating supply voltage	$V_{DD}(1)$		4.5	5.0	5.5	V
Power-down supply voltage	$V_{DD}(2)$	$\text{HOLD} = V_{IL}(3)$	2.0		5.5	V
Input "H"-level voltage	$V_{IH}(1)$	Input pins other than $\overline{\text{INT}}$, RES, HOLD, OSC1	$0.7V_{DD}$		V_{DD}	V
Input "L"-level voltage	$V_{IH}(2)$	$\overline{\text{INT}}$, RES, HOLD, OSC1 pins	$0.75V_{DD}$		V_{DD}	V
	$V_{IL}(1)$	Input pins other than $\overline{\text{INT}}$, RES, HOLD, OSC1	V_{SS}		$0.3V_{DD}$	V
	$V_{IL}(2)$	$\overline{\text{INT}}$, RES, OSC1 pins	V_{SS}		$0.25V_{DD}$	V
	$V_{IL}(3)$	$V_{DD} = 2$ to 5.5V , HOLD pin	V_{SS}		$0.3V_{DD}$ -0.3	V
Operating clock frequency	$V_{IL}(4)$	TEST pin	V_{SS}		$0.3V_{DD}$	V
	f_{extosc}	External clock input mode, See Fig. 1.	380		420	kHz
"H"-level clock pulse width	$t_{W\phi H}$	External clock input mode See Fig. 1.	0.5			μs
"L"-level clock pulse width	$t_{W\phi L}$	External clock input mode, See Fig. 1.	0.5			μs
Clock input rise time	t_{oscR}	External clock input mode See Fig. 1.			0.2	μs
Clock input fall time	t_{oscF}	External clock input mode, See Fig. 1.			0.2	μs
External capacitance for ceramic OSC	C_1	See Fig. 2.			$100 \pm 10\%$	pF
	C_2	See Fig. 2.			$100 \pm 10\%$	pF
External resistance for ceramic OSC	R_1	See Fig. 2.			$1000 \pm 5\%$	$\text{k}\Omega$
	R_2	See Fig. 2.	KBR400B		$4.7 \pm 5\%$	$\text{k}\Omega$
			CSB400P		$2.2 \pm 5\%$	$\text{k}\Omega$

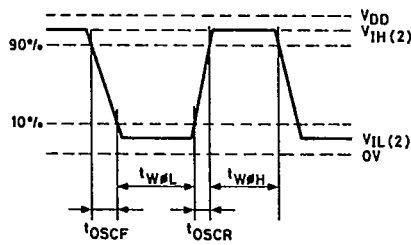
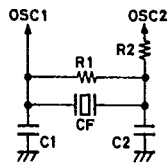

Fig. 1 OSC1 Pin Input Waveform



CF: Ceramic resonator
CSB400P (Murata)
KBR400B (Kyocera)

Fig. 2 Recommended OSC Circuit for Ceramic OSC

Electrical Characteristics/ $T_a = -30$ to $+70^\circ\text{C}$, $V_{DD} = 5\text{V} \pm 10\%$, $V_{SS} = 0\text{V}$			min	typ	max	unit
Input "H"-level current	I_{IH}	All input pins, $V_{IN} = V_{DD}$			1	μA
Input "L"-level current	I_{IL}	All input pins, $V_{IN} = V_{SS}$	-1			μA
Output "H"-level voltage	$V_{OH}(1)$	Output pins other than OSC2, $I_{OH} = -1\text{mA}$	$V_{DD} - 2$			V
	$V_{OH}(2)$	Output pins other than OSC2, $I_{OH} = -100\mu\text{A}$	$V_{DD} - 0.5$			V
Output "L"-level voltage	V_{OL}	Output pins other than OSC2, $I_{OL} = 1\text{mA}$			0.4	V
Output OFF leakage current	$I_{OFF}(1)$	Output pins other than OSC2, $V_{OH} = V_{DD}$			1	μA
	$I_{OFF}(2)$	Output pins other than OSC2, $V_{OL} = V_{SS}$	-1			μA
Clock OSC frequency for ceramic OSC	f_{XOSC}	At recommended OSC circuit for ceramic OSC in Fig. 2	384	400	417	kHz

Continued on next page.

LC7060

T-74-05-01

Continued from preceding page.

			min	typ	max	unit
Current dissipation	I_{DD}	Ceramic OSC mode, output pin open, input pin, $V_{IN} = V_{DD}$		0.5	1.0	mA
Input capacitance	C_{IN}	$f = 1\text{MHz}$		5		pF
Output capacitance	C_{OUT}	$f = 1\text{MHz}$, output high impedance		10		pF
Input/output capacitance	C_{IO}	$f = 1\text{MHz}$, output high impedance		10		pF

Initial Reset Timing

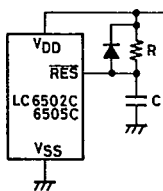
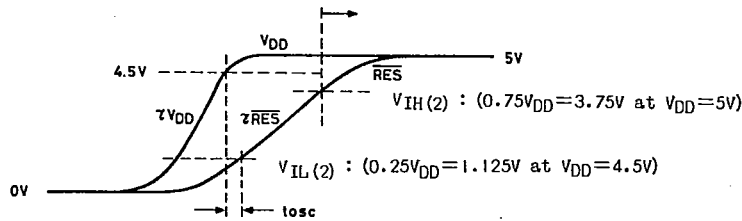

τ_{VDD} : Power supply rise time constant
 τ_{RES} : RES pin rise time constant
 Fix C, R so that $\tau_{VDD} \leq \tau_{RES}$, $t_{OSC} \geq 10\text{msec}$ are yielded.
 (t_{OSC} : OSC stabilizing time)

Pin Assignment

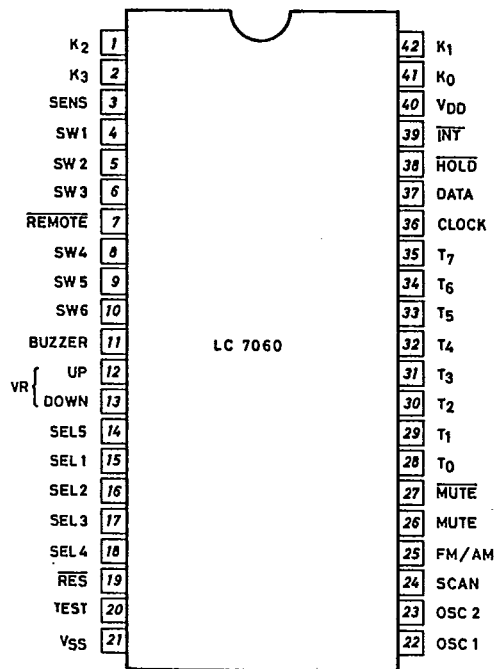

LC7060

T-74-05-01

Pin Description

Pin Name	Pin No.	Input/Output	Description												
K ₀ to K ₃	41, 42 1, 2	I	Key matrix return signal input pin. K ₀ to K ₃ and T ₀ to T ₇ form key matrix.												
SENS	3	I	Backup voltage sense pin. After reset, backup returns at "H"; initial power is ON at "L".												
SW1	4	I	Pin for selecting number of user memories, maker option memories. Set to "H" for 8 memories. <table border="1" style="float: right; margin-left: 20px;"> <tr> <td>"L"</td> <td>User 2, maker 3</td> </tr> <tr> <td>"H"</td> <td>User 5, maker 0</td> </tr> </table>	"L"	User 2, maker 3	"H"	User 5, maker 0								
"L"	User 2, maker 3														
"H"	User 5, maker 0														
SW2	5	I	Pin for selecting graphic equalizer electronic volume control LSI LC7520, LC7522 <table border="1" style="float: right; margin-left: 20px;"> <tr> <td>"L"</td> <td>LC7520</td> </tr> <tr> <td>"H"</td> <td>LC7522</td> </tr> </table>	"L"	LC7520	"H"	LC7522								
"L"	LC7520														
"H"	LC7522														
SW3	6	I	Pin for selecting display IC LC7565, LC7560 <table border="1" style="float: right; margin-left: 20px;"> <tr> <td>"L"</td> <td>LC7565</td> </tr> <tr> <td>"H"</td> <td>LC7560</td> </tr> </table>	"L"	LC7565	"H"	LC7560								
"L"	LC7565														
"H"	LC7560														
REMOTE	7	I	Remote control signal input pin. Set to "H" when not used.												
SW4	8	I	<table border="1" style="width: 100%;"> <tr> <td colspan="2" style="text-align: center;">When SW5 = "L"</td> <td colspan="2" style="text-align: center;">When SW5 = "H"</td> </tr> <tr> <td style="width: 25%;">"L"</td> <td style="width: 75%;">GEO display is provided for 5 seconds with G/S key.</td> <td style="width: 25%;">"L"</td> <td style="width: 75%;">Impossible to change display with other than G/S key.</td> </tr> <tr> <td>"H"</td> <td>Display is changed with G/S key. Then, this display mode is fixed.</td> <td>"H"</td> <td>Same as for SW5 = "L"</td> </tr> </table>	When SW5 = "L"		When SW5 = "H"		"L"	GEO display is provided for 5 seconds with G/S key.	"L"	Impossible to change display with other than G/S key.	"H"	Display is changed with G/S key. Then, this display mode is fixed.	"H"	Same as for SW5 = "L"
When SW5 = "L"		When SW5 = "H"													
"L"	GEO display is provided for 5 seconds with G/S key.	"L"	Impossible to change display with other than G/S key.												
"H"	Display is changed with G/S key. Then, this display mode is fixed.	"H"	Same as for SW5 = "L"												
SW5	9	I	Pin for selecting MEMORY display flashing ON/OFF, number of memories, function spec. Possible to control function SW IC LC7820 at "H". For key matrix, port assignment, see spec. for SW5 = "H". <table border="1" style="float: right; margin-left: 20px;"> <tr> <td>"L"</td> <td>MEMORY display flashing, number of memories: 5</td> </tr> <tr> <td>"H"</td> <td>MEMORY display lighted, number of memories: 8, LC7820 use</td> </tr> </table>	"L"	MEMORY display flashing, number of memories: 5	"H"	MEMORY display lighted, number of memories: 8, LC7820 use								
"L"	MEMORY display flashing, number of memories: 5														
"H"	MEMORY display lighted, number of memories: 8, LC7820 use														
SW6	10	I	Select pin for using display IC as spectrum analyzing display use only. <table border="1" style="float: right; margin-left: 20px;"> <tr> <td>"L"</td> <td>Normal graphic equalizer controller</td> </tr> <tr> <td>"H"</td> <td>Only providing spectrum analyzing display at power-ON mode</td> </tr> </table>	"L"	Normal graphic equalizer controller	"H"	Only providing spectrum analyzing display at power-ON mode								
"L"	Normal graphic equalizer controller														
"H"	Only providing spectrum analyzing display at power-ON mode														
BUZZER	11	O	Piezo-electric buzzer drive output pin. For frequency, see detailed description.												
VR UP/DOWN	12/13	O	Electronic volume controller LSI control output pin. Pushing UP/DOWN key delivers "H" pulse at corresponding output port for 0.1sec.												
SEL 1 to 4	15, 16 17, 18	O	Function select output pin. Pushing key delivers "H" pulse at corresponding port for 0.3 sec.												
SEL5	14	O	Function select output pin. Pushing SEL5 key inverts "H" output (cyclic). Set to "L" when SEL1 to 4 are selected.												
RES	19	I	Reset pin												
TEST	20	I	LSI test pin. In normal operation, set to "L".												
VSS	21	-	Power supply pin. Connected to GND.												

Continued on next page.

Continued from preceding page.

Pin Name	Pin No.	Input/Output	Description																																													
OSC1	22	I	<p>Pin for supplying clock externally (400kHz). For internal clock mode, connected with OSC2 pin as shown below.</p> <p>R2: See Electrical Characteristics.</p>																																													
OSC2	23	O	Pin for externally connecting resonance circuit for internal clock mode.																																													
SCAN	24	O	Tuner scan output pin. Pushing key delivers "H" pulse for 0.3sec.																																													
FM/AM	25	O	Tuner band select output pin. Pushing key delivers "H" pulse for 0.3sec.																																													
MUTE	26	O	Muting output pin. Muting ON: "H", muting OFF: "L"																																													
$\overline{\text{MUTE}}$	27	O	Muting output pin. Muting ON: "L", muting OFF: "H"																																													
T ₀ to T ₇	28 to 35	O	<p>Key digit output pin. T₀ to T₇ and K₀ to K₃ form key matrix.</p> <table border="1" style="margin-left: auto; margin-right: auto;"> <tr> <td>K₀</td> <td>f₁</td> <td>f₅</td> <td>M1</td> <td>M5</td> <td>SEL1</td> <td>SEL5</td> <td>GEQ UP</td> <td>P. HLD SPEANA</td> </tr> <tr> <td>K₁</td> <td>f₂</td> <td>f₆</td> <td>M2</td> <td>PLAT</td> <td>SEL2</td> <td>FM/AM</td> <td>GEQ DOWN</td> <td>P. HLD TOTAL</td> </tr> <tr> <td>K₂</td> <td>f₃</td> <td>f₇</td> <td>M3</td> <td>MUTE</td> <td>SEL3</td> <td>—</td> <td>VR UP</td> <td>REVERSE</td> </tr> <tr> <td>K₃</td> <td>f₄</td> <td>MEMO</td> <td>M4</td> <td>G/S</td> <td>SEL4</td> <td>SCAN</td> <td>VR DOWN</td> <td>DIMMER</td> </tr> <tr> <td></td> <td>T₀</td> <td>T₁</td> <td>T₂</td> <td>T₃</td> <td>T₄</td> <td>T₅</td> <td>T₆</td> <td>T₇</td> </tr> </table>	K ₀	f ₁	f ₅	M1	M5	SEL1	SEL5	GEQ UP	P. HLD SPEANA	K ₁	f ₂	f ₆	M2	PLAT	SEL2	FM/AM	GEQ DOWN	P. HLD TOTAL	K ₂	f ₃	f ₇	M3	MUTE	SEL3	—	VR UP	REVERSE	K ₃	f ₄	MEMO	M4	G/S	SEL4	SCAN	VR DOWN	DIMMER		T ₀	T ₁	T ₂	T ₃	T ₄	T ₅	T ₆	T ₇
K ₀	f ₁	f ₅	M1	M5	SEL1	SEL5	GEQ UP	P. HLD SPEANA																																								
K ₁	f ₂	f ₆	M2	PLAT	SEL2	FM/AM	GEQ DOWN	P. HLD TOTAL																																								
K ₂	f ₃	f ₇	M3	MUTE	SEL3	—	VR UP	REVERSE																																								
K ₃	f ₄	MEMO	M4	G/S	SEL4	SCAN	VR DOWN	DIMMER																																								
	T ₀	T ₁	T ₂	T ₃	T ₄	T ₅	T ₆	T ₇																																								
CLOCK	36	O	ECS clock output pin.																																													
DATA	37	O	ECS data output pin.																																													
$\overline{\text{HOLD}}$	38	I	Backup mode request pin. Timing is described later.																																													
INT	39	I	External interrupt request pin. In normal operation, set to "H".																																													
VDD	40	—	Power supply pin +5V																																													

LC7060

T-74-05-01

Key Description

- (1) f₁ to f₇ (band select key)
- Used to select band when changing setting in each band of graphic equalizer.
 - Selected band flashes at its setting point.
 - When this key is pushed, GEQ display mode is entered.
 - If no input is applied for 5 seconds after key-in operation, spectrum analyzing display mode is entered automatically.
- (2) GEQ UP/DOWN (graphic equalizer setting UP/DOWN key)
- After selecting band by use of f₁ to f₇, this key is used to cause band setting to go UP/DOWN (± 2 dB step).
 - Holding key pushed causes band setting to go UP/DOWN at 0.5sec./step rate. When upper/lower limit is reached, band setting stops going UP/DOWN.
 - If there is no band that flashes, no going UP/DOWN occurs.
 - If no input is applied for 5 seconds after releasing key, spectrum analyzing display mode is entered automatically.
- (3) MEMO (memory key)
- When storing GEQ setting, this key is used to cause memory enable mode.
 - [MEMORY] indicator flashes (0.5sec. ON, 0.5 sec. OFF) at memory enable mode.
 - When this key is pushed, GEQ display mode is entered. If no input is applied thereafter, spectrum analyzing display mode is entered 5 seconds later and [MEMORY] indicator also goes out.
 - If other key (except this key) is pushed within 5 seconds after key-in operation, memory enable mode is released and [MEMORY] indicator also goes out.
 - When SW5 = "H", [MEMORY] indicator does not flash, but remains lighted.
- (4) M1 to M5 (preset memory key)
- Used to call from/write into preset memory. Indicator corresponding to No. is lighted.
 - When pushed at [MEMORY]-ON mode, writing-into memory corresponding to No. specified is performed. (Note) When SW1 = "L", M3 to M5 are for maker option memories. Writing is inhibited.
 - When pushed at [MEMORY]-OFF mode, memory contents corresponding to No. specified are called.
 - When pushed, GEQ display mode is entered. Spectrum analyzing display mode is entered automatically 5 seconds thereafter.
- (5) FLAT (flat key)
- Used to make setting in each band flat with one touch (f₁ to f₇ = 0dB).
 - When SW3 = "L", FLAT indicator is lighted.
 - When pushed, GEQ display mode is entered. Spectrum analyzing display mode is entered automatically 5 seconds thereafter.
- (6) G/S (GEQ display/spectrum analyzing display mode select key)
- SW4 = "L", SW5 = "L"
 - When pushed, GEQ display mode is entered and remains held for 5 seconds. Spectrum analyzing display mode is entered automatically thereafter.
 - SW4 = "L", SW5 = "H"
 - This key only can be used to select GEQ display mode/spectrum analyzing display mode.
 - SW4 = "H"
 - When pushed, display mode is changed (GEQ display mode \leftrightarrow spectrum analyzing mode) and remains held until this key is pushed again.
 1. In case where spectrum analyzing display mode is entered after key-in operation (spectrum analyzing mode):
When other key is pushed, GEQ display mode is entered and spectrum analyzing display mode returns 5 seconds later (normal specification).
 2. In case where GEQ display mode is entered after key-in operation (graphic equalizer mode):
GEQ display mode remains held even when 5 seconds have elapsed after other key-in operation (no spectrum analyzing display mode is entered).
- (7) SEL1 to 4 (selector key)
- Function setting key
 - "H" pulse is delivered at output port corresponding to No. for 0.3 second.
 - Set to SEL1 when power is applied.
 - Muting signal is delivered at MUTE pin for 0.5 second when selection is made.

LC7060

T-74-05-01

- (8) SEL5 (selector key)
 - Function setting key
 - When pushed, output at SEL5 pin is inverted (cyclic).
 - Set to "L" when SEL1 to 4 are selected.
- (9) VR UP/DOWN (volume UP/DOWN key)
 - Electronic volume control key
 - When pushed, 0.1 second "H" pulse is delivered at corresponding output port.
 - When pushed continuously, this pulse is delivered every 0.5 second.
- (10) MUTE (muting key)
 - Muting ON/OFF key
 - Each time this key is pushed, output at MUTE, $\overline{\text{MUTE}}$ pin is inverted.
 - Indicator is lighted at muting ON mode.
- (11) FM/AM (band select key)
 - Tuner band select key
 - When pushed, FM/AM output pin is set to "H" for 0.3 second.
- (12) SCAN (scan key)
 - Tuner scan key
 - When pushed, "H" pulse is delivered at SCAN pin for 0.3 second.
- (13) P.HLD SPEANA/TOTAL (peak hold ON/OFF key)
 - Spectrum analyzing display, TOTAL display peak hold ON/OFF key.
 - Cyclic operation of peak hold ON/OFF (invalid at SW3 = "H").
 - SPEANA -----ON, TOTAL -----OFF at initial power ON mode.
- (14) REVERSE (reverse key)
 - Used to reverse setting of graphic equalizer with respect to 0dB.
 - When pushed, GEO display mode is entered and spectrum analyzing display mode returns automatically 5 seconds later.
- (15) DIMMER (dimmer key)
 - Dimmer ON/OFF key
 - Invalid at SW3 = "H"
 - DIMMER OFF at initial power ON mode.

(Note) Muting

Besides MUTE key, keys shown below can be used to deliver muting signal. (SW5 = "L")

- 1. M1 to M5, FLAT, REVERSE key 0.1 sec. Muting ON
- 2. SCAN key 0.3 sec. Muting ON
- 3. SEL1 to 5, FM/AM key 0.5 sec. Muting ON
- 4. Power ON mode 0.5 sec. Muting ON

* When the same key of SEL1 to 4 is pushed twice, muting ON mode occurs twice.
 When SW5 = "H", muting signal is delivered only when power is applied or key-in operation for function SW is performed.

LC7060

T-74-05-01

Other Specifications

(1) Specification for buzzer sound

- When f₁ to f₇, FLAT key is pushed, output with frequency shown below is delivered at BUZZER pin for 80msec.

f ₁	f ₂	f ₃	f ₄	f ₅	f ₆	f ₇	FLAT
441Hz	495Hz	556Hz	588Hz	662Hz	741Hz	833Hz	885Hz

- When other key is pushed, output with 885Hz is delivered for 80msec.

(2) Operation at initial power ON mode and backup return mode

Function	Initial power ON	Backup return
GEO setting	FLAT	LAST
MEMORY contents	FLAT	LAST
MEMORY No.	OFF	LAST
f ₁ to f ₇ select (FLASHING)	OFF	←
MEMORY	Impossible to use MEMORY	←
GEO/SPEANA display	GEO display for 5sec. and SPEANA display thereafter	←
MUTE/MUTE	ON for 0.5sec.	←
SEL1 to 5	SEL1	←
SPEANA P.HLD	ON	LAST
TOTAL P.HLD	OFF	LAST
DIMMER	OFF	LAST

(3) Specification depending on combination of IC's for graphic equalizer use

GEO electronic volume control IC	Display IC	Variable range	Peak hold	Dimmer	FLAT display
LC7520	LC7560	±10dB	Without	Without	Without
	LC7565	±10dB	With	With	With
LC7522	LC7560	±10dB	Without	Without	Without
	LC7565	±12dB	With	With	With

(4) Backup mode release timing

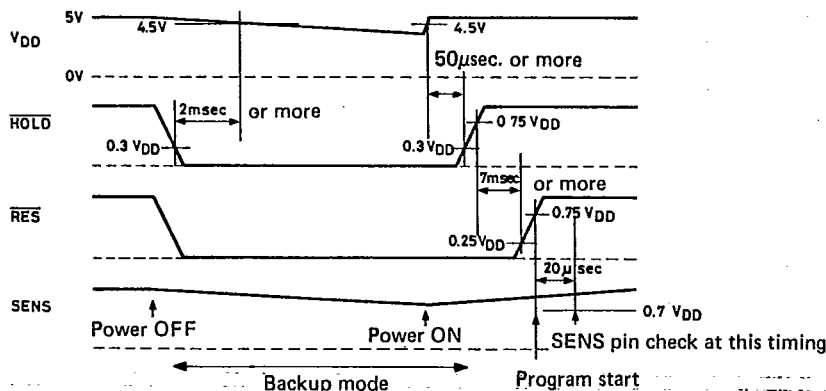

LC7060

T-74-05-01

(5) Segment assignment

1. In case where LC7560 is used (LCD):

8 x 11 segments

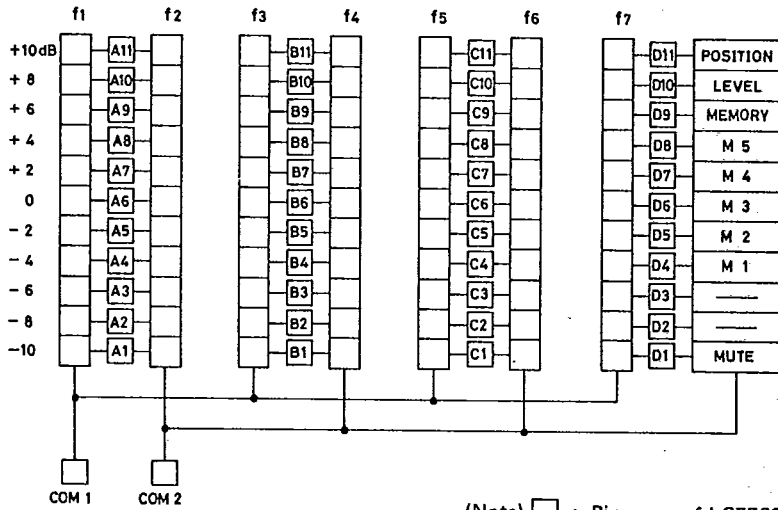

(Note) □ : Pin name of LC7560

2. In case where LC7565 is used (FL)

9 x 13 segments

	f1	f2	f3	f4	f5	f6	f7	TOTAL		
+12dB	←	←	←	←	←	←	←	24dB	POSITION	A13
+10	←	←	←	←	←	←	←	22	LEVEL	A12
+8	←	←	←	←	←	←	←	20	MEMORY	A11
+6	←	←	←	←	←	←	←	18	FLAT	A10
+4	←	←	←	←	←	←	←	16	M 5	A9
+2	←	←	←	←	←	←	←	14	M 4	A8
0	←	←	←	←	←	←	←	12	M 3	A7
-2	←	←	←	←	←	←	←	10	M 2	A6
-4	←	←	←	←	←	←	←	8	M 1	A5
-6	←	←	←	←	←	←	←	6	MUTE	A4
-8	←	←	←	←	←	←	←	4	—	A3
-10	←	←	←	←	←	←	←	2	—	A2
-12	←	←	←	←	←	←	←	0	Always ON	A1
	G1	G2	G3	G4	G5	G6	G7	G8	G9	

(Note) □ : Pin name of LC7565

- POSITION is lighted at GEQ display mode; and LEVEL is lighted at spectrum analyzing display mode.

LC7060

T-74-05-01

(6) Specifications for SW5 = "H"

When SW5 = "H", the pin assignment and key matrix become as shown below.

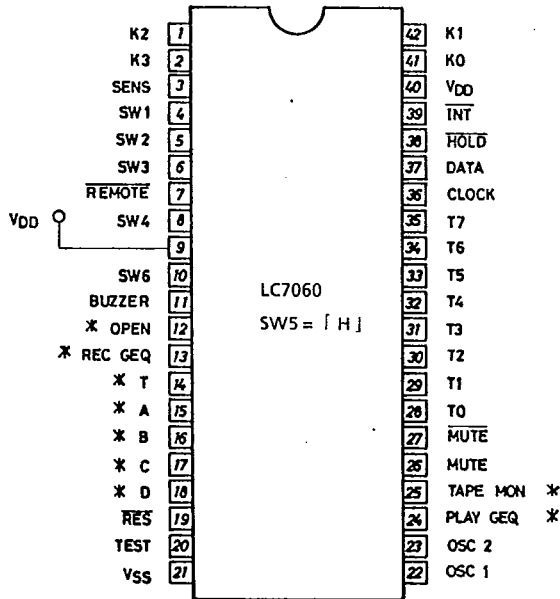

*: Pin name different from that when SW5 = "L"

Key Matrix

K0	f ₁	f ₅	M 1	M 5	* A	* T	GEQ UP	P. HOLD SPEANA
K1	f ₂	f ₆	M 2	FLAT	* B	* TAPE MON	GEQ DOWN	P. HOLD TOTAL
K2	f ₃	f ₇	M 3	REC GEQ	* C	* M 8	* M 6	REVERSE
K3	f ₄	MEMO	M 4	G/S	* D	* PLAY GEQ	* M 7	DIMMER
	T ₀	T ₁	T ₂	T ₃	T ₄	T ₅	T ₆	T ₇

Specifications for SW5 = "H" are different from those for SW5 = "L" in the following points.

1. Number of memories: 8 in all (user option 5 modes, maker option 3 mode) (SW1 = "H")
2. Possible to control function SW IC LC7820
3. VR UP/DOWN, SCAN, FM/AM functions are negated.

T-90-20

AUDIO-USE MOS IC CASE OUTLINES

- All of Sanyo audio-use MOS IC case outlines are illustrated below.
- All dimensions are in mm, and dimensions which are not followed by min. or max. are represented by typical values.
- No marking is indicated.

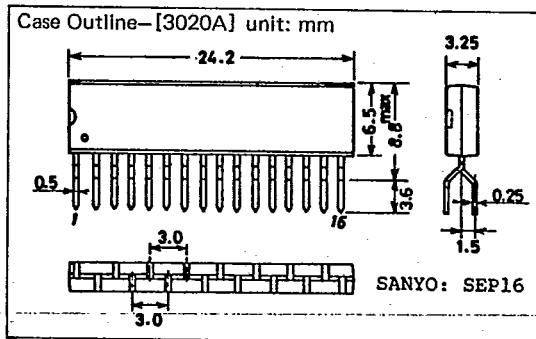
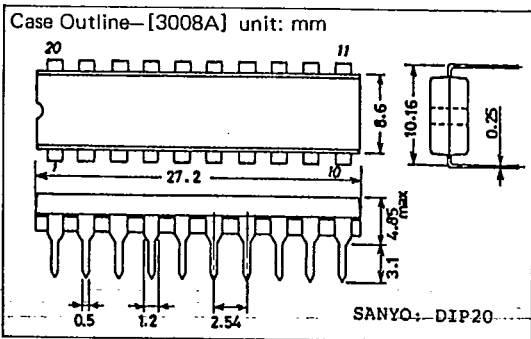
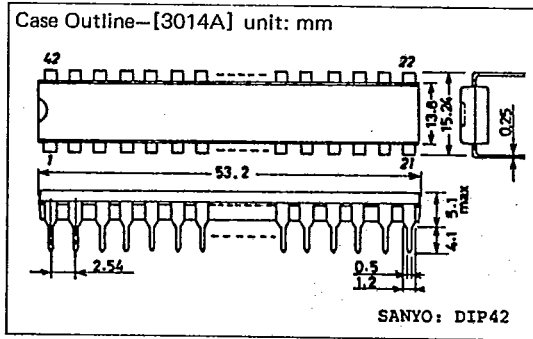
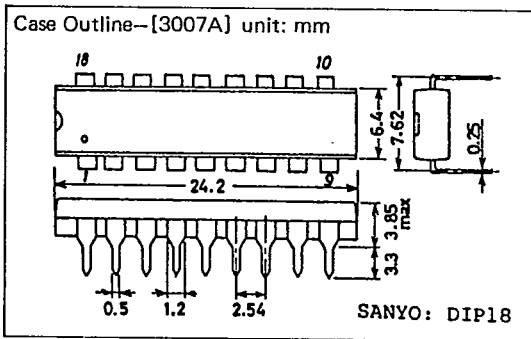
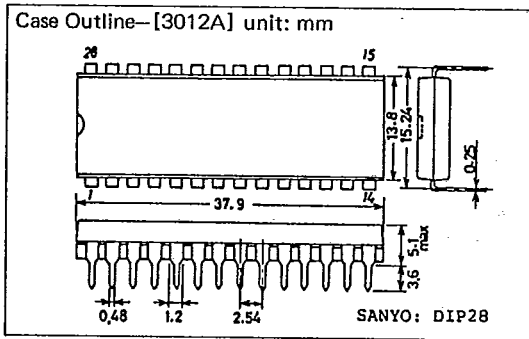
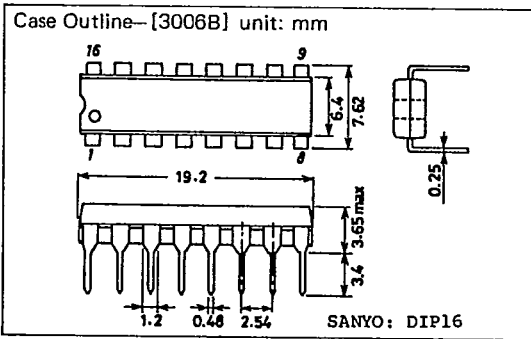
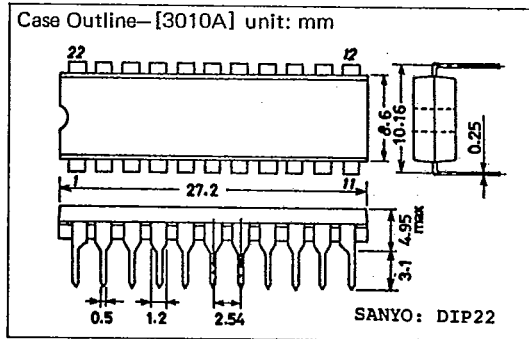
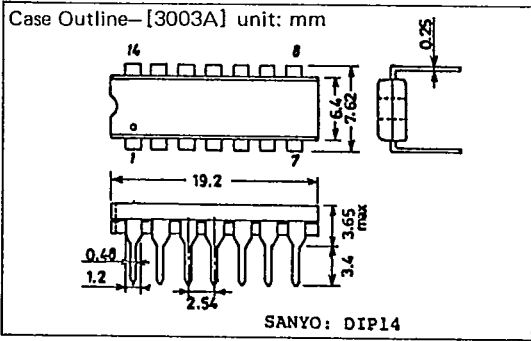

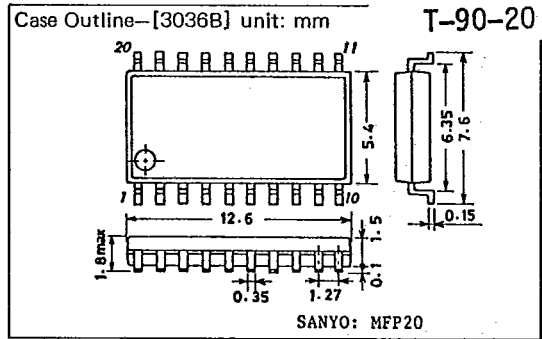
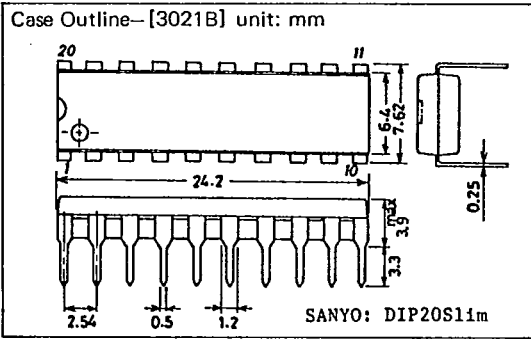

T-90-20

