

# 2SC1573, 2SC1573A, 2SC1573B

Silicon NPN triple diffusion planer type

For high breakdown voltage general amplification

For small TV video output

Complementary to 2SC1573 and 2SA879

## Features

- High collector to emitter voltage  $V_{CE0}$ .
- High transition frequency  $f_T$ .

## Absolute Maximum Ratings (Ta=25°C)

Parameter	Symbol	Rated	Unit
Collector to base voltage	2SC1573	250	V
	2SC1573A	300	
	2SC1573B	400	
Collector to emitter voltage	2SC1573	200	V
	2SC1573A	300	
	2SC1573B	400	
Emitter to base voltage	$V_{EBO}$	7	V
Peak collector current	$I_{CP}$	100	mA
Collector current	$I_C$	70	mA
Collector power dissipation	$P_C$	1	W
Junction temperature	$T_j$	150	°C
Storage temperature	$T_{stg}$	-55 ~ +150	°C

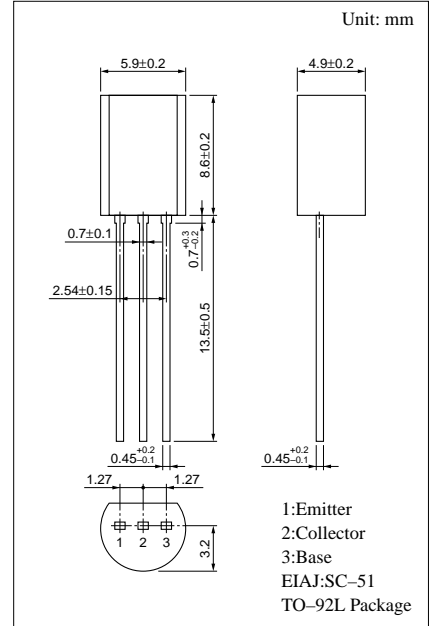

## Electrical Characteristics (Ta=25°C)

Parameter	Symbol	Conditions	min	typ	max	Unit
Collector cutoff current	$I_{CBO}$	$V_{CB} = 12V, I_E = 0$			2	$\mu A$
Collector to emitter voltage	2SC1573	$I_C = 100\mu A, I_B = 0$	200			V
	2SC1573A		300			
	2SC1573B		400			
Emitter to base voltage	2SC1573	$I_E = 1\mu A, I_C = 0$	5			V
	2SC1573A		7			
	2SC1573B					
Forward current transfer ratio	$h_{FE}^*$	$V_{CE} = 10V, I_C = 5mA$	30		220	
Collector to emitter saturation voltage	$V_{CE(sat)}$	$I_C = 50mA, I_B = 5mA$			1.2	V
Transition frequency	$f_T$	$V_{CB} = 10V, I_E = -10mA, f = 200MHz$	50	80		MHz
Collector output capacitance	2SC1573	$V_{CB} = 10V, I_E = 0, f = 1MHz$		5	10	pF
	2SC1573A					
	2SC1573B		4	8		

\* $h_{FE}$  Rank classification

Rank	P	Q	R
$h_{FE}$	30 ~ 100	60 ~ 150	100 ~ 220

\*2SC1573 for Ranks Q and R only

$P_C - T_a$

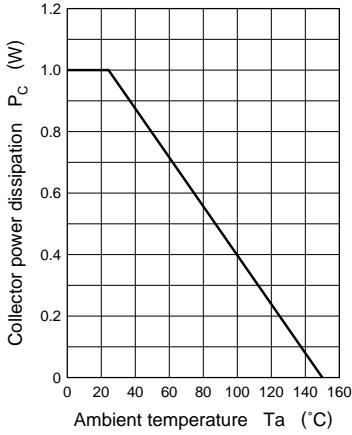

$I_C - V_{CE}$

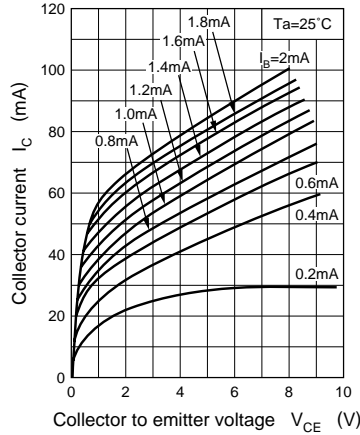

$I_C - V_{BE}$

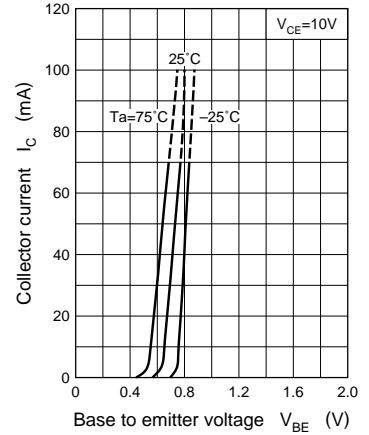

$I_C - I_B$

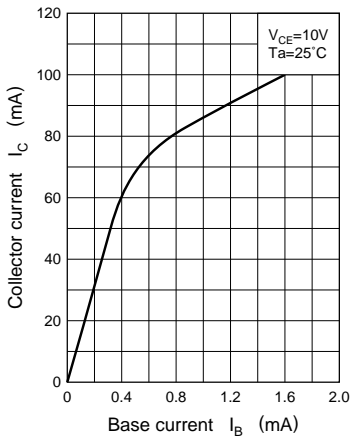

$V_{CE(sat)} - I_C$

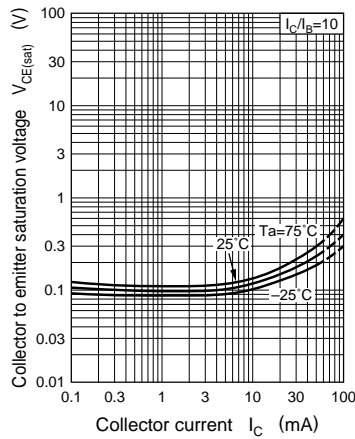

$I_B - V_{BE}$

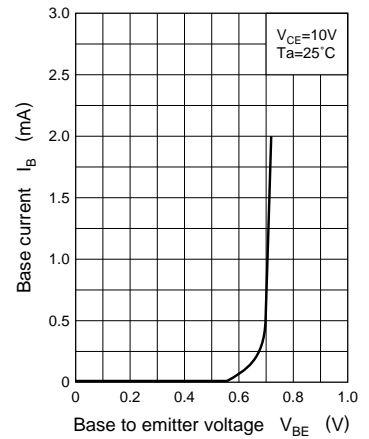

$h_{FE} - I_C$

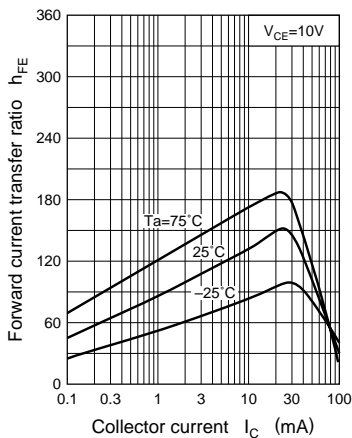

$f_T - I_E$

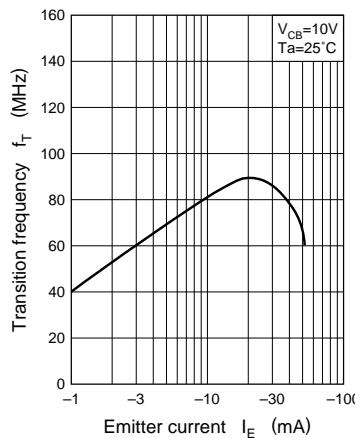

$C_{ob} - V_{CB}$

