

# **DEVICE SPECIFICATION**

## **TDA935X/6X/8X PS/N2 series** TV signal processor-Teletext decoder with embedded $\mu$ -Controller

Tentative Device Specification

2001 Apr 12

Version: 2.85

Previous date: 2000 Nov 29

## TV signal processor-Teletext decoder with embedded $\mu$ -Controller

## TDA935X/6X/8X PS/N2 series

### GENERAL DESCRIPTION

The various versions of the TDA935X/6X/8X PS/N2 series combine the functions of a TV signal processor together with a  $\mu$ -Controller and US Closed Caption decoder. Most versions have a Teletext decoder on board. The Teletext decoder has an internal RAM memory for 1 or 10 page text. The ICs are intended to be used in economy television receivers with 90° and 110° picture tubes.

The ICs have supply voltages of 8 V and 3.3 V and they are mounted in S-DIP envelope with 64 pins.

The features are given in the following feature list. The differences between the various ICs are given in the table on page 4.



### FEATURES

#### TV-signal processor

- Multi-standard vision IF circuit with alignment-free PLL demodulator
- Internal (switchable) time-constant for the IF-AGC circuit
- A choice can be made between versions with mono intercarrier sound FM demodulator and versions with QSS IF amplifier.
- The mono intercarrier sound versions have a selective FM-PLL demodulator which can be switched to the different FM sound frequencies (4.5/5.5/6.0/6.5 MHz). The quality of this system is such that the external band-pass filters can be omitted.
- Source selection between 'internal' CVBS and external CVBS or Y/C signals
- Integrated chrominance trap circuit
- Integrated luminance delay line with adjustable delay time
- Picture improvement features with peaking (with variable centre frequency and positive/negative overshoot ratio) and black stretching
- Integrated chroma band-pass filter with switchable centre frequency
- Only one reference (12 MHz) crystal required for the  $\mu$ -Controller, Teletext- and the colour decoder
- PAL/NTSC or multi-standard colour decoder with automatic search system
- Internal base-band delay line
- RGB control circuit with 'Continuous Cathode Calibration', white point and black level offset adjustment so that the colour temperature of the dark and the light parts of the screen can be chosen independently.
- Linear RGB or YUV input with fast blanking for external RGB/YUV sources. The Text/OSD signals are internally supplied from the  $\mu$ -Controller/Teletext decoder
- Contrast reduction possibility during mixed-mode of OSD and Text signals
- Horizontal synchronization with two control loops and alignment-free horizontal oscillator
- Vertical count-down circuit
- Vertical driver optimized for DC-coupled vertical output stages
- Horizontal and vertical geometry processing
- Horizontal and vertical zoom function for 16 : 9 applications
- Horizontal parallelogram and bow correction for large screen picture tubes
- Low-power start-up of the horizontal drive circuit

## TV signal processor-Teletext decoder with embedded $\mu$ -Controller

## TDA935X/6X/8X PS/N2 series

### $\mu$ -Controller

- 80C51  $\mu$ -controller core standard instruction set and timing
- 1  $\mu$ s machine cycle
- 32 - 128Kx8-bit late programmed ROM
- 3 - 12Kx8-bit Auxiliary RAM (shared with Display and Acquisition)
- Interrupt controller for individual enable/disable with two level priority
- Two 16-bit Timer/Counter registers
- One 16 bit Timer with 8-bit Pre-scaler
- WatchDog timer
- Auxiliary RAM page pointer
- 16-bit Data pointer
- Stand-by, Idle and Power Down (PD) mode
- 14 bits PWM for Voltage Synthesis Tuning
- 8-bit A/D converter
- 4 pins which can be programmed as general I/O pin, ADC input or PWM (6-bit) output

### Data Capture

- Text memory for 0, 1 or 10 pages
- In the 10 page versions inventory of transmitted Teletext pages stored in the Transmitted Page Table (TPT) and Subtitle Page Table (SPT)
- Data Capture for US Closed Caption
- Data Capture for 525/625 line WST, VPS (PDC system A) and Wide Screen Signalling (WSS) bit decoding
- Automatic selection between 525 WST/625 WST
- Automatic selection between 625 WST/VPS on line 16 of VBI
- Real-time capture and decoding for WST Teletext in Hardware, to enable optimized  $\mu$ -processor throughput
- Automatic detection of FASTEXT transmission
- Real-time packet 26 engine in Hardware for processing accented, G2 and G3 characters
- Signal quality detector for video and WST/VPS data types
- Comprehensive teletext language coverage
- Full Field and Vertical Blanking Interval (VBI) data capture of WST data

### Display

- Teletext and Enhanced OSD modes
- Features of level 1.5 WST and US Close Caption
- Serial and Parallel Display Attributes
- Single/Double/Quadruple Width and Height for characters
- Scrolling of display region
- Variable flash rate controlled by software
- Enhanced display features including overlining, underlining and italics
- Soft colours using CLUT with 4096 colour palette
- Globally selectable scan lines per row (9/10/13/16) and character matrix [12x10, 12x13, 12x16 (VxH)]
- Fringing (Shadow) selectable from N-S-E-W direction
- Fringe colour selectable
- Meshing of defined area
- Contrast reduction of defined area
- Cursor
- Special Graphics Characters with two planes, allowing four colours per character
- 32 software redefinable On-Screen display characters
- 4 WST Character sets (G0/G2) in single device (e.g. Latin, Cyrillic, Greek, Arabic)
- G1 Mosaic graphics, Limited G3 Line drawing characters
- WST Character sets and Closed Caption Character set in single device

TV signal processor-Teletext decoder with  
embedded  $\mu$ -Controller

TDA935X/6X/8X PS/N2 series

## FUNCTIONAL DIFFERENCE BETWEEN THE VARIOUS IC VERSIONS

IC VERSION (TDA)	9350	9351	9352	9353	9360	9361	9362	9363	9364	9365	9366	9367	9380	9381	9382	9383	9384	9385	9386	9387	9388	9389
TV range	90°	90°	90°	110°	90°	90°	110°	110°	110°	110°	90°	90°	90°	90°	90°	110°	110°	110°	110°	90°	110°	110°
Mono intercarrier multi-standard sound demodulator (4.5 - 6.5 MHz) with switchable centre frequency	√	√		√	√	√	√	√					√	√		√	√			√	√	
Audio switch	√	√		√	√	√	√	√					√	√		√	√			√	√	
Automatic Volume Levelling	√	√	√		√	√					√	√	√	√	√					√		
Automatic Volume Levelling or subcarrier output (for comb filter applications)				√			√	√	√	√						√	√	√	√		√	√
QSS sound IF amplifier with separate input and AGC circuit			√						√	√	√	√			√			√	√			√
AM sound demodulator without extra reference circuit										√									√			
PAL decoder	√	√	√	√	√	√	√	√	√	√	√	√	√	√	√	√	√	√	√			
SECAM decoder		√	√	√		√		√		√		√		√	√		√		√			
NTSC decoder	√	√	√	√	√	√	√	√	√	√	√	√	√	√	√	√	√	√	√	√	√	√
Horizontal geometry (E-W)				√			√	√	√	√						√	√	√	√		√	√
Horizontal and Vertical Zoom				√			√	√	√	√						√	√	√	√		√	√
ROM size	32-64 k	32-64 k	32-64 k	32-64 k	64-128k	64-128k	64-128k	64-128k	64-128k	64-128k	64-128k	64-128k	16-64 k	16-64 k	16-64 k	16-64 k	16-64 k	16-64 k	16-64 k	16-64 k	16-64 k	16-64 k
User RAM size	1 k	1 k	1 k	1 k	2 k	2 k	2 k	2 k	2 k	2 k	2 k	2 k	1 k	1 k	1 k	1 k	1 k	1 k	1 k	1 k	1 k	1 k
Teletext	1 page	1 page	1 page	1 page	10 page	10 page	10 page	10 page	10 page	10 page	10 page	10 page										
Closed captioning	√	√	√	√	√	√	√	√	√	√	√	√	√	√	√	√	√	√	√	√	√	√

TV signal processor-Teletext decoder with  
embedded  $\mu$ -Controller

## TDA935X/6X/8X PS/N2 series

## QUICK REFERENCE DATA

SYMBOL	PARAMETER	MIN.	TYP.	MAX.	UNIT
<b>Supply</b>					
$V_P$	supply voltages	–	8.0/3.3	–	V
$I_P$	supply current	–	135/60	–	mA
<b>Input voltages</b>					
$V_{iVIF(rms)}$	video IF amplifier sensitivity (RMS value)	–	75	–	$\mu$ V
$V_{iSIF(rms)}$	QSS sound IF amplifier sensitivity (RMS value)	–	60	–	$\mu$ V
$V_{iAUDIO(rms)}$	external audio input (RMS value)	–	500	–	mV
$V_{iCVBS(p-p)}$	external CVBS/Y input (peak-to-peak value)	–	1.0	–	V
$V_{iCHROMA(p-p)}$	external chroma input voltage (burst amplitude) (peak-to-peak value)	–	0.3	–	V
$V_{iRGB(p-p)}$	RGB inputs (peak-to-peak value)	–	0.7	–	V
$V_{iYIN(p-p)}$	luminance input signal (peak-to-peak value)	–	1.4	–	V
$V_{iUVIN(p-p)}$	U/V input signal (peak-to-peak value)	–	1.33/1.05	–	V
<b>Output signals</b>					
$V_{o(IFVO)(p-p)}$	demodulated CVBS output (peak-to-peak value)	–	2.5	–	V
$V_{o(QSSO)(rms)}$	sound IF intercarrier output in QSS versions (RMS value)	–	100	–	mV
$V_{o(AMOUT)(rms)}$	demodulated AM sound output in QSS versions (RMS value)	–	500	–	mV
$I_{o(AGCOUT)}$	tuner AGC output current range	0	–	5	mA
$V_{oRGB(p-p)}$	RGB output signal amplitudes (peak-to-peak value)	–	2.0	–	V
$I_{oHOUT}$	horizontal output current	10	–	–	mA
$I_{oVERT}$	vertical output current (peak-to-peak value)	1	–	–	mA
$I_{oEWD}$	EW drive output current	1.2	–	–	mA

TV signal processor-Teletext decoder with embedded  $\mu$ -Controller

TDA935X/6X/8X PS/N2 series

BLOCK DIAGRAM

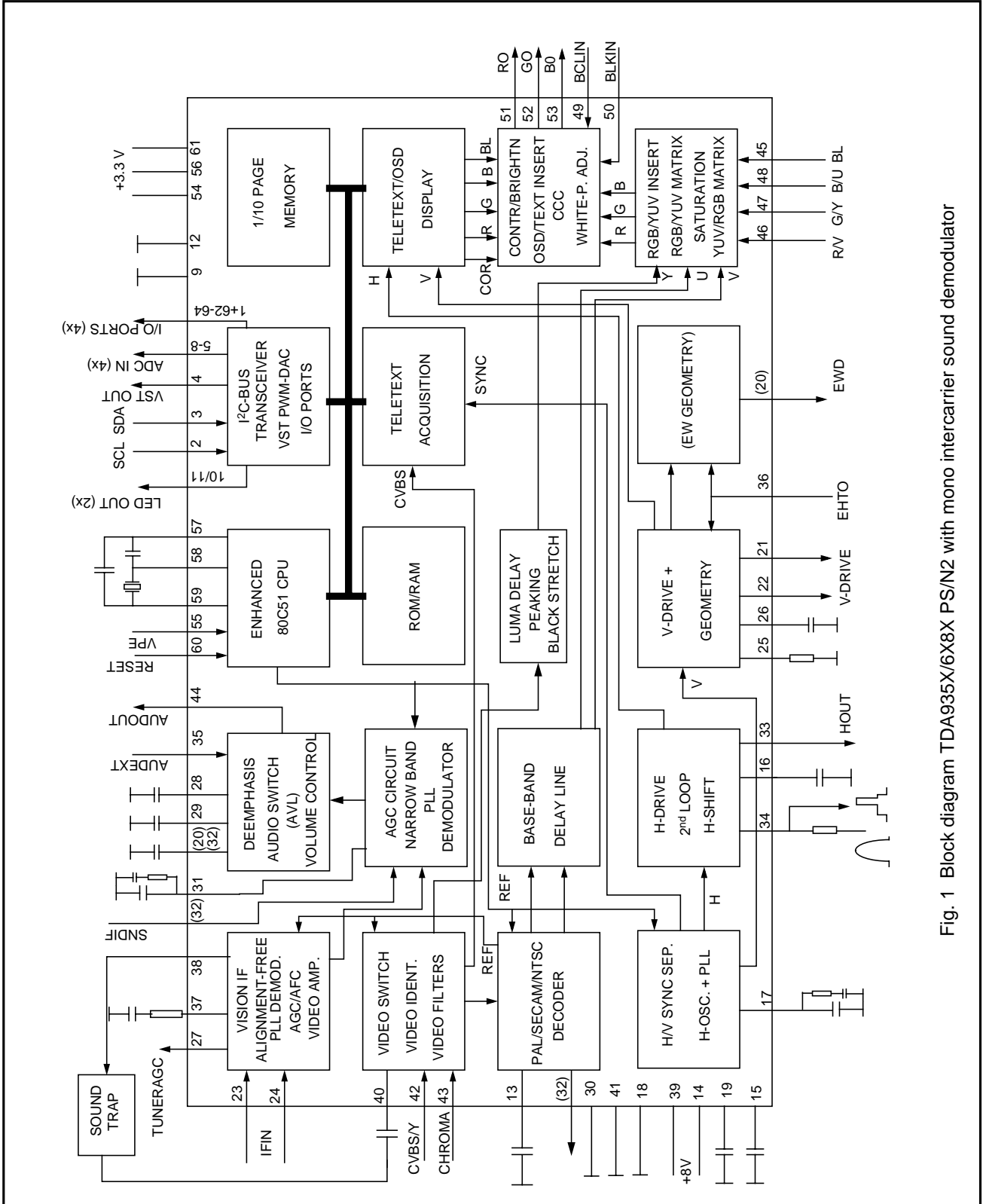

Fig. 1 Block diagram TDA935X/6X8X PS/N2 with mono intercarrier sound demodulator

TV signal processor-Teletext decoder with embedded  $\mu$ -Controller

TDA935X/6X/8X PS/N2 series

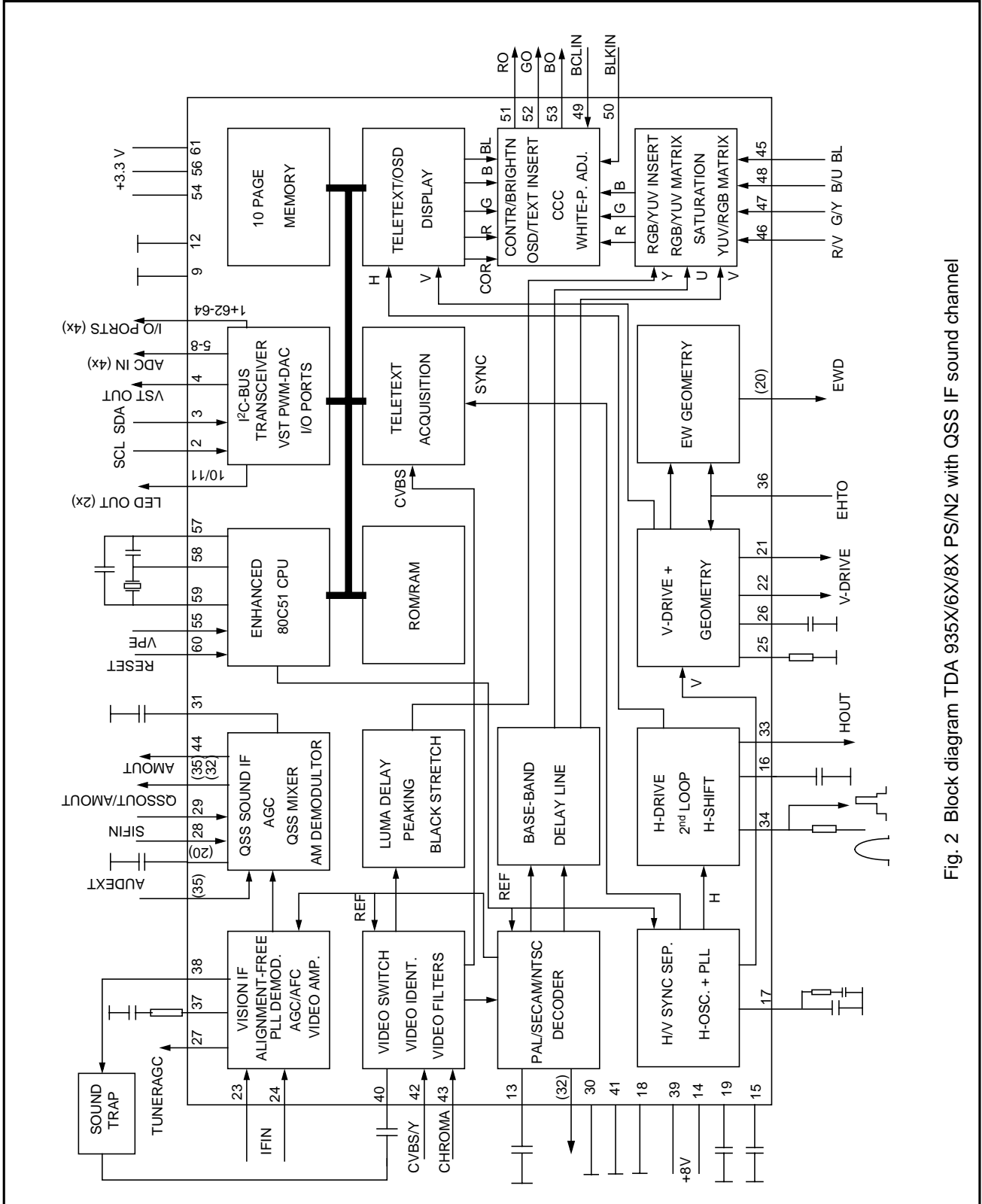

Fig. 2 Block diagram TDA 935X/6X/8X PS/N2 with QSS IF sound channel

TV signal processor-Teletext decoder with  
embedded  $\mu$ -Controller

## TDA935X/6X/8X PS/N2 series

## PINNING

SYMBOL	PIN	DESCRIPTION
P1.3/T1	1	port 1.3 or Counter/Timer 1 input
P1.6/SCL	2	port 1.6 or I <sup>2</sup> C-bus clock line
P1.7/SDA	3	port 1.7 or I <sup>2</sup> C-bus data line
P2.0/TPWM	4	port 2.0 or Tuning PWM output
P3.0/ADC0	5	port 3.0 or ADC0 input
P3.1/ADC1	6	port 3.1 or ADC1 input
P3.2/ADC2	7	port 3.2 or ADC2 input
P3.3/ADC3	8	port 3.3 or ADC3 input
VSSC/P	9	digital ground for $\mu$ -Controller core and periphery
P0.5	10	port 0.5 (8 mA current sinking capability for direct drive of LEDs)
P0.6	11	port 0.6 (8 mA current sinking capability for direct drive of LEDs)
VSSA	12	analog ground of Teletext decoder and digital ground of TV-processor
SECPLL	13	SECAM PLL decoupling
VP2	14	2 <sup>nd</sup> supply voltage TV-processor (+8V)
DECDIG	15	decoupling digital supply of TV-processor
PH2LF	16	phase-2 filter
PH1LF	17	phase-1 filter
GND3	18	ground 3 for TV-processor
DECBG	19	bandgap decoupling
AVL/EWD <sup>(1)</sup>	20	Automatic Volume Levelling /East-West drive output
VDRB	21	vertical drive B output
VDRA	22	vertical drive A output
IFIN1	23	IF input 1
IFIN2	24	IF input 2
IREF	25	reference current input
VSC	26	vertical sawtooth capacitor
TUNERAGC	27	tuner AGC output
AUDEEM/SIFIN1 <sup>(1)</sup>	28	audio deemphasis or SIF input 1
DECSDEM/SIFIN2 <sup>(1)</sup>	29	decoupling sound demodulator or SIF input 2
GND2	30	ground 2 for TV processor
SNDPLL/SIFAGC <sup>(1)</sup>	31	narrow band PLL filter /AGC sound IF
AVL/SNDIF/REF0/ AMOUT <sup>(1)</sup>	32	Automatic Volume Levelling / sound IF input / subcarrier reference output /AM output (non controlled)
HOUT	33	horizontal output
FBISO	34	flyback input/sandcastle output
AUDEXT/ QSSO/AMOUT <sup>(1)</sup>	35	external audio input /QSS intercarrier out /AM audio output (non controlled)
EHTO	36	EHT/overvoltage protection input
PLLIF	37	IF-PLL loop filter
IFVO/SVO	38	IF video output / selected CVBS output
VP1	39	main supply voltage TV-processor (+8 V)
CVBSINT	40	internal CVBS input
GND1	41	ground 1 for TV-processor
CVBS/Y	42	external CVBS/Y input
CHROMA	43	chrominance input (SVHS)
AUDOUT /AMOUT <sup>(1)</sup>	44	audio output /AM audio output (volume controlled)



TV signal processor-Teletext decoder with  
embedded  $\mu$ -Controller

## TDA935X/6X/8X PS/N2 series

SYMBOL	PIN	DESCRIPTION
INSSW2	45	2 <sup>nd</sup> RGB / YUV insertion input
R2/VIN	46	2 <sup>nd</sup> R input / V (R-Y) input
G2/YIN	47	2 <sup>nd</sup> G input / Y input
B2/UIIN	48	2 <sup>nd</sup> B input / U (B-Y) input
BCLIN	49	beam current limiter input / (V-guard input, note 2)
BLKIN	50	black current input / (V-guard input, note 2)
RO	51	Red output
GO	52	Green output
BO	53	Blue output
VDDA	54	analog supply of Teletext decoder and digital supply of TV-processor (3.3 V)
VPE	55	OTP Programming Voltage
VDDC	56	digital supply to core (3.3 V)
OSCGND	57	oscillator ground supply
XTALIN	58	crystal oscillator input
XTALOUT	59	crystal oscillator output
RESET	60	reset
VDDP	61	digital supply to periphery (+3.3 V)
P1.0/INT1	62	port 1.0 or external interrupt 1 input
P1.1/T0	63	port 1.1 or Counter/Timer 0 input
P1.2/INT0	64	port 1.2 or external interrupt 0 input

**Note**

1. The function of pin 20, 28, 29, 31, 32, 35 and 44 is dependent on the IC version (mono intercarrier FM demodulator / QSS IF amplifier and East-West output or not) and on some software control bits. The valid combinations are given in table 1.
2. The vertical guard function can be controlled via pin 49 or pin 50. The selection is made by means of the IVG bit in subaddress 2BH.

**Table 1** Pin functions for various versions

IC version	FM-PLL version				QSS version					
	N		Y		N		Y			
East-West Y/N										
CMB1/CMB0 bits	00	01/10/11	00	01/10/11	00	01/10/11	00	01/10/11		
AM bit	–	–	–	–	–	0	1	–	0	1
Pin 20	AVL		EWD		AVL		EWD			
Pin 28	AUDEEM				SIFIN1					
Pin 29	DECSDEM				SIFIN2					
Pin 31	SNDPLL				SIFAGC					
Pin 32	SNDIF <sup>(1)</sup>	REFO <sup>(2)</sup>	AVL/SNDIF <sup>(1)</sup>	REFO <sup>(2)</sup>	AMOUT	REFO <sup>(2)</sup>	AMOUT	REFO <sup>(2)</sup>		
Pin 35	AUDEXT				AUDEXT	QSSO	AMOUT	AUDEXT	QSSO	AMOUT
Pin 44	AUDOUT				controlled AM or audio out					

**Note**

1. When additional (external) selectivity is required for FM-PLL system pin 32 can be used as sound IF input. This function is selected by means of SIF bit in subaddress 28H.
2. The reference output signal is only available for the CMB1/CMB0 setting of 0/1. For the other settings this pin is a switch output (see also table 67).

TV signal processor-Teletext decoder with embedded  $\mu$ -Controller

TDA935X/6X/8X PS/N2 series

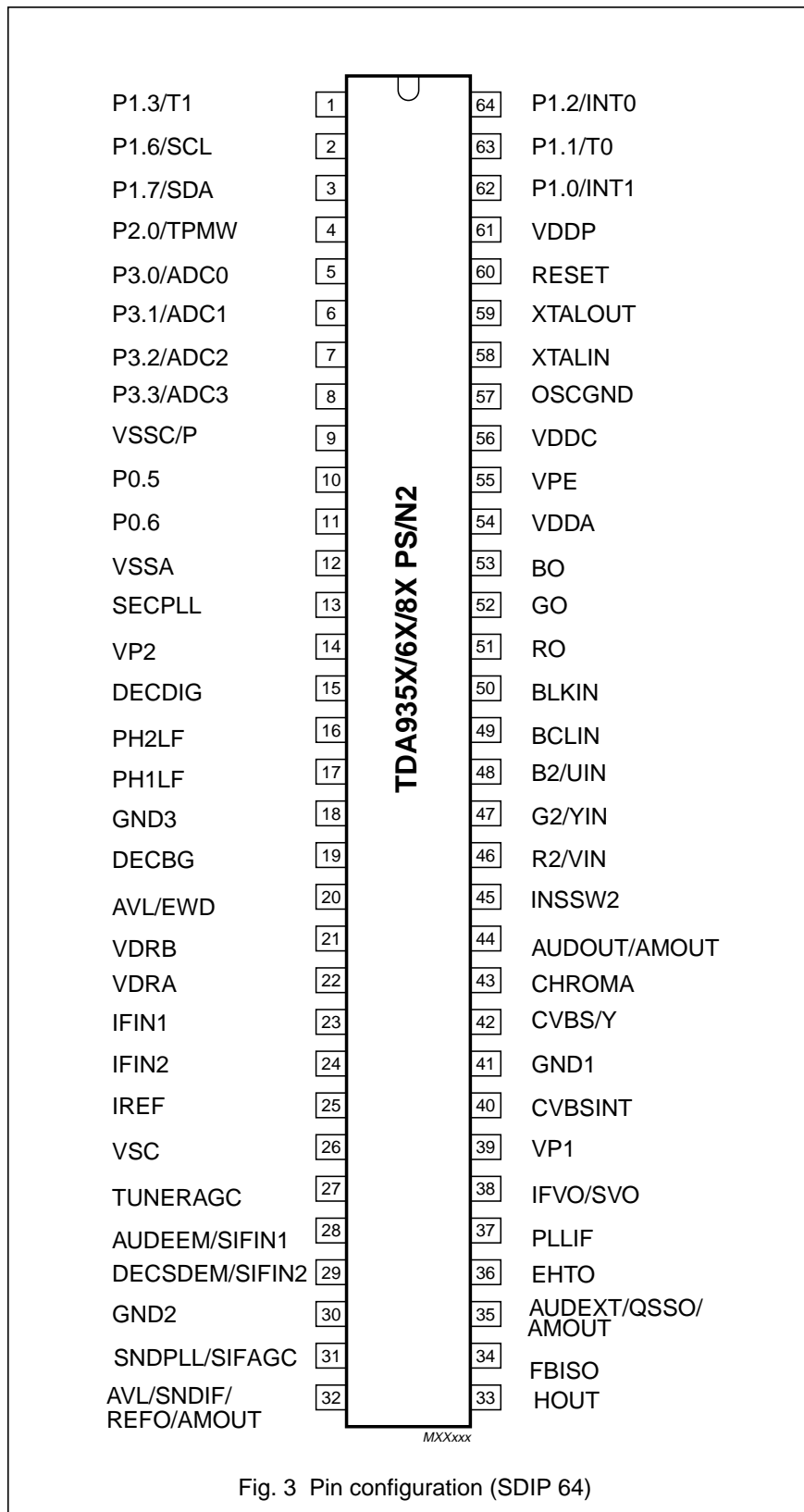

Fig. 3 Pin configuration (SDIP 64)

# TV signal processor-Teletext decoder with embedded $\mu$ -Controller

## TDA935X/6X/8X PS/N2 series

### FUNCTIONAL DESCRIPTION OF THE 80C51

The functionality of the micro-controller used on this device is described here with reference to the industry standard 80C51 micro-controller. A full description of its functionality can be found in the 80C51 based 8-bit micro-controllers - Philips Semiconductors (ref. IC20).

#### Features of the 80c51

- 80C51 micro-controller core standard instruction set and timing.
- 1 $\mu$ s machine cycle.
- Maximum 128K x 8-bit Program ROM.
- Maximum of 12K x 8-bit Auxiliary RAM.
  - 2K (OSD only version) Auxiliary RAM, maximum of 1.25K required for Display
  - 3K (1 page teletext version) Auxiliary RAM, maximum of 2K required for Display
  - 12K (10 page teletext version) Auxiliary RAM, maximum of 10K required for Display
- 8-Level Interrupt Controller for individual enable/disable with two level priority.
- Two 16-bit Timer/Counters.
- Additional 16-bit Timer with 8-bit Pre-scaler.
- WatchDog Timer.
- Auxiliary RAM Page Pointer.
- 16-bit Data pointer
- Idle, Stand-by and Power-Down modes.
- 13 General I/O.
- Four 6-bit Pulse Width Modulator (PWM) outputs for control of TV analogue signals.
- One 14-bit PWM for Voltage Synthesis tuner control.
- 8-bit ADC with 4 multiplexed inputs.
- 2 high current outputs for directly driving LED's etc.
- I<sup>2</sup>C Byte Level bus interface.

#### Memory Organisation

The device has the capability of a maximum of 128K Bytes of PROGRAM ROM and 12K Bytes of DATA RAM. The OSD (& Closed Caption) only version has a 2K RAM and a maximum of 64K ROM, the 1 page teletext version has a 3K RAM and also a maximum of 64K ROM whilst the 10 page teletext version has a 12K RAM and a maximum of 128K ROM.

#### ROM Organisation

The 64K device has a continuous address space from 0 to 64K. The 128K is arranged in four banks of 32K. One of

the 32K banks is common and is always addressable. The other three banks (Bank0, Bank1, Bank2) can be accessed by selecting the right bank via the SFR ROMBK bits 1/0.

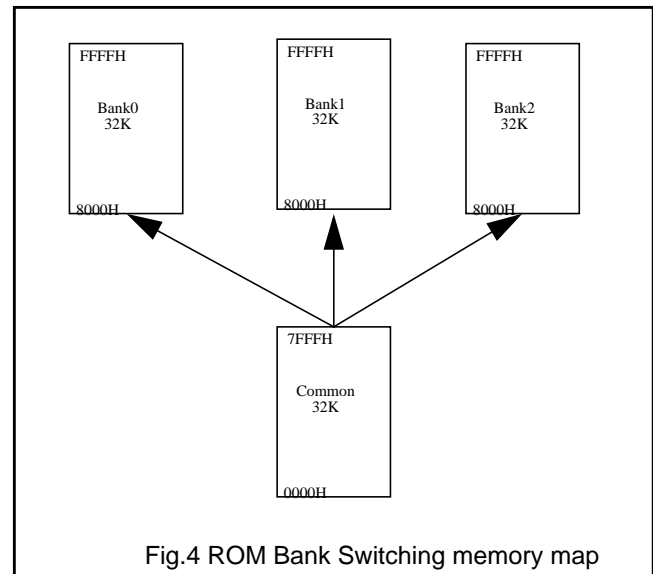

#### RAM Organisation

The Internal Data RAM is organised into two areas, Data Memory and Special Function Registers (SFRs) as shown in Fig.5.

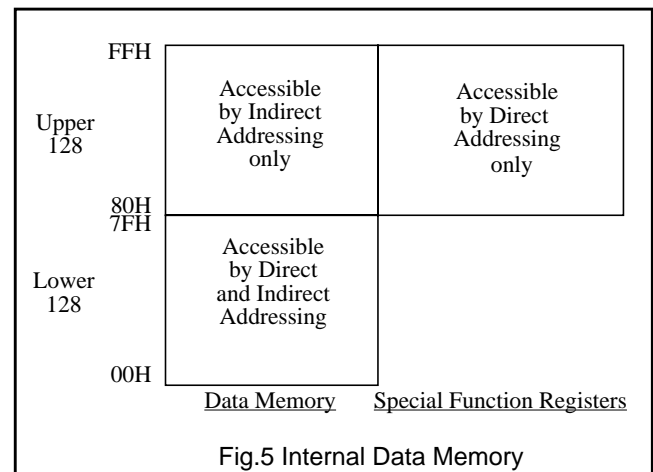

#### DATA MEMORY

The Data memory is 256 x 8-bits and occupies the address range 00 to FF Hex when using Indirect addressing and 00 to 7F Hex when using direct addressing. The SFRs occupy the address range 80 Hex to FF Hex and are accessible using Direct addressing only. The lower 128 Bytes of Data memory are mapped as shown in Fig.6. The lowest 32

# TV signal processor-Teletext decoder with embedded $\mu$ -Controller TDA935X/6X/8X PS/N2 series

bytes are grouped into 4 banks of 8 registers, the next 16 bytes above the register banks form a block of bit addressable memory space. The upper 128 bytes are not allocated for any special area or functions.

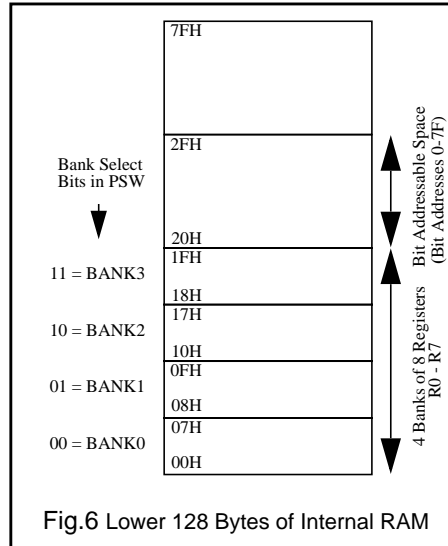

Fig.6 Lower 128 Bytes of Internal RAM

### SFR MEMORY

The Special Function Register (SFR) space is used for port latches, counters/timers, peripheral control, data capture and display. These registers can only be accessed by direct addressing. Sixteen of the addresses in the SFR space are both bit and byte addressable. The bit addressable SFRs are those whose address ends in 0H or 8H. A summary of the SFR map in address order is shown in Table 2.

ADD	R/W	Names	BIT7	BIT6	BIT5	BIT4	BIT3	BIT2	BIT1	BIT0
80H	R/W	<b>P0</b>	Reserved	P0<6>	P0<5>	Reserved	Reserved	Reserved	Reserved	Reserved
81H	R/W	<b>SP</b>	SP<7>	SP<6>	SP<5>	SP<4>	SP<3>	SP<2>	SP<1>	SP<0>
82H	R/W	<b>DPL</b>	DPL<7>	DPL<6>	DPL<5>	DPL<4>	DPL<3>	DPL<2>	DPL<1>	DPL<0>
83H	R/W	<b>DPH</b>	DPH<7>	DPH<6>	DPH<5>	DPH<4>	DPH<3>	DPH<2>	DPH<1>	DPH<0>
84H	R/W	<b>IEN1</b>	-	-	-	-	-	-	-	ET2
85H	R/W	<b>IP1</b>	-	-	-	-	-	-	-	PT2
87H	R/W	<b>PCON</b>	0	ARD	RF1	WLE	GF1	GF0	PD	IDL
88H	R/W	<b>TCON</b>	TF1	TR1	TF0	TR0	IE1	IT1	IE0	IT0
89H	R/W	<b>TMOD</b>	GATE	C/T	M1	M0	GATE	C/T	M1	M0
8AH	R/W	<b>TL0</b>	TL0<7>	TL0<6>	TL0<5>	TL0<4>	TL0<3>	TL0<2>	TL0<1>	TL0<0>
8BH	R/W	<b>TL1</b>	TL1<7>	TL1<6>	TL1<5>	TL1<4>	TL1<3>	TL1<2>	TL1<1>	TL1<0>
8CH	R/W	<b>TH0</b>	TH0<7>	TH0<6>	TH0<5>	TH0<4>	TH0<3>	TH0<2>	TH0<1>	TH0<0>
8DH	R/W	<b>TH1</b>	TH1<7>	TH1<6>	TH1<5>	TH1<4>	TH1<3>	TH1<2>	TH1<1>	TH1<0>
90H	R/W	<b>P1</b>	P1<7>	P1<6>	Reserved	Reserved	P1<3>	P1<2>	P1<1>	P1<0>
91H	R/W	<b>TP2L</b>	TP2L<7>	TP2L<6>	TP2L<5>	TP2L<4>	TP2L<3>	TP2L<2>	TP2L<1>	TP2L<0>

Table 2 SFR Map

# TV signal processor-Teletext decoder with embedded $\mu$ -Controller

## TDA935X/6X/8X PS/N2 series

ADD	R/W	Names	BIT7	BIT6	BIT5	BIT4	BIT3	BIT2	BIT1	BIT0
92H	R/W	<b>TP2H</b>	TP2H<15>	TP2H<14>	TP2H<13>	TP2H<12>	TP2H<11>	TP2H<10>	TP2H<9>	TP2H<8>
93H	R/W	<b>TP2PR</b>	TP2PR<7>	TP2PR<6>	TP2PR<5>	TP2PR<4>	TP2PR<3>	TP2PR<2>	TP2PR<1>	TP2PR<0>
94H	R/W	<b>TP2CRL</b>	-	-	-	-	-	-	TP2CRL<1>	TP2CRL<0>
96H	R/W	<b>P0CFGA</b>	Reserved	P0CFGA<6>	P0CFGA<5>	Reserved	Reserved	Reserved	Reserved	Reserved
97H	R/W	<b>P0CFGB</b>	Reserved	P0CFGB<6>	P0CFGB<5>	Reserved	Reserved	Reserved	Reserved	Reserved
98H	R/W	<b>SADB</b>	-	-	-	DC_COMP	SAD<3>	SAD<2>	SAD<1>	SAD<0>
9CH	R	<b>TP2CL</b>	TP2CL<7>	TP2CL<6>	TP2CL<5>	TP2CL<4>	TP2CL<3>	TP2CL<2>	TP2CL<1>	TP2CL<0>
9DH	R	<b>TP2CH</b>	TP2CH<7>	TP2CH<6>	TP2CH<5>	TP2CH<4>	TP2CH<3>	TP2CH<2>	TP2CH<1>	TP2CH<0>
9EH	R/W	<b>P1CFGA</b>	P1CFGA<7>	P1CFGA<6>	Reserved	Reserved	P1CFGA<3>	P1CFGA<2>	P1CFGA<1>	P1CFGA<0>
9FH	R/W	<b>P1CFGB</b>	P1CFGB<7>	P1CFGB<6>	Reserved	Reserved	P1CFGB<3>	P1CFGB<2>	P1CFGB<1>	P1CFGB<0>
A0H	R/W	<b>P2</b>	Reserved	-	-	-	-	-	-	P2<0>
A6H	R/W	<b>P2CFGA</b>	Reserved	P2CFGA<6>	P2CFGA<5>	P2CFGA<4>	P2CFGA<3>	P2CFGA<2>	P2CFGA<1>	P2CFGA<0>
A7H	R/W	<b>P2CFGB</b>	Reserved	P2CFGB<6>	P2CFGB<5>	P2CFGB<4>	P2CFGB<3>	P2CFGB<2>	P2CFGB<1>	P2CFGB<0>
A8H	R/W	<b>IE</b>	EA	EBUSY	ES2	ECC	ET1	EX1	ET0	EX0
B0H	R/W	<b>P3</b>	Reserved	Reserved	Reserved	Reserved	P3<3>	P3<2>	P3<1>	P3<0>
B2H	R/W	<b>TXT18</b>	NOT<3>	NOT<2>	NOT<1>	NOT<0>	0	0	BS<1>	BS<0>
B3H	R/W	<b>TXT19</b>	TEN	TC<2>	TC<1>	TC<0>	0	0	TS<1>	TS<0>
B4H	R/W	<b>TXT20</b>	DRCS ENABLE	OSD PLANES	0	0	OSD LANG ENABLE	OSD LAN<2>	OSD LAN<1>	OSD LAN<0>
B5H	R/W	<b>TXT21</b>	DISP LINE<1>	DISP LINES<0>	CHAR SIZE<1>	CHAR SIZE<0>	Reserved	CC ON	I2C PORT0	CC/TXT
B6H	R	<b>TXT22</b>	GPF1<7>	GPF1<6>	GPF1<5>	GPF1<4>	GPF1<3>	GPF1<2>	GPF1<1>	GPF1<0>
B7H	R/W	<b>CCLIN</b>	0	0	0	CS<4>	CS<3>	CS<2>	CS<1>	CS<0>
B8H	R/W	<b>IP</b>	0	PBUSY	PES2	PCC	PT1	PX1	PT0	PX0
B9H	R/W	<b>TXT17</b>	0	FORCE ACQ<1>	FORCE ACQ<0>	FORCE DISP<1>	FORCE DISP<0>	SCREEN COL<2>	SCREEN COL<1>	SCREEN COL<0>
BAH	R	<b>WSS1</b>	0	0	0	WSS<3:0> ERROR	WSS<3>	WSS<2>	WSS<1>	WSS<0>
BBH	R	<b>WSS2</b>	0	0	0	WSS<7:4> ERROR	WSS<7>	WSS<6>	WSS<5>	WSS<4>
BCH	R	<b>WSS3</b>	WSS<13:11> ERROR	WSS<13>	WSS<12>	WSS<11>	WSS<10:8> ERROR	WSS<10>	WSS<9>	WSS<8>
BEH	R/W	<b>P3CFGA</b>	Reserved	Reserved	Reserved	Reserved	P3CFGA<3>	P3CFGA<2>	P3CFGA<1>	P3CFGA<0>
BFH	R/W	<b>P3CFGB</b>	Reserved	Reserved	Reserved	Reserved	P3CFGB<3>	P3CFGB<2>	P3CFGB<1>	P3CFGB<0>
C0H	R/W	<b>TXT0</b>	X24 POSN	DISPLAY X24	AUTO FRAME	DISABLE HEADER ROLL	DISPLAY STATUS ROW ONLY	DISABLE FRAME	VPS ON	INV ON

**Table 2** SFR Map

# TV signal processor-Teletext decoder with embedded $\mu$ -Controller

## TDA935X/6X/8X PS/N2 series

ADD	R/W	Names	BIT7	BIT6	BIT5	BIT4	BIT3	BIT2	BIT1	BIT0
C1H	R/W	<b>TXT1</b>	EXT PKT OFF	8 BIT	ACQ OFF	X26 OFF	FULL FIELD	FIELD POLARITY	H POLARITY	V POLARITY
C2H	R/W	<b>TXT2</b>	ACQ BANK	REQ<3>	REQ<2>	REQ<1>	REQ<0>	SC<2>	SC<1>	SC<0>
C3H	W	<b>TXT3</b>	-	-	-	PRD<4>	PRD<3>	PRD<2>	PRD<1>	PRD<0>
C4H	R/W	<b>TXT4</b>	OSD BANK ENABLE	QUAD WIDTH ENABLE	EAST/WEST T	DISABLE DOUBLE HEIGHT	B MESH ENABLE	C MESH ENABLE	TRANS ENABLE	SHADOW ENABLE
C5H	R/W	<b>TXT5</b>	BKGND OUT	BKGND IN	CORB OUT	CORB IN	TEXT OUT	TEXT IN	PICTURE ON OUT	PICTURE ON IN
C6H	R/W	<b>TXT6</b>	BKGND OUT	BKGND IN	CORB OUT	CORB IN	TEXT OUT	TEXT IN	PICTURE ON OUT	PICTURE ON IN
C7H	R/W	<b>TXT7</b>	STATUS ROW TOP	CURSOR ON	REVEAL	BOTTOM/TOP	DOUBLE HEIGHT	BOX ON 24	BOX ON 1-23	BOX ON 0
C8H	R/W	<b>TXT8</b>	(Reserved) 0	FLICKER STOP ON	HUNT	DISABLE SPANISH	PKT 26 RECEIVED	WSS RECEIVED	WSS ON	CVBS1/ CVBS0
C9H	R/W	<b>TXT9</b>	CURSOR FREEZE	CLEAR MEMORY	A0	R<4>	R<3>	R<2>	R<1>	R<0>
CAH	R/W	<b>TXT10</b>	0	0	C<5>	C<4>	C<3>	C<2>	C<1>	C<0>
CBH	R/W	<b>TXT11</b>	D<7>	D<6>	D<5>	D<4>	D<3>	D<2>	D<1>	D<0>
CCH	R	<b>TXT12</b>	525/625 SYNC	ROM VER<4>	ROM VER<3>	ROM VER<2>	ROM VER<1>	ROM VER<0>	1	VIDEO SIGNAL QUALITY
CDH	R/W	<b>TXT14</b>	0	0	0	DISPLAY BANK	PAGE<3>	PAGE<2>	PAGE<1>	PAGE<0>
CEH	R/W	<b>TXT15</b>	0	0	0	MICRO BANK	BLOCK<3>	BLOCK<2>	BLOCK<1>	BLOCK<0>
D0H	R/W	<b>PSW</b>	C	AC	F0	RS1	RS0	OV	-	P
D2H	R/W	<b>TDACL</b>	TD<7>	TD<6>	TD<5>	TD<4>	TD<3>	TD<2>	TD<1>	TD<0>
D3H	R/W	<b>TDACH</b>	TPWE	1	TD<13>	TD<12>	TD<11>	TD<10>	TD<9>	TD<8>
D5H	R/W	<b>PWM0</b>	PW0E	1	PW0V<5>	PW0V<4>	PW0V<3>	PW0V<2>	PW0V<1>	PW0V<0>
D6H	R/W	<b>PWM1</b>	PW1E	1	PW1V<5>	PW1V<4>	PW1V<3>	PW1V<2>	PW1V<1>	PW1V<0>
D7H	R	<b>CCDAT1</b>	CCD1<7>	CCD1<6>	CCD1<5>	CCD1<4>	CCD1<3>	CCD1<2>	CCD1<1>	CCD1<0>
D8H	R/W	<b>SICON</b>	CR<2>	ENSI	STA	STO	SI	AA	CR<1>	CR<0>
D9H	R	<b>SISTA</b>	STAT<4>	STAT<3>	STAT<2>	STAT<1>	STAT<0>	0	0	0
DAH	R/W	<b>SIDAT</b>	DAT<7>	DAT<6>	DAT<5>	DAT<4>	DAT<3>	DAT<2>	DAT<1>	DAT<0>
DBH	R/W	<b>S1ADR</b>	ADR<6>	ADR<5>	ADR<4>	ADR<3>	ADR<2>	ADR<1>	ADR<0>	GC
DCH	R/W	<b>PWM3</b>	PW3E	1	PW3V<5>	PW3V<4>	PW3V<3>	PW3V<2>	PW3V<1>	PW3V<0>
E0H	R/W	<b>ACC</b>	ACC<7>	ACC<6>	ACC<5>	ACC<4>	ACC<3>	ACC<2>	ACC<1>	ACC<0>
E4H	R/W	<b>PWM2</b>	PW2E	1	PW2V<5>	PW2V<4>	PW2V<3>	PW2V<2>	PW2V<1>	PW2V<0>

**Table 2** SFR Map

# TV signal processor-Teletext decoder with embedded $\mu$ -Controller

## TDA935X/6X/8X PS/N2 series

ADD	R/W	Names	BIT7	BIT6	BIT5	BIT4	BIT3	BIT2	BIT1	BIT0
E7H	R	<b>CCDAT2</b>	CCD2<7>	CCD2<6>	CCD2<5>	CCD2<4>	CCD2<3>	CCD2<2>	CCD2<1>	CCD2<0>
E8H	R/W	<b>SAD</b>	VHI	CH<1>	CH<0>	ST	SAD<7>	SAD<6>	SAD<5>	SAD<4>
F0H	R/W	<b>B</b>	B<7>	B<6>	B<5>	B<4>	B<3>	B<2>	B<1>	B<0>
F8H	R/W	<b>TXT13</b>	VPS RECEIVED	PAGE CLEARING	525 DISPLAY	525 TEXT	625 TEXT	PKT 8/30	FASTTEXT	0
FAH	R/W	<b>XRAMP</b>	XRAMP<7>	XRAMP<6>	XRAMP<5>	XRAMP<4>	XRAMP<3>	XRAMP<2>	XRAMP<1>	XRAMP<0>
FBH	R/W	<b>ROMBK</b>	STANDBY	IIC_LUT<1>	IIC_LUT<0>	0	0	0	ROMBK<1>	ROMBK<0>
FDH	R	<b>TEST</b>	TEST<7>	TEST<6>	TEST<5>	TEST<4>	TEST<3>	TEST<2>	TEST<1>	TEST<0>
FEH	W	<b>WDTKEY</b>	WKEY<7>	WKEY<6>	WKEY<5>	WKEY<4>	WKEY<3>	WKEY<2>	WKEY<1>	WKEY<0>
FFH	R/W	<b>WDT</b>	WDV<7>	WDV<6>	WDV<5>	WDV<4>	WDV<3>	WDV<2>	WDV<1>	WDV<0>

**Table 2** SFR Map

A description of each of the SFR bits is shown in Table 3, The SFRs are in alphabetical order.

Names	ADD	BIT7	BIT6	BIT5	BIT4	BIT3	BIT2	BIT1	BIT0	RESET
<b>ACC</b>	E0H	ACC<7>	ACC<6>	ACC<5>	ACC<4>	ACC<3>	ACC<2>	ACC<1>	ACC<0>	<b>00H</b>
ACC<7:0>	Accumulator value.									
<b>B</b>	F0H	B<7>	B<6>	B<5>	B<4>	B<3>	B<2>	B<1>	B<0>	<b>00H</b>
B<7:0>	B Register value.									
<b>CCDAT1</b>	D7H	CCD1<7>	CCD1<6>	CCD1<5>	CCD1<4>	CCD1<3>	CCD1<2>	CCD1<1>	CCD1<0>	<b>00H</b>
CCD1<7:0>	Closed Caption first data byte.									
<b>CCDAT2</b>	E7H	CCD2<7>	CCD2<6>	CCD2<5>	CCD2<4>	CCD2<3>	CCD2<2>	CCD2<1>	CCD2<0>	<b>00H</b>
CCD2<7:0>	Closed Caption second data byte.									
<b>CCLIN</b>	B7H	0	0	0	CS<4>	CS<3>	CS<2>	CS<1>	CS<0>	<b>15H</b>
CS<4:0>	Closed Caption Slice line using 525 line number.									
<b>DPH</b>	83H	DPH<7>	DPH<6>	DPH<5>	DPH<4>	DPH<3>	DPH<2>	DPH<1>	DPH<0>	<b>00H</b>
DPH<7:0>	Data Pointer High byte, used with DPL to address display and auxiliary memory.									
<b>DPL</b>	82H	DPL<7>	DPL<6>	DPL<5>	DPL<4>	DPL<3>	DPL<2>	DPL<1>	DPL<0>	<b>00H</b>
DPL<7:0>	Data pointer low byte, used with DPH to address display and auxiliary memory.									
<b>IE</b>	A8H	EA	EBUSY	ES2	ECC	ET1	EX1	ET0	EX0	<b>00H</b>
EA	Disable all interrupts (0), or use individual interrupt enable bits (1).									
EBUSY	Enable BUSY Interrupt.									
ES2	Enable PC Interrupt.									
ECC	Enable Closed Caption Interrupt.									

**Table 3** SFR Bit description

TV signal processor-Teletext decoder with  
embedded  $\mu$ -Controller

## TDA935X/6X/8X PS/N2 series

Names	ADD	BIT7	BIT6	BIT5	BIT4	BIT3	BIT2	BIT1	BIT0	RESET
ET1	Enable Timer 1 Interrupt.									
EX1	Enable External Interrupt 1.									
ET0	Enable Timer 0 Interrupt.									
EX0	Enable External Interrupt 0.									
<b>IEN1</b>	84H	-	-	-	-	-	-	-	ET2	<b>00H</b>
ET2	Enable Timer 2 Interrupt.									
<b>IP</b>	B8H	0	PBUSY	PES2	PCC	PT1	PX1	PT0	PX0	<b>00H</b>
PBUSY	Priority EBUSY Interrupt.									
PES2	Priority ES2 Interrupt.									
PCC	Priority ECC Interrupt.									
PT1	Priority Timer 1 Interrupt.									
PX1	Priority External Interrupt 1.									
PT0	Priority Timer 0 Interrupt.									
PX0	Priority External Interrupt 0.									
<b>IP1</b>	85H	-	-	-	-	-	-	-	PT2	<b>00H</b>
PT2	Priority Timer 2 Interrupt.									
<b>P0</b>	80H	Reserved	P0<6>	P0<5>	Reserved	Reserved	Reserved	Reserved	Reserved	<b>FFH</b>
P0<6:5>	Port 0 I/O register connected to external pins.									
<b>P1</b>	90H	P1<7>	P1<6>	Reserved	Reserved	P1<3>	P1<2>	P1<1>	P1<0>	<b>FFH</b>
P1<7:6>	Port 1 I/O register connected to external pins.									
P1<3:0>	Port 1 I/O register connected to external pins.									
<b>P2</b>	A0H	Reserved	P2<6>	P2<5>	P2<4>	P2<3>	P2<2>	P2<1>	P2<0>	<b>FFH</b>
P2<6:0>	Port 2 I/O register connected to external pins.									
<b>P3</b>	B0H	Reserved	Reserved	Reserved	Reserved	P3<3>	P3<2>	P3<1>	P3<0>	<b>FFH</b>
P3<3:0>	Port 3 I/O register connected to external pins.									
<b>P0CFGA</b>	96H	Reserved	P0CFGA<6>	P0CFGA<5>	Reserved	Reserved	Reserved	Reserved	Reserved	<b>FFH</b>
<b>P0CFGB</b>	97H	Reserved	P0CFGB<6>	P0CFGB<5>	Reserved	Reserved	Reserved	Reserved	Reserved	<b>00H</b>
P0CFGB<x>/P0CFGA<x> = 00			MODE 0 Open Drain.							
P0CFGB<x>/P0CFGA<x> = 01			MODE 1 Quasi Bi-Directional.							
P0CFGB<x>/P0CFGA<x> = 10			MODE2 High Impedance.							
P0CFGB<x>/P0CFGA<x> = 11			MODE3 Push Pull.							
<b>P1CFGA</b>	9EH	P1CFGA<7>	P1CFGA<6>	Reserved	Reserved	P1CFGA<3>	P1CFGA<2>	P1CFGA<1>	P1CFGA<0>	<b>FFH</b>
<b>P1CFGB</b>	9FH	P1CFGB<7>	P1CFGB<6>	Reserved	Reserved	P1CFGB<3>	P1CFGB<2>	P1CFGB<1>	P1CFGB<0>	<b>00H</b>

Table 3 SFR Bit description



TV signal processor-Teletext decoder with  
embedded  $\mu$ -Controller

## TDA935X/6X/8X PS/N2 series

Names	ADD	BIT7	BIT6	BIT5	BIT4	BIT3	BIT2	BIT1	BIT0	RESET
P1CFGB<x>/P1CFGA<x> = 00		MODE 0 Open Drain.								
P1CFGB<x>/P1CFGA<x> = 01		MODE 1 Quasi Bi-Directional.								
P1CFGB<x>/P1CFGA<x> = 10		MODE2 High Impedance.								
P1CFGB<x>/P1CFGA<x> = 11		MODE3 Push Pull.								
<b>P2CFGA</b>	A6H	Reserved	P2CFGA<6>	P2CFGA<5>	P2CFGA<4>	P2CFGA<3>	P2CFGA<2>	P2CFGA<1>	P2CFGA<0>	<b>FFH</b>
<b>P2CFGB</b>	A7H	Reserved	P2CFGB<6>	P2CFGB<5>	P2CFGB<4>	P2CFGB<3>	P2CFGB<2>	P2CFGB<1>	P2CFGB<0>	<b>00H</b>
P2CFGB<x>/P2CFGA<x> = 00		MODE 0 Open Drain.								
P2CFGB<x>/P2CFGA<x> = 01		MODE 1 Quasi Bi-Directional.								
P2CFGB<x>/P2CFGA<x> = 10		MODE2 High Impedance.								
P2CFGB<x>/P2CFGA<x> = 11		MODE3 Push Pull.								
<b>P3CFGA</b>	BEH	Reserved	Reserved	Reserved	Reserved	P3CFGA<3>	P3CFGA<2>	P3CFGA<1>	P3CFGA<0>	<b>FFH</b>
<b>P3CFGB</b>	BFH	Reserved	Reserved	Reserved	Reserved	P3CFGB<3>	P3CFGB<2>	P3CFGB<1>	P3CFGB<0>	<b>00H</b>
P3CFGB<x>/P3CFGA<x> = 00		MODE 0 Open Drain.								
P3CFGB<x>/P3CFGA<x> = 01		MODE 1 Quasi Bi-directional.								
P3CFGB<x>/P3CFGA<x> = 10		MODE2 High Impedance.								
P3CFGB<x>/P3CFGA<x> = 11		MODE3 Push Pull.								
<b>PCON</b>	87H	SMOD	ARD	RFI	WLE	GF1	GF0	PD	IDL	<b>00H</b>
SMOD	UART Baud Rate Double Control.									
ARD	Auxiliary RAM Disable, All MOVX instructions access the external data memory.									
RFI	Disable ALE during internal access to reduce Radio Frequency Interference.									
WLE	Watch Dog Timer enable.									
GF1	General purpose flag.									
GF0	General purpose flag.									
PD	Power-down activation bit.									
IDL	Idle mode activation bit.									
<b>PSW</b>	D0H	C	AC	F0	RS<1>	RS<0>	OV	-	P	<b>00H</b>
C	Carry Bit.									
AC	Auxiliary Carry bit.									
F0	Flag 0, General purpose flag.									
RS<1:0>	Register Bank selector bits. RS<1:0> = 00, Bank0 (00H - 07H). RS<1:0> = 01, Bank1 (08H - 0FH). RS<1:0> = 10, Bank2 (10H - 17H). RS<1:0> = 11, Bank3 (18H - 1FH).									
OV	Overflow flag.									

**Table 3** SFR Bit description

TV signal processor-Teletext decoder with  
embedded  $\mu$ -Controller

## TDA935X/6X/8X PS/N2 series

Names	ADD	BIT7	BIT6	BIT5	BIT4	BIT3	BIT2	BIT1	BIT0	RESET
P	Parity bit.									
<b>PWM0</b>	D5H	PW0E	1	PW0V<5>	PW0V<4>	PW0V<3>	PW0V<2>	PW0V<1>	PW0V<0>	<b>40H</b>
PW0E	0 - Disable Pulse Width Modulator 0. 1 - Enable Pulse Width Modulator 0.									
PW0V<5:0>	Pulse Width Modulator high time.									
<b>PWM1</b>	D6H	PW1E	1	PW1V<5>	PW1V<4>	PW1V<3>	PW1V<2>	PW1V<1>	PW1V<0>	<b>40H</b>
PW1E	0 - Disable Pulse Width Modulator 1. 1 - Enable Pulse Width Modulator 1.									
PW1V<5:0>	Pulse Width Modulator high time.									
<b>PWM2</b>	E4H	PW2E	1	PW2V<5>	PW2V<4>	PW2V<3>	PW2V<2>	PW2V<1>	PW2V<0>	<b>40H</b>
PW2E	0 - Disable Pulse Width Modulator 2. 1 - Enable Pulse Width Modulator 2.									
PW2V<5:0>	Pulse Width Modulator high time.									
<b>PWM3</b>	DCH	PW3E	1	PW3V<5>	PW3V<4>	PW3V<3>	PW3V<2>	PW3V<1>	PW3V<0>	<b>40H</b>
PW3E	0 - Disable Pulse Width Modulator 3. 1 - Enable Pulse Width Modulator 3.									
PW3V<5:0>	Pulse Width Modulator high time.									
<b>ROMBK</b>	FBH	STANDBY	IIC_LUT<1>	IIC_LUT<0>	0	0	0	ROMBK<1>	ROMBK<0>	<b>00H</b>
STANDBY	0 - Disable Stand-by Mode 1 - Enable Stand-by Mode									
IIC_LUT<1:0>	IIC Lookup table selection: IIC_LUT<1:0>=00, 558 Normal Mode. IIC_LUT<1:0>=01, 558 Fast Mode. IIC_LUT<1:0>=10, 558 Slow Mode. IIC_LUT<1:0>=11, Reserved.									
ROMBK<1:0>	ROM Bank selection ROMBK<1:0>=00, Bank0 ROMBK<1:0>=01, Bank1 ROMBK<1:0>=10, Bank2 ROMBK<1:0>=11, Reserved									
<b>SIADR</b>	DBH	ADR<6>	ADR<5>	ADR<4>	ADR<3>	ADR<2>	ADR<1>	ADR<0>	GC	<b>00H</b>
ADR<6:0>	I2C Slave Address.									
GC	0 - Disable I <sup>2</sup> C general call address. 1 - Enable I <sup>2</sup> C general call address.									
<b>SICON</b>	D8H	CR<2>	ENSI	STA	STO	SI	AA	CR<1>	CR<0>	<b>00H</b>
CR<2:0>	Clock rate bits. IIC rates are selectable (three tables)									
ENSI	0 - Disable I <sup>2</sup> C interface. 1 - Enable I <sup>2</sup> C interface.									



**Table 3** SFR Bit description

# TV signal processor-Teletext decoder with embedded $\mu$ -Controller TDA935X/6X/8X PS/N2 series

Names	ADD	BIT7	BIT6	BIT5	BIT4	BIT3	BIT2	BIT1	BIT0	RESET
STA	START flag. When this bit is set in slave mode, the hardware checks the I2C bus and generates a START condition if the bus is free or after the bus becomes free. If the device operates in master mode it will generate a repeated START condition.									
STO	STOP flag. If this bit is set in a master mode a STOP condition is generated. A STOP condition detected on the I2C bus clears this bit. This bit may also be set in slave mode in order to recover from an error condition. In this case no STOP condition is generated to the I2C bus, but the hardware releases the SDA and SCL lines and switches to the not selected receiver mode. The STOP flag is cleared by the hardware.									
SI	Serial Interrupt flag. This flag is set and an interrupt request is generated, after any of the following events occur: -A START condition is generated in master mode. -The own slave address has been received during AA=1. -The general call address has been received while S1ADR.GC and AA=1. -A data byte has been received or transmitted in master mode (even if arbitration is lost). -A data byte has been received or transmitted as selected slave. A STOP or START condition is received as selected slave receiver or transmitter While the SI flag is set, SCL remains LOW and the serial transfer is suspended.SI must be reset by software.									
AA	Assert Acknowledge flag. When this bit is set, an acknowledge is returned after any one of the following conditions -Own slave address is received. -General call address is received(S1ADR.GC=1). -A data byte is received, while the device is programmed to be a master receiver. -A data byte is received, while the device is selected slave receiver. When the bit is reset, no acknowledge is returned. Consequently, no interrupt is requested when the own address or general call address is received.									
<b>SIDAT</b>	DAH	DAT<7>	DAT<6>	DAT<5>	DAT<4>	DAT<3>	DAT<2>	DAT<1>	DAT<0>	<b>00H</b>
DAT<7:0>	I <sup>2</sup> C Data.									
<b>SISTA</b>	D9H	STAT<4>	STAT<3>	STAT<2>	STAT<1>	STAT<0>	0	0	0	<b>F8H</b>
STAT<4:0>	I <sup>2</sup> C Interface Status.									
<b>SAD</b>	E8H	VHI	CH<1>	CH<0>	ST	SAD<7>	SAD<6>	SAD<5>	SAD<4>	<b>00H</b>
VHI	0 - Analogue input voltage less than or equal to DAC voltage. 1 - Analogue input voltage greater then DAC voltage.									
CH<1:0>	ADC Input channel select. CH<1:0> = 00,ADC3. CH<1:0> = 01,ADC0. CH<1:0> = 10,ADC1. CH<1:0> = 11,ADC2.									
ST	Initiate voltage comparison between ADC input Channel and SADB<3:0> value. Note: Set by Software and reset by Hardware.									
SAD<7:4>	Most Significant nibble of DAC input word									
<b>SADB</b>	98H	0	0	0	DC_COMP	SAD<3>	SAD<2>	SAD<1>	SAD<0>	<b>00H</b>
DC_COMP	0 - Disable DC Comparator mode. 1 - Enable DC Comparator mode.									
SAD<3:0>	4-bit SAD value.									
<b>SP</b>	81H	SP<7>	SP<6>	SP<5>	SP<4>	SP<3>	SP<2>	SP<1>	SP<0>	<b>07H</b>
SP<7>	Stack Pointer.									
<b>TCON</b>	88H	TF1	TR1	TF0	TR0	IE1	IT1	IE0	IT0	<b>00H</b>
TF1	Timer 1 overflow Flag. Set by hardware on Timer/Counter overflow.Cleared by hardware when processor vectors to interrupt routine.									

**Table 3** SFR Bit description

# TV signal processor-Teletext decoder with embedded $\mu$ -Controller TDA935X/6X/8X PS/N2 series

Names	ADD	BIT7	BIT6	BIT5	BIT4	BIT3	BIT2	BIT1	BIT0	RESET
TR1	Timer 1 Run control bit. Set/Cleared by software to turn Timer/Counter on/off.									
TF0	Timer 0 overflow Flag. Set by hardware on Timer/Counter overflow.Cleared by hardware when processor vectors to interrupt routine.									
TR0	Timer 0 Run control bit. Set/Cleared by software to turn Timer/Counter on/off.									
IE1	Interrupt 1 Edge flag (both edges generate flag). Set by hardware when external interrupt edge detected.Cleared by hardware when interrupt processed.									
IT1	Interrupt 1 Type control bit. Set/Cleared by Software to specify edge/low level triggered external interrupts.									
IE0	Interrupt 0 Edge 1 flag. Set by hardware when external interrupt edge detected.Cleared by hardware when interrupt processed.									
IT0	Interrupt 0 Type flag.Set/Cleared by Software to specify falling edge/low level triggered external interrupts.									
<b>TDACH</b>	D3H	TPWE	1	TD<13>	TD<12>	TD<11>	TD<10>	TD<9>	TD<8>	<b>40H</b>
TPWE	0 - Disable Tuning Pulse Width Modulator. 1 - Enable Tuning Pulse Width Modulator.									
TD<13:8>	Tuning Pulse Width Modulator High Byte.									
<b>TDACL</b>	D2H	TD<7>	TD<6>	TD<5>	TD<4>	TD<3>	TD<2>	TD<1>	TD<0>	<b>00H</b>
TD<7:0>	Tuning Pulse Width Modulator Low Byte.									
<b>TH0</b>	8CH	TH0<7>	TH0<6>	TH0<5>	TH0<4>	TH0<3>	TH0<2>	TH0<1>	TH0<0>	<b>00H</b>
TH0<7:0>	Timer 0 high byte.									
<b>TH1</b>	8DH	TH1<7>	TH1<6>	TH1<5>	TH1<4>	TH1<3>	TH1<2>	TH1<1>	TH1<0>	<b>00H</b>
TH1<7:0>	Timer 1 high byte.									
<b>TL0</b>	8AH	TL0<7>	TL0<6>	TL0<5>	TL0<4>	TL0<3>	TL0<2>	TL0<1>	TL0<0>	<b>00H</b>
TL0<7:0>	Timer 0 low byte.									
<b>TL1</b>	8BH	TL1<7>	TL1<6>	TL1<5>	TL1<4>	TL1<3>	TL1<2>	TL1<1>	TL1<0>	<b>00H</b>
TL1<7:0>	Timer 1 low byte.									
<b>TMOD</b>	89H	GATE	C/T	M1	M0	GATE	C/T	M1	M0	<b>00H</b>
<div style="display: flex; justify-content: space-around; align-items: center;"> <div style="text-align: center;">  <p>Timer / Counter 1</p> </div> <div style="text-align: center;">  <p>Timer / Counter 0</p> </div> </div>										
GATE	Gating Control Timer /Counter 1.									
C/T	Counter/Timer 1 selector.									
M1,M0	Mode control bits Timer/Counter 1. M1,M0 = 00, 8 bit timer or 8 bit counter with divide by 32 pre-scaler. M1,M0 = 01, 16 bit time interval or event counter. M1,M0 = 10, 8 bit time interval or event counter with automatic reload upon overflow. Reload value stored in TH1. M1,M0 = 11, stopped.									
GATE	Gating control Timer/Counter 0.									
C/T	Counter/Timer 0 selector.									

**Table 3** SFR Bit description

# TV signal processor-Teletext decoder with embedded $\mu$ -Controller TDA935X/6X/8X PS/N2 series

Names	ADD	BIT7	BIT6	BIT5	BIT4	BIT3	BIT2	BIT1	BIT0	RESET
M1,M0	Mode Control bits Timer/Counter 0. M1,M0 = 00, 8 bit timer or 8 bit counter with divide by 32 pre-scaler. M1,M0 = 01, 16 bit time interval or event counter. M1,M0 = 10, 8 bit time interval or event counter with automatic reload upon overflow. Reload value stored in TH0. M1,M0 = 11, one 8 bit time interval or event counter and one 8 bit time interval counter.									
<b>TP2CL</b>	9CH	TP2CL<7>	TP2CL<6>	TP2CL<5>	TP2CL<4>	TP2CL<3>	TP2CL<2>	TP2CL<1>	TP2CL<0>	<b>00H</b>
TP2CL<7:0>	Indicate the low byte of the Time 2 current value.									
<b>TP2CH</b>	9DH	TP2CH<7>	TP2CH<6>	TP2CH<5>	TP2CH<4>	TP2CH<3>	TP2CH<2>	TP2CH<1>	TP2CH<0>	<b>00H</b>
TP2CH<7:0>	Indicate the high byte of the Time 2 current value.									
<b>TP2H</b>	92H	TP2H<7>	TP2H<6>	TP2H<5>	TP2H<4>	TP2H<3>	TP2H<2>	TP2H<1>	TP2H<0>	<b>00H</b>
TP2H<7:0>	Timer 2 high byte, never change unless updated by the software.									
<b>TP2L</b>	91H	TP2L<7>	TP2L<6>	TP2L<5>	TP2L<4>	TP2L<3>	TP2L<2>	TP2L<1>	TP2L<0>	<b>00H</b>
TP2L<7:0>	Timer 2 low byte, never change unless updated by the software.									
<b>TP2PR</b>	93H	TP2PR<7>	TP2PR<6>	TP2PR<5>	TP2PR<4>	TP2PR<3>	TP2PR<2>	TP2PR<1>	TP2PR<0>	<b>00H</b>
TP2H<7:0>	Timer 2 Pre-scaler, never change unless updated by the software.									
<b>TP2CRL</b>	94H	-	-	-	-	-	-	TP2CRL<1>	TP2CRL<0>	<b>00H</b>
TP2CRL<0>	Timer 2 Control. 0 - Timer 2 disabled. 1 - Timer 2 enabled.									
TP2CRL<1>	Timer 2 Status. 0 - No Overflow. 1 - Overflow.									
<b>TEST</b>	FDH	TEST<7>	TEST<6>	TEST<5>	TEST<4>	TEST<3>	TEST<2>	TEST<1>	TEST<0>	<b>00H</b>
TEST<2:0>	Program Type bit SEL<2:0>. 011 - Display Dram test. 001 - Acquisition1 test. 010 - Acquisition2 test									
TEST<4:3>	Functional test mode bits, set via mode select logic.									
TEST<7:5>	Dram Size. 000 - 1.5K x 16. 001 - 2K x 16. 010 - 6K x 16. 011 - 7K x 16. 100 - 12K x 16. 101 - 14K x 16. 110 - 1K x 16. 111 - 11K x 16.									
<b>TXT0</b>	C0H	X24 POSN	DISPLAY X24	AUTO FRAME	DISABLE HEADER ROLL	DISPLAY STATUS ROW ONLY	DISABLE FRAME	VPS ON	INV ON	<b>00H</b>
X24 POSN	0 - Store X/24 in extension memory 1 - Store X/24 in basic page memory with packets 0 to 23									

**Table 3** SFR Bit description

TV signal processor-Teletext decoder with  
embedded  $\mu$ -Controller

## TDA935X/6X/8X PS/N2 series

Names	ADD	BIT7	BIT6	BIT5	BIT4	BIT3	BIT2	BIT1	BIT0	RESET
DISLAY X24	0 - Display row 24 from basic page memory 1 - Display row 24 from appropriate location in extension memory									
AUTO FRAME	0 - Normal Frame output 1 - Frame output is switched off automatically if any video displayed									
DISABLE HEADER ROLL	0 - Write rolling headers and time to current display page 1 - Disable writing of rolling headers and time to into memory									
DISPLAY STATUS ROW ONLY	0 - Display normal page rows 0 to 24 1 - Display only row 24									
DISABLE FRAME	0 - Normal Frame output 1 - Force Frame output to be low (0)									
VPS ON	0 - VPS acquisition off 1 - VPS acquisition on									
INV ON	0 - Inventory page off 1 - Inventory page on									
<b>TXT1</b>	C1H	EXT PKT OFF	8 BIT	ACQ OFF	ACQ OFF	FULL FIELD	FIELD POLARITY	H POLARITY	V POLARITY	<b>00H</b>
EXT PKT OFF	0 - Acquire extension packets X/24,X/27,8/30/X 1 - Disable acquisition of extension packets									
8 BIT	0 - Error check and/or correct packets 0 to 24 1 - Disable checking of packets 0 to 24 written into memory									
ACQ OFF	0 - Write requested data into display memory 1 - Disable writing of data into Display memory									
X26 OFF	0 - Enable automatic processing of X/26 data 1 - Disable automatic processing of X/26 data									
FULL FIELD	0 - Acquire CC data only on selected line. 1 - Acquire CC data on any TV line (for test purposes).									
FIELD POLARITY	0 - Vsync pulse in first half of line during even field. 1 - Vsync pulse in second half of line during even field.									
H POLARITY	0 - Hsync reference edge is positive going 1 - Hsync reference edge is negative going									
V POLARITY	0 - Vsync reference edge is positive going 1 - Vsync reference edge is negative going									
<b>TXT2</b>	C2H	ACQ BANK	REQ<3>	REQ<2>	REQ<1>	REQ<0>	SC<2>	SC<1>	SC<0>	<b>00H</b>
ACQ_BANK	0 - Select Acquisition bank 0 1 - Select Acquisition bank 1									
REQ<3:0>	Page request									
SC<2:0>	Start column of page request									
<b>TXT3</b>	C3H				PRD<4>	PRD<3>	PRD<2>	PRD<1>	PRD<0>	<b>00H</b>
PRD<4:0>	Page Request data									

**Table 3** SFR Bit description

# TV signal processor-Teletext decoder with embedded $\mu$ -Controller TDA935X/6X/8X PS/N2 series

Names	ADD	BIT7	BIT6	BIT5	BIT4	BIT3	BIT2	BIT1	BIT0	RESET
<b>TXT4</b>	C4H	OSD BANK ENABLE	QUAD WIDTH ENABLE	EAST/WEST	DISABLE DBL HEIGHT	B MESH ENABLE	C MESH ENABLE	TRANS ENABLE	SHADOW ENABLE	<b>00H</b>
OSD BANK ENABLE	0 - Only alpha numeric OSD characters available, 32 locations 1 - Alternate OSD location available via graphic attribute, additional 32 location									
QUAD WIDTH ENABLE	0 - Disable display of Quadruple width characters 1 - Enable display of Quadruple width characters									
EAST/WEST	0 - Western language selection of character codes A0 to FF 1 - Eastern character selection of character codes A0 to FF									
DISABLE DOUBLE HEIGHT	0 - Allow normal decoding of double height characters 1 - Disable normal decoding of double height characters									
B MESH ENABLE	0 - Normal display of black background 1 - Enable meshing of black background									
C MESH ENABLE	0 - normal display of coloured background 1 - Enable meshing of coloured background									
TRANS ENABLE	0 - Display black background as normal 1 - Display black background as video									
SHADOW ENABLE	0 - Disable display of shadow/fringing 1 - Display shadow/ fringe (default SE black)									
<b>TXT5</b>	C5H	BKGND OUT	BKGND IN	COR OUT	COR IN	TEXT OUT	TEXT IN	PICTURE ON OUT	PICTURE ON IN	<b>03H</b>
BKGND OUT	0 - Background colour not displayed outside teletext boxes 1 - Background colour displayed outside teletext boxes									
BKGND IN	0 - Background colour not displayed inside teletext boxes 1 - Background colour displayed inside teletext boxes									
COR OUT	0 - COR not active outside teletext and OSD boxes 1 - COR active outside teletext and OSD boxes									
COR IN	0 - COR not active inside teletext and OSD boxes 1 - COR active inside teletext and OSD boxes									
TEXT OUT	0 - TEXT not displayed outside teletext boxes 1 - TEXT displayed outside teletext boxes									
TEXT IN	0 - TEXT not displayed inside teletext boxes 1 - TEXT displayed inside teletext boxes									
PICTURE ON OUT	0 - VIDEO not displayed outside teletext boxes 1 - VIDEO displayed outside teletext boxes									
PICTURE ON IN	0 - VIDEO not displayed inside teletext boxes 1 - VIDEO displayed inside teletext boxes									
<b>TXT6</b>	C6H	BKGND OUT	BKGND IN	COR OUT	COR IN	TEXT OUT	TEXT IN	PICTURE ON OUT	PICTURE ON IN	<b>03H</b>
BKGND OUT	0 - Background colour not displayed outside teletext boxes 1 - Background colour displayed outside teletext boxes									

**Table 3** SFR Bit description

TV signal processor-Teletext decoder with  
embedded  $\mu$ -Controller

## TDA935X/6X/8X PS/N2 series

Names	ADD	BIT7	BIT6	BIT5	BIT4	BIT3	BIT2	BIT1	BIT0	RESET
BKGND IN	0 - Background colour not displayed inside teletext boxes 1 - Background colour displayed inside teletext boxes									
COR OUT	0 - COR not active outside teletext and OSD boxes 1 - COR active outside teletext and OSD boxes									
COR IN	0 - COR not active inside teletext and OSD boxes 1 - COR active inside teletext and OSD boxes									
TEXT OUT	0 - TEXT not displayed outside teletext boxes 1 - TEXT displayed outside teletext boxes									
TEXT IN	0 - TEXT not displayed inside teletext boxes 1 - TEXT displayed inside teletext boxes									
PICTURE ON OUT	0 - VIDEO not displayed outside teletext boxes 1 - VIDEO displayed outside teletext boxes									
PICTURE ON IN	0 - VIDEO not displayed inside teletext boxes 1 - VIDEO displayed inside teletext boxes									
<b>TXT7</b>	C7H	STATUS ROW TOP	CURSOR ON	REVEAL	BOTTOM/TOP	DOUBLE HEIGHT	BOX ON 24	BOX ON 1-23	BOX ON 0	<b>00H</b>
STATUS ROW TOP	0 - Display memory row 24 information below teletext page (on display row 24) 1 - Display memory row 24 information above teletext page (on display row 0)									
CURSOR ON	0 - Disable display of cursor 1 - Display cursor at position given by TXT9 and TXT10									
REVEAL	0 - Display as spaces characters in area with conceal attribute set 1 - Display characters in area with conceal attribute set									
BOTTOM/TOP	0 - Display memory rows 0 to 11 when double height bit is set 1 - Display memory rows 12 to 23 when double height bit is set									
DOUBLE HEIGHT	0 - Display each characters with normal height 1 - Display each character as twice normal height.									
BOX ON 24	0 - Disable display of teletext boxes in memory row 24 1 - Enable display of teletext boxes in memory row 24									
BOX ON 1-23	0 - Disable display of teletext boxes in memory row 1 to 23 1 - Enable display of teletext boxes in memory row 1 to 23									
BOX ON 0	0 - Disable display of teletext boxes in memory row 0 1 - Enable display of teletext boxes in memory row 0									
<b>TXT8</b>	C8H	(Reserved) 0	FLICKER STOP ON	HUNT	DISABLE SPANISH	PKT 26 RECEIVED	WSS RECEIVED	WSS ON	(Reserved) 0	<b>00H</b>
FLICKER STOP ON	0 - Enable 'Flicker Stopper' circuitry 1 - Disable 'Flicker Stopper' circuitry									
HUNT	0 - Allow automatic hunting for amplitude of data to be acquired 1 - Disable automatic hunting for amplitude									
DISABLE SPANISH	0 - Enable special treatment of Spanish packet 26 characters 1 - Disable special treatment of Spanish packet 26 characters									

Table 3 SFR Bit description



# TV signal processor-Teletext decoder with embedded $\mu$ -Controller TDA935X/6X/8X PS/N2 series

Names	ADD	BIT7	BIT6	BIT5	BIT4	BIT3	BIT2	BIT1	BIT0	RESET
PKT 26 RECEIVED	0 - No packet 26 data has been processed 1 - Packet 26 data has been processed. Note: This flag is set by Hardware and must be reset by Software									
WSS RECEIVED	0 - No Wide Screen Signalling data has been processed 1 - Wide Screen signalling data has been processed Note: This flag is set by Hardware and must be reset by Software.									
WSS ON	0 - Disable acquisition of WSS data. 1 - Enable acquisition of WSS data.									
<b>TXT9</b>	C9H	CURSOR FREEZE	CLEAR MEMORY	A0	R<4>	R<3>	R<2>	R<1>	R<0>	<b>00H</b>
CURSOR FREEZE	0 - Use current TXT9 and TXT10 values for cursor position. 1 - Lock cursor at current position									
CLEAR MEMORY	0 - 1 - Clear memory block pointed to by TXT15 Note: This flag is set by Software and reset by Hardware									
A0	0 - Access memory block pointed to by TXT15 1 - Access extension packet memory									
R<4:0>	Current memory ROW value. Note: Valid range TXT mode 0 to 24, CC mode 0 to 15									
<b>TXT10</b>	CAH	0	0	C<5>	C<4>	C<3>	C<2>	C<1>	C<0>	<b>00H</b>
C<5:0>	Current memory COLUMN value. Note: Valid range TXT mode 0 to 39, CC mode 0 to 47									
<b>TXT11</b>	CBH	D<7>	D<6>	D<5>	D<4>	D<3>	D<2>	D<1>	D<0>	<b>00H</b>
D<7:0>	Data value written or read from memory location defined by TXT9, TXT10 and TXT15									
<b>TXT12</b>	CCH	625/525 SYNC	ROM VER<4>	ROM VER<3>	ROM VER<2>	ROM VER<1>	ROM VER<0>	1	VIDEO SIGNAL QUALITY	<b>xxxxx x1xB</b>
625/525 SYNC	0 - 625 line CVBS signal is being received 1 - 525 line CVBS signal is being received									
ROM VER<4:0>	Mask programmable identification for character set Rom Version <4> : 0 - Spanish Flicker Stopper Disabled. 1 - Spanish Flicker Stopper Enabled (Controlled by TXT8 Bit-6).									
1	Reserved									
VIDEO SIGNAL QUALITY	0 - Acquisition can not be synchronised to CVBS input. 1 - Acquisition can be synchronised to CVBS									
<b>TXT13</b>	F8H	VPS RECEIVED	PAGE CLEARING	525 DISPLAY	525 TEXT	625 TEXT	PKT 8/30	FASTEXT	0	<b>xxxxx xx0B</b>
VPS RECEIVED	0 - 1 - VPS data									
PAGE CLEARING	0 - No page clearing active 1 - Software or Power On page clear in progress									

**Table 3** SFR Bit description

TV signal processor-Teletext decoder with  
embedded  $\mu$ -Controller

## TDA935X/6X/8X PS/N2 series

Names	ADD	BIT7	BIT6	BIT5	BIT4	BIT3	BIT2	BIT1	BIT0	RESET
525 DISPLAY	0 - 625 Line synchronisation for Display. 1 - 525 Line synchronisation for Display.									
525 TEXT	0 - 525 Line WST not being received 1 - 525 line WST being received									
625 TEXT	0 - 625 Line WST not being received 1 - 625 line WST being received									
PKT 8/30	0 - No Packet 8/30/x(625) or Packet 4/30/x(525) data detected 1 - Packet 8/30/x(625) or Packet 4/30/x(525) data detected									
FASTTEXT	0 - No Packet x/27 data detected 1 - Packet x/27 data detected									
0	Reserved									
<b>TXT14</b>	CDH	0	0	0	DISPLAY BANK	PAGE<3>	PAGE<2>	PAGE<1>	PAGE<0>	<b>00H</b>
DISPLAY BANK	0 - Select lower bank for Display 1 - Select upper bank for Display									
PAGE<3:0>	Current Display page									
<b>TXT15</b>	CEH	0	0	0	MICRO BANK	BLOCK<3> >	BLOCK<2> >	BLOCK<1> >	BLOCK<0> >	<b>00H</b>
MICRO BANK	0 - Select lower bank for Micro 1 - Select upper bank for Micro									
BLOCK<3:0>	Current Micro block to be accessed by TXT9, TXT10 and TXT11									
<b>TXT17</b>	B9H	0	FORCE ACQ<1>	FORCE ACQ<0>	FORCE DISP<1>	FORCE DISP<0>	SCREEN COL2	SCREEN COL1	SCREEN COL0	<b>00H</b>
FORCE ACQ<1:0>	00 - Automatic Selection 01 - Force 525 timing, Force 525 Teletext Standard 10 - Force 625 timing, Force 625 Teletext Standard 11 - Force 625 timing, Force 525 Teletext Standard									
FORCE DISP<1:0>	00 - Automatic Selection 01 - Force Display to 525 mode (9 lines per row) 10 - Force Display to 625 mode (10 lines per row) 11 - Not Valid (default to 625)									
SCREEN COL<2:0>	Defines colour to be displayed instead of TV picture and black background. The bits <2:0> are equivalent to the RGB components 000 - Transparent 001 - CLUT entry 9 010 - CLUT entry 10 011 - CLUT entry 11 100 - CLUT entry 12 101 - CLUT entry 13 110 - CLUT entry 14 111 - CLUT entry 15									
<b>TXT18</b>	B2H	NOT<3>	NOT<2>	NOT<1>	NOT<0>	0	0	BS<1>	BS<0>	<b>00H</b>
NOT<3:0>	National Option table selection, maximum of 32 when used with East/West bit									
BS<1:0>	Basic Character set selection									

**Table 3** SFR Bit description

TV signal processor-Teletext decoder with  
embedded  $\mu$ -Controller

## TDA935X/6X/8X PS/N2 series

Names	ADD	BIT7	BIT6	BIT5	BIT4	BIT3	BIT2	BIT1	BIT0	RESET
<b>TXT19</b>	B3H	TEN	TC<2>	TC<1>	TC<0>	0	0	TS<1>	TS<0>	<b>00H</b>
TEN	0 - Disable Twist function 1 - Enable Twist character set									
TC<2:0>	Language control bits (C12/C13/C14) that has Twisted character set									
TS<1:0>	Twist Character set selection									
<b>TXT20</b>	B4H	DRCS ENABLE	OSD PLANES	0	0	OSD LANG ENABLE	OSD LAN<2>	OSD LAN<1>	OSD LAN<0>	<b>00H</b>
DRCS ENABLE	0 - Normal OSD characters used 1 - Re-map column 9 to DRCS (TXT and CC modes),									
OSD PLANES	0 - Character code columns 8 and 9 defined as single plane characters 1 - Character code columns 8 and 9 defined as double plane characters									
OSD LANG ENABLE	Enable use of OSD LAN<2:0> to define language option for display, instead of C12/C13/C14									
OSD LAN<2:0>	Alternative C12/C13/C14 bits for use with OSD menus									
<b>TXT21</b>	B5H	DISP LINES<1>	DISP LINES<0>	CHAR SIZE<1>	CHAR SIZE<0>	Reserved	CC ON	I2C PORT0	CC/TXT	<b>02H</b>
DISP LINES<1:0>	The number of display lines per character row. 00 - 10 lines per character (defaults to 9 lines in 525 mode) 01 - 13 lines per character 10 - 16 lines per character 11 - reserved									
CHAR SIZE<1:0>	Character matrix size. 00 - 10 lines per character (matrix 12x10) 01 - 13 lines per character (matrix 12x13) 10 - 16lines per character (matrix 12x16) 11 - reserved									
CCON	0 - Closed Caption acquisition off 1 - Closed Caption acquisition on									
I2C PORT0	0 - Disable I2C PORT0 1 - Enable I2C PORT0 selection (P1.7/SDA0, P1.6/SCL0)									
CC/TXT	0 - Display configured for TXT mode 1 - Display configured for CC mode									
<b>TXT22</b>	B6H	GPF<7>	GPF<6>	GPF<5>	GPF<4>	GPF<3>	GPF<2>	GPF<1>	GPF<0>	<b>XXH</b>
GPF<7:6>	General purpose register, bits defined by mask programmable bits									
GPF<5>	0 - Standard Painter device 1 - Enhanced Painter device									
GPF<4> (Used for software only)	0 - Choose 6 page teletext device 1 - Choose 10 page teletext device									
GPF<3>	0 - PWM0, PWM1, PWM2 & PWM3 output on Port 3.0 to Port 3.3 respectively 1 - PWM0, PWM1, PWM2 & PWM3 output on Port 2.1 to Port 2.4 respectively									

**Table 3** SFR Bit description

# TV signal processor-Teletext decoder with embedded $\mu$ -Controller

## TDA935X/6X/8X PS/N2 series

Names	ADD	BIT7	BIT6	BIT5	BIT4	BIT3	BIT2	BIT1	BIT0	RESET
GPF<2>	0 - Disable Closed Caption acquisition 1 - Enable Closed Caption acquisition									
GPF<1>	0 - Disable Text acquisition 1 - Enable Text acquisition									
GPF<0> (Polarity reversed in Painter1_Plus standalone)	0 - Standalone (Painter1_Plus) mode 1 - UOC mode									
<b>WDT</b>	FFH	WDV<7>	WDV<6>	WDV<5>	WDV<4>	WDV<3>	WDV<2>	WDV<1>	WDV<0>	<b>00H</b>
WDV<7:0>	Watch Dog Timer period									
<b>WDTKEY</b>	FEH	WKEY<7>	WKEY<6>	WKEY<5>	WKEY<4>	WKEY<3>	WKEY<2>	WKEY<1>	WKEY<0>	<b>00H</b>
WKEY<7:0>	Watch Dog Timer Key. Note: Must be set to 55H to disable Watch dog timer when active.									
<b>WSS1</b>	BAH	0	0	0	WSS<3:0> ERROR	WSS<3>	WSS<2>	WSS<1>	WSS<0>	<b>00H</b>
WSS<3:0> ERROR	0 - No error in WSS<3:0> 1 - Error in WSS<3:0>									
WSS<3:0>	Signalling bits to define aspect ratio (group 1)									
<b>WSS2</b>	BBH	0	0	0	WSS<7:4> ERROR	WSS<7>	WSS<6>	WSS<5>	WSS<4>	<b>00H</b>
WSS<7:4> ERROR	0 - No errors in WSS<7:4> 1 - Error in WSS<7:4>									
WSS<7:4>	Signalling bits to define enhanced services (group 2)									
<b>WSS3</b>	BCH	WSS<13:11 < ERROR	WSS<13>	WSS<12>	WSS<11>	WSS<10:8> ERROR	WSS<10>	WSS<9>	WSS<8>	<b>00H</b>
WSS<13:11> ERROR	0 - No error in WSS<13:11> 1 - Error in WSS<13:11>									
WSS<13:11>	Signalling bits to define reserved elements (group 4)									
WSS<10:8> ERROR	0 - No error in WSS<10:8> 1 - Error in WS<10:8>									
WSS<10:8>	Signalling bits to define subtitles (group 3)									
<b>XRAMP</b>	FAH	XRAMP<7>	XRAMP<6>	XRAMP<5>	XRAMP<4>	XRAMP<3>	XRAMP<2>	XRAMP<1>	XRAMP<0>	<b>00H</b>
XRAMP<7:0>	Internal RAM access upper byte address.									

**Table 3** SFR Bit description

# TV signal processor-Teletext decoder with embedded $\mu$ -Controller TDA935X/6X/8X PS/N2 series

## External (Auxiliary + Display) Memory

The normal 80C51 external memory area has been mapped internally to the device, this means that the MOVX instruction accesses data memory internal to the device. The movx memory map is shown in Fig.7.

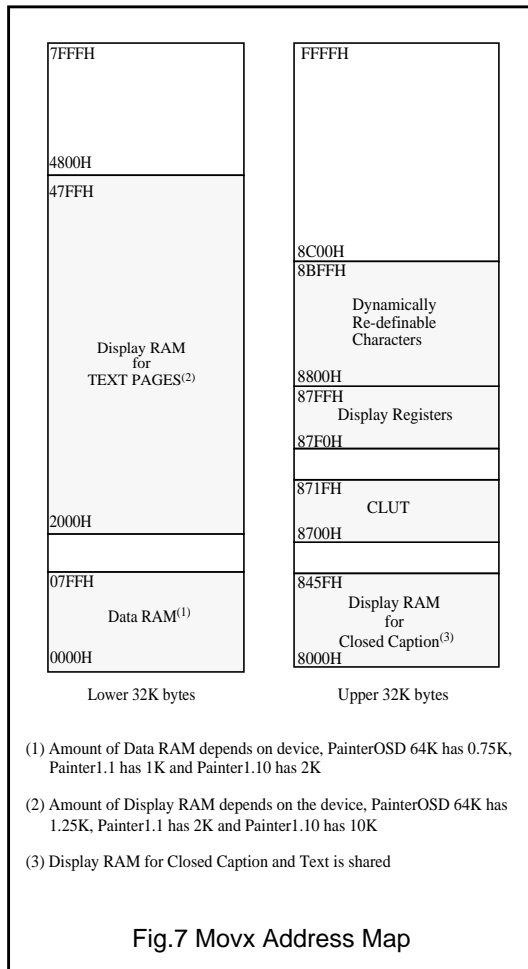

## Auxiliary RAM Page Selection

The Auxiliary RAM page pointer is used to select one of the 256 pages within the auxiliary RAM, not all pages are allocated, refer to Fig.8. A page consists of 256

consecutive bytes. XRAMP only works on internal MOVX memory.

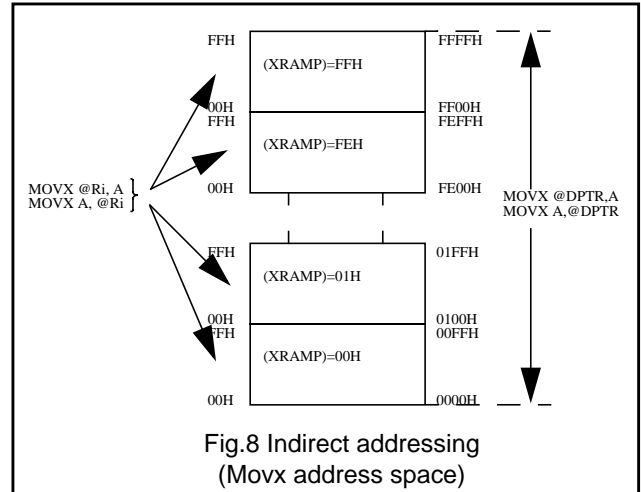

## Power-on Reset

Power on reset is generated internally to the TDA935X/6x/8x device, hence no external reset circuitry is required. The TV processor die shall generate the master reset in the system, which in turn will reset the microcontroller die

An external reset pin is still present and is logically ORed with the internal Power on reset. This pin will only be used for test modes and OTP/ISP programming. The active high reset pin incorporates an internal pull-down, thus it can be left unconnected in application.

## Power Saving modes of Operation

There are three Power Saving modes, Idle, Stand-by and Power Down, incorporated into the Painter1\_Plus die. When utilizing either mode, the 3.3v power to the device (Vddp, Vddc & Vdda) should be maintained, since Power Saving is achieved by clock gating on a section by section basis.

### STAND-BY MODE

During Stand-by mode, the Acquisition and Display sections of the device are disabled. The following functions remain active:-

- 80c51 CPU Core
- Memory Interface
- I2C
- Timer/Counters
- WatchDog Timer
- SAD and PWMs

## TV signal processor-Teletext decoder with embedded $\mu$ -Controller

### TDA935X/6X/8X PS/N2 series

To enter Stand-by mode, the STAND-BY bit in the ROMBANK register must be set. Once in Stand-By, the XTAL oscillator continues to run, but the internal clock to Acquisition and Display are gated out. However, the clocks to the 80c51 CPU Core, Memory Interface, I2C, Timer/Counters, WatchDog Timer and Pulse Width Modulators are maintained. Since the output values on RGB and VDS are maintained the display output must be disabled before entering this mode.

This mode may be used in conjunction with both Idle and Power-Down modes. Hence, prior to entering either Idle or Power-Down, the STAND-BY bit may be set, thus allowing wake-up of the 80c51 CPU core without fully waking the entire device (This enables detection of a Remote Control source in a power saving mode).

#### IDLE MODE

During Idle mode, Acquisition, Display and the CPU sections of the device are disabled. The following functions remain active:-

- Memory Interface
- I2C
- Timer/Counters
- WatchDog Timer
- SAD & PWMs

To enter Idle mode the IDL bit in the PCON register must be set. The WatchDog timer must be disabled prior to entering Idle to prevent the device being reset. Once in Idle mode, the XTAL oscillator continues to run, but the internal clock to the CPU, Acquisition and Display are gated out. However, the clocks to the Memory Interface, I2C, Timer/Counters, WatchDog Timer and Pulse Width Modulators are maintained. The CPU state is frozen along with the status of all SFRs, internal RAM contents are maintained, as are the device output pin values. Since the output values on RGB and VDS are maintained the Display output must be disabled before entering this mode.

There are three methods available to recover from Idle:-

- Assertion of an enabled interrupt will cause the IDL bit to be cleared by hardware, thus terminating Idle mode. The interrupt is serviced, and following the instruction RETI, the next instruction to be executed will be the one after the instruction that put the device into Idle mode.
- A second method of exiting Idle is via an Interrupt generated by the SAD DC Compare circuit. When Painter is configured in this mode, detection of an analogue threshold at the input to the SAD may be used to trigger wake-up of the device i.e. TV Front Panel Key-press. As above, the interrupt is serviced, and following the instruction RETI, the next instruction to be

executed will be the one following the instruction that put the device into Idle.

- The third method of terminating Idle mode is with an external hardware reset. Since the oscillator is running, the hardware reset need only be active for two machine cycles (24 clocks at 12MHz) to complete the reset operation. Reset defines all SFRs and Display memory to a pre-defined state, but maintains all other RAM values. Code execution commences with the Program Counter set to '0000'.

#### POWER DOWN MODE

In Power Down mode the XTAL oscillator still runs, and differential clock transmitter is active. The contents of all SFRs and Data memory are maintained, however, the contents of the Auxiliary/Display memory are lost. The port pins maintain the values defined by their associated SFRs. Since the output values on RGB and VDS are maintained the Display output must be made inactive before entering Power Down mode.

The power down mode is activated by setting the PD bit in the PCON register. It is advised to disable the WatchDog timer prior to entering Power down. Recovery from Power-Down takes several milli-seconds as the oscillator must be given time to stabilise.

There are three methods of exiting power down:-

- An External interrupt provides the first mechanism for waking from Power-Down. Since the clock is stopped, external interrupts needs to be set level sensitive prior to entering Power-Down. The interrupt is serviced, and following the instruction RETI, the next instruction to be executed will be the one after the instruction that put the device into Power-Down mode.
- A second method of exiting Power-Down is via an Interrupt generated by the SAD DC Compare circuit. When Painter is configured in this mode, detection of a certain analogue threshold at the input to the SAD may be used to trigger wake-up of the device i.e. TV Front Panel Key-press. As above, the interrupt is serviced, and following the instruction RETI, the next instruction to be executed will be the one following the instruction that put the device into Power-Down.
- The third method of terminating the Power-Down mode is with an external hardware reset. Reset defines all SFRs and Display memory, but maintains all other RAM values. Code execution commences with the Program Counter set to '0000'.

# TV signal processor-Teletext decoder with embedded $\mu$ -Controller TDA935X/6X/8X PS/N2 series

## I/O Facility

### I/O PORTS

The IC has 13 I/O lines, each is individually addressable, or form part of 4 parallel addressable ports which are port0, port1, port2 and port3.

### PORT TYPE

All individual ports can be programmed to function in one of four modes, the mode is defined by two Port Configuration SFRs. The modes available are Open Drain, Quasi-bidirectional, High Impedance and Push-Pull.

#### Open Drain

The Open drain mode can be used for bi-directional operation of a port. It requires an external pull-up resistor, the pull-up voltage has a maximum value of 5.5V, to allow connection of the device into a 5V environment.

#### Quasi bi-directional

The quasi-bidirectional mode is a combination of open drain and push pull. It requires an external pull-up resistor to VDDp (nominally 3.3V). When a signal transition from 0->1 is output from the device, the pad is put into push-pull mode for one clock cycle (166ns) after which the pad goes into open drain mode. This mode is used to speed up the edges of signal transitions. This is the default mode of operation of the pads after reset.

#### High Impedance

The high impedance mode can be used for Input only operation of the port. When using this configuration the two output transistors are turned off.

#### Push-Pull

The push pull mode can be used for output only. In this mode the signal is driven to either 0V or VDDp, which is nominally 3.3V.

## Interrupt System

The device has 8 interrupt sources, each of which can be enabled or disabled. When enabled, each interrupt can be assigned one of two priority levels. There are four interrupts that are common to the 80C51, two of these are external interrupts (EX0 and EX1) and the other two are timer interrupts (ET0 and ET1). There is also one interrupt (ES2) connected to the 80c51 micro-controller IIC peripheral for Transmit and Receive operation. The TDA935X/6x/8x family of devices have an additional 16-bit Timer (with 8-bit Pre-scaler). To accommodate this, another interrupt ET2PR has been added to indicate timer overflow.

In addition to the conventional 80c51, two application specific interrupts are incorporated internal to the device which have the following functionality:-

**CC (Closed Caption Data Ready Interrupt)** - This interrupt is generated when the device is configured for Closed Caption acquisition. The interrupt is activated at the end of the currently selected Slice Line as defined in the CCLIN SFR.

**BUSY (Display Busy Interrupt)** - An interrupt is generated when the Display enters either a Horizontal or Vertical Blanking Period. i.e. Indicates when the micro-controller can update the Display RAM without causing undesired effects on the screen. This interrupt can be configured in one of two modes using the MMR Configuration Register (Address 87FF, Bit-3 [TXT/V]):-

- TeXT Display Busy: An interrupt is generated on each active horizontal display line when the Horizontal Blanking Period is entered.
- Vertical Display Busy: An interrupt is generated on each vertical display field when the Vertical Blanking Period is entered.

### INTERRUPT ENABLE STRUCTURE

Each of the individual interrupts can be enabled or disabled by setting or clearing the relevant bit in the interrupt enable SFRs (IE and IEN1). All interrupt sources can also be globally disabled by clearing the EA bit (IE.7).

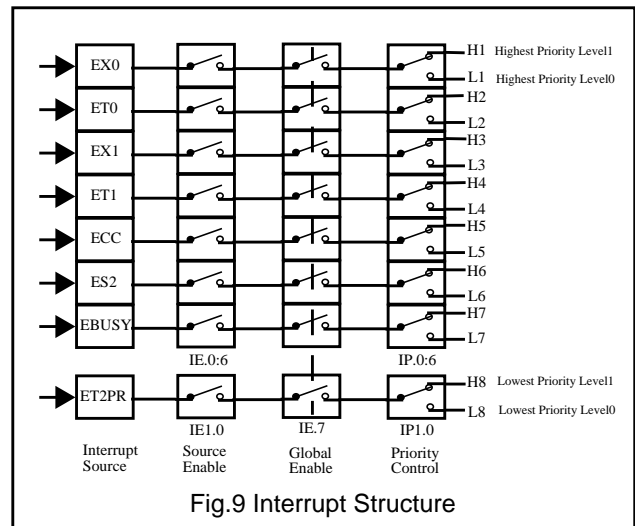

### INTERRUPT ENABLE PRIORITY

Each interrupt source can be assigned one of two priority levels. The interrupt priorities are defined by the interrupt priority SFRs (IP and IP1). A low priority interrupt can be interrupted by a high priority interrupt, but not by another low priority interrupt. A high priority interrupt can not be interrupted by any other interrupt source. If two requests of

# TV signal processor-Teletext decoder with embedded $\mu$ -Controller TDA935X/6X/8X PS/N2 series

different priority level are received simultaneously, the request with the highest priority level is serviced. If requests of the same priority level are received simultaneously, an internal polling sequence determines which request is serviced. Thus, within each priority level there is a second priority structure determined by the polling sequence as defined in Table 4.

Source	Priority within level	Interrupt Vector
EX0	Highest	0003H
ET0		000BH
EX1		0013H
ET1		001BH
ECC		0023H
ES2		002BH
EBUSY		0033H
ET2PR		003BH
	Lowest	

**Table 4** Interrupt Priority (within same level)

**INTERRUPT VECTOR ADDRESS**

The processor acknowledges an interrupt request by executing a hardware generated LCALL to the appropriate servicing routine. The interrupt vector addresses are shown in Table 4.

**LEVEL/EDGE INTERRUPT**

The external interrupt can be programmed to be either level-activated or transition activated by setting or clearing the IT0/1 bits in the Timer Control SFR(TCON).

ITx	Level	Edge
0	Active low	
1		INT0 = Negative Edge INT1 = Positive and Negative Edge

**Table 5** External Interrupt Activation

The external interrupt INT1 differs from the standard 80C51 in that it is activated on both edges when in edge sensitive mode. This is to allow software pulse width measurement for handling remote control inputs.

**Timer/Counter**

Two 16 bit timers/counters are incorporated Timer0 and Timer1. Both can be configured to operate as either timers or event counters.

In Timer mode, the register is incremented on every machine cycle. It is therefore counting machine cycles. Since the machine cycle consists of 12 oscillator periods, the count rate is  $1/12 F_{osc} = 1\text{MHz}$ .

In Counter mode, the register is incremented in response to a negative transition at its corresponding external pin T0/1. Since the pins T0/1 are sampled once per machine cycle it takes two machine cycles to recognise a transition, this gives a maximum count rate of  $1/24 F_{osc} = 0.5\text{MHz}$ . There are six special function registers used to control the timers/counters as defined in Table 6.

SFR	Address
TCON	88H
TMOD	89H
TL0	8AH
TH0	8BH
TL1	8CH
TH1	8DH

**Table 6** Timer/Counter Registers

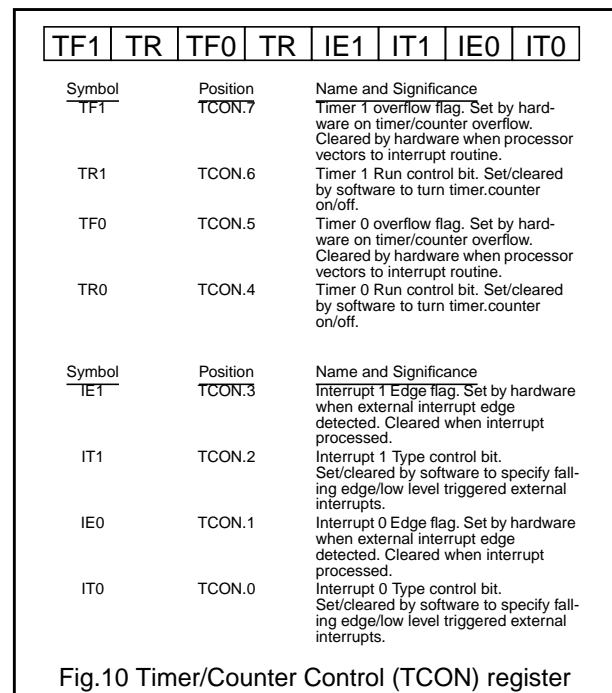



TV signal processor-Teletext decoder with  
embedded  $\mu$ -Controller

## TDA935X/6X/8X PS/N2 series

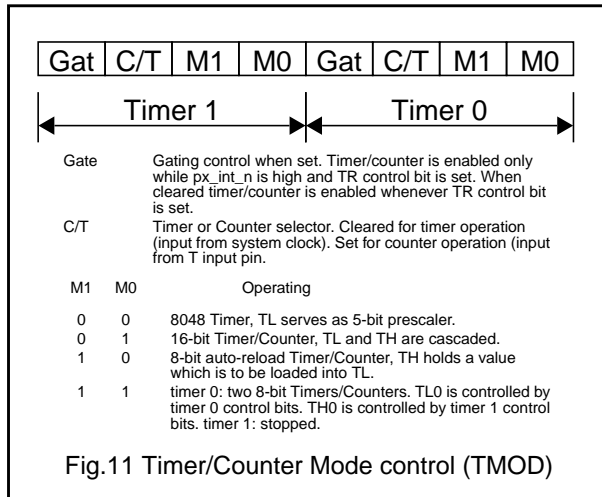

The Timer/Counter function is selected by control bits C/T in the Timer Mode SFR (TMOD). These two Timer/Counter have four operating modes, which are selected by bit-pairs (M1.M0) in the TMOD. Refer to the 80C51 based 8-bit micro-controllers - Philips Semiconductors (ref. IC20) for detail of the modes and operation.

TL0/TL1 and TH0/TH1 are the actual timer/counter registers for timer0 / timer1. TL0/TL1 is the low byte and TH0/TH1 is the high byte.

#### TIMER WITH PRE-SCALER

An additional 16-bit timer with 8-bit pre-scaler is provided to allow timer periods up to 16.777 seconds. This timer remains active during IDLE mode.

TP2L sets the lower value of the period for timer 2 and TP2H is the upper timer value. TP2PR provides an 8-bit pre-scaler for timer 2. The value on TP2PR, TP2H and TP2L shall never change unless updated by the software. If the micro reads TP2R, TP2H or TP2L at any stage, this should return the value written and not the current timer 2 value. The timer 2 should continue after overflow by re-loading the timer with the values of SFRs TP2PR, TP2H and TP2L.

TP2CL and TP2CH indicate the current timer 2 value. These should be readable both when the timer 2 is active and inactive. Once the timer 2 is disable, the timer 2 value at the time of disabling should be maintained on the SFRs TP2CL and TP2CH. At a count of zero (on TP2CL and TP2CH), the overflow flag should be set:- TP2CRL<1> - '0' = no timer 2 overflow, '1'= timer 2 overflow.

TP2CRL is the control and status for timer 2. TP2CRL.0 is the timer enable and TP2CRL.1 is the timer overflow status. The overflow flag will need to be reset by software. Hence, if required, software may poll flag rather than use

interrupt. Upon overflow an interrupt should also be generated.

Reset values of all registers should be 00 hex.

In Timer mode, Timer 2 should count down from the value set on SFRs TP2PR, TP2H and TP2L. It is therefore counting machine cycles. Since the machine cycle consists of 12 oscillator periods, the count rate is  $1/12 f_{osc}$  (1MHz).

$$\text{Timer2 interval} = (\text{TP2H} * 256 + \text{TP2L}) * (\text{TP2PR} + 1) * 1 \text{ us}$$

#### WatchDog Timer

The WatchDog timer is a counter that once in an overflow state forces the micro-controller in to a reset condition. The purpose of the WatchDog timer is to reset the micro-controller if it enters an erroneous processor state (possibly caused by electrical noise or RFI) within a reasonable period of time. When enabled, the WatchDog circuitry will generate a system reset if the user program fails to reload the WatchDog timer within a specified length of time known as the WatchDog interval.

The WatchDog timer consists of an 8-bit counter with an 16-bit pre-scaler. The pre-scaler is fed with a signal whose frequency is  $1/12 f_{osc}$  (1MHz).

The 8 bit timer is incremented every 't' seconds where:

$$t = 12 \times 65536 \times 1 / f_{osc} = 12 \times 65536 \times 1 / 12 \times 10^6 = 65.536 \text{ms}$$

#### WATCHDOG TIMER OPERATION

The WatchDog operation is activated when the WLE bit in the Power Control SFR (PCON) is set. The WatchDog can be disabled by Software by loading the value 55H into the WatchDog Key SFR (WDTKEY). This must be performed before entering Idle/Power Down mode to prevent exiting the mode prematurely.

Once activated the WatchDog timer SFR (WDT) must be reloaded before the timer overflows. The WLE bit must be set to enable loading of the WDT SFR, once loaded the WLE bit is reset by hardware, this is to prevent erroneous Software from loading the WDT SFR.

The value loaded into the WDT defines the WatchDog interval.

$$\text{WatchDog interval} = (256 - \text{WDT}) * t = (256 - \text{WDT}) * 65.536 \text{ms.}$$

The range of intervals is from WDT=00H which gives 16.777s to WDT=FFH which gives 65.536ms.

#### PORT Alternate Functions

The Ports 1,2 and 3 are shared with alternate functions to enable control of external devices and circuitry. The alternate functions are enabled by setting the appropriate

## TV signal processor-Teletext decoder with embedded $\mu$ -Controller

## TDA935X/6X/8X PS/N2 series

SFR and also writing a '1' to the Port bit that the function occupies.

### PWM PULSE WIDTH MODULATORS

The device has four 6-bit Pulse Width Modulated (PWM) outputs for analogue control of e.g. volume, balance, bass and treble. The PWM outputs generate pulse patterns with a repetition rate of 21.33 $\mu$ s, with the high time equal to the PWM SFR value multiplied by 0.33 $\mu$ s. The analogue value is determined by the ratio of the high time to the repetition time, a D.C. voltage proportional to the PWM setting is obtained by means of an external integration network (low pass filter).

#### PWM Control

The relevant PWM is enabled by setting the PWM enable bit PWxE in the PWMx Control register. The high time is defined by the value PWxV<5:0>

### TPWM TUNING PULSE WIDTH MODULATOR

The device has a single 14-bit PWM that can be used for Voltage Synthesis Tuning. The method of operation is similar to the normal PWM except the repetition period is 42.66 $\mu$ s.

#### TPWM Control

Two SFRs are used to control the TPWM, they are TDACL and TDACH. The TPWM is enabled by setting the TPWE bit in the TDACH SFR. The most significant bits TD<13:7> alter the high period between 0 and 42.33 $\mu$ s. The 7 least significant bits TD<6:0> extend certain pulses by a further 0.33 $\mu$ s. e.g. if TD<6:0> = 01H then 1 in 128 periods will be extended by 0.33 $\mu$ s, if TD<6:0>=02H then 2 in 128 periods will be extended.

The TPWM will not start to output a new value until TDACH has been written to. Therefore, if the value is to be changed, TACL should be written before TDACH.

### SAD SOFTWARE A/D

Four successive approximation Analogue to Digital Converters can be implemented in software by making use of the on board 8-bit Digital to Analogue Converter and Analogue Comparator.

#### SAD Control

The control of the required analogue input is done using the channel select bits CH<1:0> in the SAD SFR, this selects the required analogue input to be passed to one of the inputs of the comparator. The second comparator input is generated by the DAC whose value is set by the bits SAD<7:0> in the SAD and SADB SFRs. A comparison between the two inputs is made when the start compare bit ST in the SAD SFR is set, this must be at least one

instruction cycle after the SAD<7:0> value has been set. The result of the comparison is given on VHI one instruction cycle after the setting of ST.

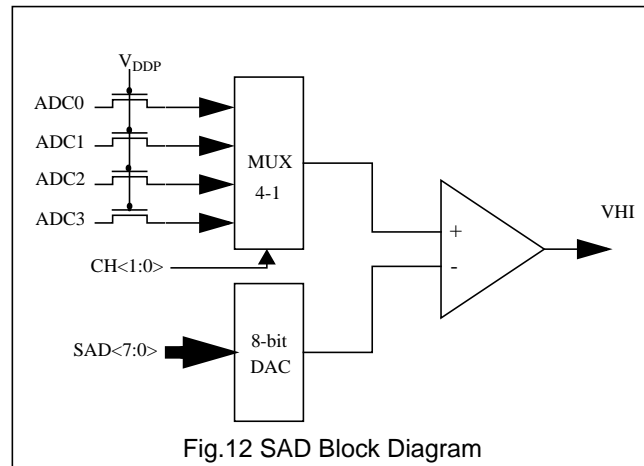

Fig.12 SAD Block Diagram

#### SAD Input Voltage

The external analogue voltage that is used for comparison with the internally generated DAC voltage, does not have the same voltage range due to the 5 V tolerance of the pin. It is limited to  $V_{DDP} - V_{tn}$  where  $V_{tn}$  is a maximum of 0.75 V. For further details refer to the SAA55XX and SAA56XX Software Analogue to Digital Converter Application Note: SPG/AN99022.

#### SAD DC Comparator Mode

The SAD module incorporates a DC Comparator mode which is selected using the 'DC\_COMP' control bit in the SADB SFR. This mode enables the micro-controller to detect a threshold crossing at the input to the selected analogue input pin (P3.0, P3.1, P3.2 or P3.3) of the Software A/D Converter. A level sensitive interrupt is generated when the analogue input voltage level at the pin falls below the analogue output level of the SAD D/A converter.

This mode is intended to provide the device with a wake-up mechanism from Power-Down or Idle when a key-press on the front panel of the TV is detected. The following software sequence should be used when utilizing this mode for Power-Down or Idle:-

1. Disable INT1 using the IE SFR.
2. Set INT1 to level sensitive using the TCON SFR.
3. Set the D/A Converter digital input level to the desired threshold level using the SAD/SADB SFRs and select the required input pin (P3.0, P3.1, P3.2 or P3.3) using CH1, CH0 in the SAD SFR.
4. Enter DC Compare mode by setting the 'DC\_COMP' enable bit in the SADB SFR.

# TV signal processor-Teletext decoder with embedded $\mu$ -Controller

## TDA935X/6X/8X PS/N2 series

5. Enable INT1 using the IE SFR.
6. Enter Power-Down/Idle. Upon wake-up the SAD should be restored to its conventional operating mode by disabling the 'DC\_COMP' control bit.

### I<sup>2</sup>C Serial I/O Bus

The I<sup>2</sup>C bus consists of a serial data line (SDA) and a serial clock line (SCL). The definition of the I<sup>2</sup>C protocol can be found in the 80C51 based 8-bit micro-controllers - Philips Semiconductors (ref. IC20).

The device operates in four modes: -

- Master Transmitter
- Master Receiver
- Slave Transmitter
- Slave Receiver

The micro-controller peripheral is controlled by the Serial Control SFR (S1CON) and its Status is indicated by the status SFR (S1STA). Information is transmitted/received to/from the I<sup>2</sup>C bus using the Data SFR (S1DAT) and the Slave Address SFR (S1ADR) is used to configure the slave address of the peripheral.

The byte level I<sup>2</sup>C serial port is identical to the I<sup>2</sup>C serial port on the 8xC558, except for the clock rate selection bits CR<2:0>. The operation of the subsystem is described in detail in the 8xC558 data sheet and can be found in the 80C51 based 8-bit micro-controllers - Philips Semiconductors (ref. IC20).

Three different IIC selection tables for CR<2:0> can be configured using the ROMBANK SFR (IIC\_LUT<1:0>) as follows: -

#### '558 nominal mode' (iic\_lut="00")

This option accommodates the 558 I<sup>2</sup>C. The various serial rates are shown below: -

CR2	CR1	CR0	f <sub>clk</sub> (6MHz) divided by	I <sup>2</sup> C Bit Frequency (KHz) at f <sub>clk</sub>
0	0	0	60	100
0	0	1	1600	3.75
0	1	0	40	150
0	1	1	30	200
1	0	0	240	25
1	0	1	3200	1.875
1	1	0	160	37.5
1	1	1	120	50

**Table 7** IIC Serial Rates '558 nominal mode'

#### '558 fast mode' (iic\_lut="01")

This option accommodates the 558 I<sup>2</sup>C doubled rates as shown below: -

CR2	CR1	CR0	f <sub>clk</sub> (6MHz) divided by	I <sup>2</sup> C Bit Frequency (KHz) at f <sub>clk</sub>
0	0	0	30	200
0	0	1	800	7.5
0	1	0	20	300
0	1	1	15	400
1	0	0	120	50
1	0	1	1600	3.75
1	1	0	80	75
1	1	1	60	100

**Table 8** IIC Serial Rates '558 fast mode'

#### '558 slow mode' (iic\_lut="10")

This option accommodates the 558 I<sup>2</sup>C rates divided by 2 as shown below: -

CR2	CR1	CR0	f <sub>clk</sub> (6MHz) divided by	I <sup>2</sup> C Bit Frequency (KHz) at f <sub>clk</sub>
0	0	0	120	50
0	0	1	3200	1.875
0	1	0	80	75
0	1	1	60	100
1	0	0	480	12.5
1	0	1	6400	0.9375
1	1	0	320	18.75
1	1	1	240	25

**Table 9** IIC Serial Rates '558 slow mode'

Note: In the above tables the f<sub>clk</sub> relates to the clock rate of the 80c51 IIC module (6MHz).

### I<sup>2</sup>C Port Enable

One external I<sup>2</sup>C port is available. This port is enabled using TXT21.I2C PORT0. Any information transmitted to the device can only be acted upon if the port is enabled. Internal communication between the 80c51 micro-controller and the TV Signal Processor will continue regardless of the value written to TXT21.I2C PORT0.

### LED Support

Port pins P0.5 and P0.6 have a 8mA current sinking capability to enable LEDs in series with current limiting resistors to be driven directly, without the need for additional buffering circuitry.

## TV signal processor-Teletext decoder with embedded $\mu$ -Controller

## TDA935X/6X/8X PS/N2 series

### MEMORY INTERFACE

The memory interface controls the access to the embedded DRAM, refreshing of the DRAM and page clearing. The DRAM is shared between Data Capture, Display and Microcontroller sections. The Data Capture section uses the DRAM to store acquired information that has been requested. The Display reads the DRAM information and converts it to RGB output values. The Microcontroller uses the DRAM as embedded auxiliary RAM.

### DATA CAPTURE

The Data Capture section takes in the analogue Composite Video and Blanking Signal (CVBS) from One Chip, and from this extracts the required data, which is then decoded and stored in SFR memory.

The extraction of the data is performed in the digital domain. The first stage is to convert the analogue CVBS signal into a digital form. This is done using an ADC sampling at 12MHz. The data and clock recovery is then performed by a Multi-Rate Video Input Processor (MulVIP). From the recovered data and clock the following data types are extracted WST Teletext (625/525), Closed Caption, VPS, WSS. The extracted data is stored in either memory (DRAM) via the Memory Interface or in SFR locations.

### Data Capture Features

- Video Signal Quality detector.
- Data Capture for 625 line WST
- Data Capture for 525 line WST
- Data Capture for US Closed Caption
- Data Capture for VPS data (PDC system A)
- Data Capture for Wide Screen Signalling (WSS) bit decoding
- Automatic selection between 525 WST/625WST
- Automatic selection between 625WST/VPS on line 16 of VBI
- Real-time capture and decoding for WST Teletext in Hardware, to enable optimised microprocessor throughput
- Up to 10 pages stored On-Chip
- Inventory of transmitted Teletext pages stored in the Transmitted Page Table (TPT) and Subtitle Page Table (SPT)
- Automatic detection of FASTEXT transmission
- Real-time packet 26 engine in Hardware for processing accented, G2 and G3 characters
- Signal quality detector for WST/VPS data types
- Comprehensive Teletext language coverage
- Full Field and Vertical Blanking Interval (VBI) data capture of WST data

### Analogue to Digital Converter

The CVBS input is passed through a differential to single ended converter (DIVIS), although in this device it is used in single ended configuration with a reference. The analogue output of DIVIS is converted into a digital representation by a full flash ADC with a sampling rate of 12MHz.

### Multi Rate Video Input Processor

The multi rate video input processor is a Digital Signal Processor designed to extract the data and recover the clock from the digital CVBS signal.

## TV signal processor-Teletext decoder with embedded $\mu$ -Controller

## TDA935X/6X/8X PS/N2 series

### Data Standards

The data and clock standards that can be recovered are shown in Table 10 below:-

Data Standard	Clock Rate
625WST	6.9375 MHz
525WST	5.7272 MHz
VPS	5.0 MHz
WSS	5.0 MHz
Closed Caption	500 KHz

**Table 10** Data Slicing Standards

### Data Capture Timing

The Data Capture timing section uses the Synchronisation information extracted from the CVBS signal to generate the required Horizontal and Vertical reference timings. The timing section automatically recognises and selects the appropriate timings for either 625 (50Hz) synchronisation or 525 (60Hz) synchronisation. A flag TXT12.Video Signal Quality is set when the timing section is locked correctly to the incoming CVBS signal. When TXT12.Video Signal Quality is set another flag TXT12.625/525 SYNC can be used to identify the standard.

### Acquisition

The acquisition sections extracts the relevant information from the serial stream of data from the MulVIP and stores it in memory.

#### 625 WST ACQUISITION

The family is capable of acquiring 625-line and 525-line World System Teletext. Teletext pages are identified by seven numbers: magazine (page hundreds), page tens, page units, hours tens, hours units, minutes tens and minutes units. The last four digits, hours and minutes, are known as the subcode, and were originally intended to be time related, hence their names.

#### Making a page request

A page is requested by writing a series of bytes into the TXT3.PRD<4:0> SFR which correspond to the number of the page required. The bytes written into TXT3 are stored in a RAM with an auto-incrementing address. The start address for the RAM is set using the TXT2.SC<2:0> to define which part of the page request is being written, and TXT2.REQ<3:0> is used to define which of the 10 page requests is being modified. If TXT2.REQ<3:0> is greater

than 09h, then data being written to TXT3 is ignored. Table 11 shows the contents of the page request RAM.

Up to 10 pages of teletext can be acquired on the 10 page device, when TXT1.EXT PKT OFF is set to logic 1, and up to 9 pages can be acquired when this bit is set to logic 0. If the 'Do Care' bit for part of the page number is set to 0 then that part of the page number is ignored when the teletext decoder is deciding whether a page being received off air should be stored or not. For example, if the Do Care bits for the 4 subcode digits are all set to 0 then every subcode version of the page will be captured.

Start Column	Byte Identification	PRD<4>	PRD<3>	PRD<2>	PRD<1>	PRD<0>
0	Magazine	DO CARE	HOLD	MAG2	MAG1	MAG0
1	Page Tens	DO CARE	PT3	PT2	PT1	PT0
2	Page Units	DO CARE	PU3	PU2	PU1	PU0
3	Hours Tens	DO CARE	x	x	HT1	HT0
4	Hours Units	DO CARE	HU3	HU2	HU1	HU0
5	Minutes Tens	DO CARE	x	MT2	MT1	MT0
6	Minutes Units	DO CARE	MU3	MU2	MU1	MU0
7	Error Mode	x	x	x	E1	E0

**Table 11** The contents of the Page request RAM

Note: MAG = Magazine PT = Page Tens PU = Page Units HT = Hours Tens HU = Hours Units MT = Minutes Tens MU = Minutes Units E = Error check mode

When the Hold bit is set to 0 the teletext decoder will not recognise any page as having the correct page number and no pages will be captured. In addition to providing the user requested hold function this bit should be used to prevent the inadvertent capture of an unwanted page when a new page request is being made. For example, if the previous page request was for page 100 and this was being changed to page 234, it would be possible to capture page 200 if this arrived after only the requested magazine number had been changed.

The E1 and E0 bits control the error checking which should be carried out on packets 1 to 23 when the page being requested is captured. This is described in more detail in a later section ('Error Checking').

For a multi page device, each packet can only be written into one place in the teletext RAM so if a page matches more than one of the page requests the data is written into the area of memory corresponding to the lowest numbered matching page request.

At power-up each page request defaults to any page, hold on and error check mode 0.

#### Rolling Headers and Time

When a new page has been requested it is conventional for the decoder to turn the header row of the display green

## TV signal processor-Teletext decoder with embedded $\mu$ -Controller

## TDA935X/6X/8X PS/N2 series

and to display each page header as it arrives until the correct page has been found.

When a page request is changed (i.e.: when the TXT3 SFR is written to) a flag (PBLF) is written into bit 5, column 9, row 25 of the corresponding block of the page memory. The state of the flag for each block is updated every TV line, if it is set for the current display block, the acquisition section writes all valid page headers which arrive into the display block and automatically writes an alpha-numeric green character into column 7 of row 0 of the display block every TV line.

When a requested page header is acquired for the first time, rows 1 to 23 of the relevant memory block are cleared to space, i.e.: have 20h written into every column, before the rest of the page arrives. Row 24 is also cleared if the TXT0.X24 POSN bit is set. If the TXT1.EXT PKT OFF bit is set the extension packets corresponding to the page are also cleared.

The last 8 characters of the page header are used to provide a time display and are always extracted from every valid page header as it arrives and written into the display block

The TXT0.DISABLE HEADER ROLL bit prevents any data being written into row 0 of the page memory except when a page is acquired off air i.e.: rolling headers and time are not written into the memory. The TXT1.ACQ OFF bit prevents any data being written into the memory by the teletext acquisition section.

When a parallel magazine mode transmission is being received only headers in the magazine of the page requested are considered valid for the purposes of rolling headers and time. Only one magazine is used even if don't care magazine is requested. When a serial magazine mode transmission is being received all page headers are considered to be valid.

### *Error Checking*

Before teletext packets are written into the page memory they are error checked. The error checking carried out depends on the packet number, the byte number, the error check mode bits in the page request data and the TXT1.8 BIT bit.

If an incorrectable error occurs in one of the Hamming checked addressing and control bytes in the page header or in the Hamming checked bytes in packet 8/30, bit 4 of the byte written into the memory is set, to act as an error flag to the software. If incorrectable errors are detected in any other Hamming checked data the byte is not written into the memory.

### *Teletext Memory Organisation*

The teletext memory is divided into 2 banks of 10 blocks. Normally, when the TXT1.EXT PKT OFF bit is logic 0,

each of blocks 0 to 8 contains a teletext page arranged in the same way as the basic page memory of the page device and block 9 contains extension packets. When the TXT1.EXT PKT OFF bit is logic 1, no extension packets are captured and block 9 of the memory is used to store another page. The number of the memory block into which a page is written corresponds to the page request number which resulted in the capture of the page.

Packet 0, the page header, is split into 2 parts when it is written into the text memory. The first 8 bytes of the header contain control and addressing information. They are Hamming decoded and written into columns 0 to 7 of row 25. Row 25 also contains the magazine number of the acquired page and the PBLF flag but the last 14 bytes are unused and may be used by the software, if necessary.

### *Row 25 Data Contents*

The Hamming error flags are set if the on-board 8/4 Hamming checker detects that there has been an incorrectable (2 bit) error in the associated byte. It is possible for the page to still be acquired if some of the page address information contains incorrectable errors if that part of the page request was a 'don't care'. There is no error flag for the magazine number as an incorrectable error in this information prevents the page being acquired. The interrupted sequence (C9) bit is automatically dealt with by the acquisition section so that rolling headers do not contain a discontinuity in the page number sequence. The magazine serial (C11) bit indicates whether the transmission is a serial or a parallel magazine transmission. This affects the way the acquisition section operates and is dealt with automatically.

The newflash (C5), subtitle (C6), suppress header (C7), inhibit display (C10) and language control (C12 to 14) bits are dealt with automatically by the display section, described below.

The update (C8) bit has no effect on the hardware. The remaining 32 bytes of the page header are parity checked and written into columns 8 to 39 of row 0. Bytes which pass the parity check have the MSB set to 0 and are written into the page memory. Bytes with parity errors are not written into the memory.

### *Inventory Page*

If the TXT0.INV on bit is 1, memory block 8 is used as an inventory page. The inventory page consists of two tables, - the Transmitted Page Table (TPT) and the subtitle page table (SPT).

In each table, every possible combination of the page tens and units digit, 00 to FFh, is represented by a byte. Each bit of these bytes corresponds to a magazine number so each page number, from 100 to 8FF, is represented by a bit in the table. The bit for a particular page in the TPT is set

## TV signal processor-Teletext decoder with embedded $\mu$ -Controller

### TDA935X/6X/8X PS/N2 series

when a page header is received for that page. The bit in the SPT is set when a page header for the page is received which has the 'subtitle' page header control bit (C6) set. The bit for a particular page in the TPT is set when a page header is received for that page. The bit in the SPT is set when a page header for the page is received which has the 'subtitle' page header control bit (C6) set.

#### Packet 26 Processing

One of the uses of packet 26 is to transmit characters which are not in the basic teletext character set. The family automatically decodes packet 26 data and, if a character corresponding to that being transmitted is available in the character set, automatically writes the appropriate character code into the correct location in the teletext memory. This is not a full implementation of the packet 26 specification allowed for in level 2 teletext, and so is often referred to as level 1.5.

By convention, the packets 26 for a page are transmitted before the normal packets. To prevent the default character data over writing the packet 26 data the device incorporates a mechanism which prevents packet 26 data from being overwritten. This mechanism is disabled when the Spanish national option is detected as the Spanish transmission system sends even parity (i.e. incorrect) characters in the basic page locations corresponding to the characters sent via packet 26 and these will not overwrite the packet 26 characters anyway. The special treatment of Spanish national option is prevented if TXT12. ROM VER R4 is logic 0 or if the TXT8.DISABLE SPANISH is set.

Packet 26 data is processed regardless of the TXT1. EXT PKT OFF bit, but setting the TXT1.X26 OFF disables packet 26 processing.

The TXT8. Packet 26 received bit is set by the hardware whenever a character is written into the page memory by the packet 26 decoding hardware. The flag can be reset by writing a 0 into the SFR bit.

#### 525 WST

The 525 line format is similar to the 625 line format but the data rate is lower and there are less data bytes per packet (32 rather than 40). There are still 40 characters per display row so extra packets are sent each of which contains the last 8 characters for four rows. These packets can be identified by looking at the 'tabulation bit' (T), which replaces one of the magazine bits in 525 line teletext. When an ordinary packet with T = 1 is received, the decoder puts the data into the four rows starting with that corresponding to the packet number, but with the 2 LSBs set to 0. For example, a packet 9 with T = 1 (packet X/1/9) contains data for rows 8, 9, 10 and 11. The error checking carried out on data from packets with T = 1 depends on the

setting of the TXT1. 8 BIT bit and the error checking control bits in the page request data and is the same as that applied to the data written into the same memory location in the 625 line format.

The rolling time display (the last 8 characters in row 0) is taken from any packets X/1/1, 2 or 3 received. In parallel magazine mode only packets in the correct magazine are used for rolling time. Packet number X/1/0 is ignored.

The tabulation bit is also used with extension packets. The first 8 data bytes of packet X/1/24 are used to extend the Fastext prompt row to 40 characters. These characters are written into whichever part of the memory the packet 24 is being written into (determined by the 'X24 Posn' bit).

Packets X/0/27/0 contain 5 Fastext page links and the link control byte and are captured, Hamming checked and stored by in the same way as are packets X/27/0 in 625 line text. Packets X/1/27/0 are not captured.

Because there are only 2 magazine bits in 525 line text, packets with the magazine bits all set to 0 are referred to as being in magazine 4. Therefore, the broadcast service data packet is packet 4/30, rather than packet 8/30. As in 625 line text, the first 20 bytes of packet 4/30 contain encoded data which is decoded in the same way as that in packet 8/30. The last 12 bytes of the packet contains half of the parity encoded status message. Packet 4/0/30 contains the first half of the message and packet 4/1/30 contains the second half. The last 4 bytes of the message are not written into memory. The first 20 bytes of the each version of the packet are the same so they are stored whenever either version of the packet is acquired.

In 525 line text each packet 26 only contains ten 24/18 Hamming encoded data triplets, rather than the 13 found in 625 line text. The tabulation bit is used as an extra bit (the MSB) of the designation code, allowing 32 packet 26s to be transmitted for each page. The last byte of each packet 26 is ignored.

#### FASTEXT DETECTION

When a packet 27, designation code 0 is detected, whether or not it is acquired, the TXT13. FASTEXT bit is set. If the device is receiving 525 line teletext, a packet X/0/27/0 is required to set the flag. The flag can be reset by writing a 0 into the SFR bit.

#### BROADCAST SERVICE DATA DETECTION

When a packet 8/30 is detected, or a packet 4/30 when the device is receiving a 525 line transmission, the TXT13. Packet 8/30. The flag can be reset by writing a 0 into the SFR bit.

#### VPS ACQUISITION

When the TXT0. VPS ON bit is set, any VPS data present on line 16, field 0 of the CVBS signal at the input of the

## TV signal processor-Teletext decoder with embedded $\mu$ -Controller

## TDA935X/6X/8X PS/N2 series

teletext decoder is error checked and stored in row 25, block 9 of the basic page memory. The device automatically detects whether teletext or VPS is being transmitted on this line and decodes the data appropriately.

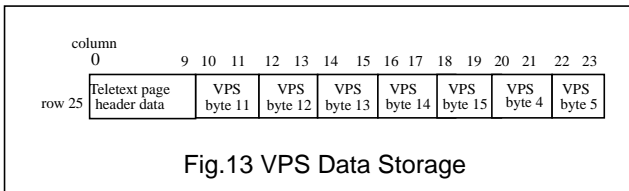

Each VPS byte in the memory consists of 4 bi-phase decoded data bits (bits 0-3), a bi-phase error flag (bit 4) and three 0s (bits 5-7). The TXT13. VPS Received bit is set by the hardware whenever VPS data is acquired. The flag can be reset by writing a 0 into the SFR bit.

### WSS ACQUISITION

The Wide Screen Signalling data transmitted on line 23 gives information on the aspect ratio and display position of the transmitted picture, the position of subtitles and on the camera/film mode. Some additional bits are reserved for future use. A total of 14 data bits are transmitted. All of the available data bits transmitted by the Wide Screen Signalling signal are captured and stored in SFRs WSS1, WSS2 and WSS3. The bits are stored as groups of related bits and an error flag is provided for each group to indicate when a transmission error has been detected in one or more of the bits in the group. Wide screen signalling data is only acquired when the TXT8.WSS ON bit is set. The TXT8.WSS RECEIVED bit is set by the hardware whenever wide screen signalling data is acquired. The flag can be reset by writing a 0 into the SFR bit.

### CLOSED CAPTION ACQUISITION

The US Closed Caption data is transmitted on line 21 (525 line timings) and is used for Captioning information, Text information and Extended Data Services. Closed Caption data is only acquired when TXT21.CC ON bit is set. Two bytes of data are stored per field in SFRs, the first byte is stored in CCDAT1 and the second byte is stored in CCDAT2. The value in the CCDAT registers are reset to 00h at the start of the Closed Caption line defined by CCLIN.CS<4:0>. At the end of the Closed Caption line an interrupt is generated if IE.ECC is active. The processing of the Closed Caption data to convert into a displayable format is performed by Software.

### DISPLAY

The display section is based on the requirements for a Level 1.5 WST Teletext and US Closed Caption. There are some enhancements for use with locally generated On-Screen Displays.

The display section reads the contents of the Display memory and interprets the control/character codes. Using this information and other global settings, the display produces the required RGB signals and Video/Data (Fast Blanking) signal for the TV signal processing.

The display is synchronised to the TV signal processing by way of Horizontal and Vertical sync signals generated within TDA935X/6x/8x. From these signals all display timings are derived.

### Display Features

- Teletext and Enhanced OSD modes
- Level 1.5 WST features
- US Closed Caption Features
- Serial and Parallel Display Attributes
- Single/Double/Quadruple Width and Height for characters
- Scrolling of display region.
- Variable flash rate controlled by software.
- Globally selectable scan lines per row 9/10/13/16.
- Globally selectable character matrix (HxV) 12x9, 12x10, 12x13, 12x16.
- Italics, Underline and Overline.
- Soft Colours using CLUT with 4096 colour palette.
- Fringing (Shadow) selectable from N-S-E-W direction.
- Fringe colour selectable.
- Meshing of defined area.
- Contrast reduction of defined area.
- Cursor.
- Special Graphics characters with two planes, allowing four colours per character.
- 32 Software re-definable On-Screen Display characters.
- 4 WST Character sets(G0/G2) in single device (e.g. Latin,Cyrillic,Greek,Arabic).
- G1 Mosaic graphics, Limited G3 Line drawing characters.
- WST Character sets and Closed Caption Character set in single device.

### Display Modes

The display section has two distinct modes with different features available in each. The two modes are:



## TV signal processor-Teletext decoder with embedded $\mu$ -Controller

## TDA935X/6X/8X PS/N2 series

- **TXT:** This is the display configured as the WST mode with additional serial and global attributes to enable the same functionality as the SAA5497 (ETT) device. The display is configured as a fixed 25 rows with 40 characters per row.
- **CC:** This is the display configured as the US Closed Caption mode with the same functionality as the PC83C771 device. The display is configured as a maximum of 16 rows with a maximum of 48 characters per row.

In both of the above modes the Character matrix, and TV lines per row can be defined. There is an option of 9, 10, 13 & 16 TV lines per display row, and a Character matrix (HxV) of 12x9, 12x10, 12x13, or 12x16. Not all combinations of TV lines per row and maximum display rows give a sensible OSD display, since there is limited number of TV scan lines available. Special Function Register, TXT21 is used to control the character matrix and lines per row.

### Display Features available in each mode

The following is a list of features available in each mode. Each setting can either be a serial or parallel attribute, and some have a global effect on the display.

Feature	TXT	CC
Flash	serial	serial
Boxes	Txt/OSD (Serial)	serial
Horizontal Size	x1/x2/x4 (serial)	x1/x2 (serial)
Vertical Size	x1/x2 (serial) x4 (global)	x1/x2 (serial)
Italic	N/A	serial
Foreground colours	8 (serial)	8+8 (parallel)
Background colours	8 (serial)	16 (serial)
Soft Colours (CLUT)	16 from 4096	16 from 4096
Underline	N/A	serial
Overline	N/A	serial
Fringe	N+S+E+W	N+S+E+W
Fringe Colour	16 (Global)	16 (Serial)
Meshing of Background	Black or Colour (Global)	All (Global)
Fast Blanking Polarity	YES	YES
Screen Colour	16 (Global)	16 (Global)
DRCS	32 (Global)	32 (Global)
Character Matrix (HxV)	12x9/10/13/16	12x9/10/13/16
No. of Rows	25	16
No. of Columns	40	48
No of Characters displayable	1000	768
Cursor	YES	YES
Special Graphics (2 planes per character)	16	16
Scroll	NO	YES

**Table 12** Display Features

## TV signal processor-Teletext decoder with embedded $\mu$ -Controller

## TDA935X/6X/8X PS/N2 series

### Display Feature Descriptions

#### FLASH

Flashing causes the foreground colour pixel to be displayed as the background pixels. The flash frequency is controlled by software setting and resetting display register REG0: Status at the appropriate interval.

CC: This attribute is valid from the time set (see Table 18) until the end of the row or until otherwise modified.

TXT: This attribute is set by the control character 'flash' (08h) and remains valid until the end of the row or until reset by the control character 'steady' (09h).

#### BOXES

CC: This attribute is valid from the time set until end of row or otherwise modified if set with Serial Mode 0. If set with Serial Mode 1, then it is set from the next character onwards.

In CC text mode the background colour is displayed regardless of the setting of the box attribute bit. Boxes take affect only during mixed mode, where boxes are set in this mode the background colour is displayed. Character locations where boxes are not set show video/screen colour (depending on the setting in the display control register. REG0: Display Control) in stead of the background colour.

TXT: Two types of boxes exist the Teletext box and the OSD box. The Teletext box is activated by the 'start box' control character (0Bh), Two start box characters are required begin a Teletext box, with box starting between the 2 characters. The box ends at the end of the line or after a 'end box' control character.

TXT mode can also use OSD boxes, they are started using size implying OSD control chracters(BCh/BDh/BEh/BFh). The box starts after the control character ('set after') and ends either at the end of the row or at the next size implying OSD character ('set at'). The attributes flash, teletext box, conceal, separate graphics, twist and hold graphics are all reset at the start of an OSD box, as they are at the start of the row. OSD Boxes are only valid in TV mode which is defined by TXT5=03h and TXT6=03h.

#### SIZE

The size of the characters can be modified in both the horizontal and vertical directions.

CC: Two sizes are available in both the horizontal and vertical directions. The sizes available are normal (x1), double (x2) height/width and any combination of these. The attribute setting is always valid for the whole row.

Mixing of sizes within a row is not possible.

TXT: Three horizontal sizes are available normal(x1),double(x2),quadruple(x4). The control characters 'normal size' (0Ch/BCh) enables normal size,

the 'double width' or double size (0Eh/BEh/0Fh/BFh) enables double width characters. Any two consecutive combination of 'double width' or 'double size' (0Eh/BEh/0Fh/Bfh) activates quadruple width characters, provided quadruple width characters are enabled by TXT4.Quad Width Enable. Three vertical sizes are available normal(x1),double(x2),quadruple(x4). The control characters 'normal size' (0Ch/BCh) enable normal size, the 'double height' or 'double size' (0Dh/BDh/0Fh/BFh) enable double height characters. Quadruple height character are achieved by using double height characters and setting the global attributes TXT7.Double Height (expand) and TXT7.Bottom/Top. If double height characters are used in teletext mode, single height characters in the lower row of the double height character are automatically disabled.

#### ITALIC

CC: This attribute is valid from the time set until the end of the row or otherwise modified. The attribute causes the character foreground pixels to be offset horizontally by 1 pixel per 4 scan lines (interlaced mode). The base is the bottom left character matrix pixel. The pattern of the character is indented as shown in Fig.14.

# TV signal processor-Teletext decoder with embedded $\mu$ -Controller TDA935X/6X/8X PS/N2 series

TXT: The Italic attribute is not available.

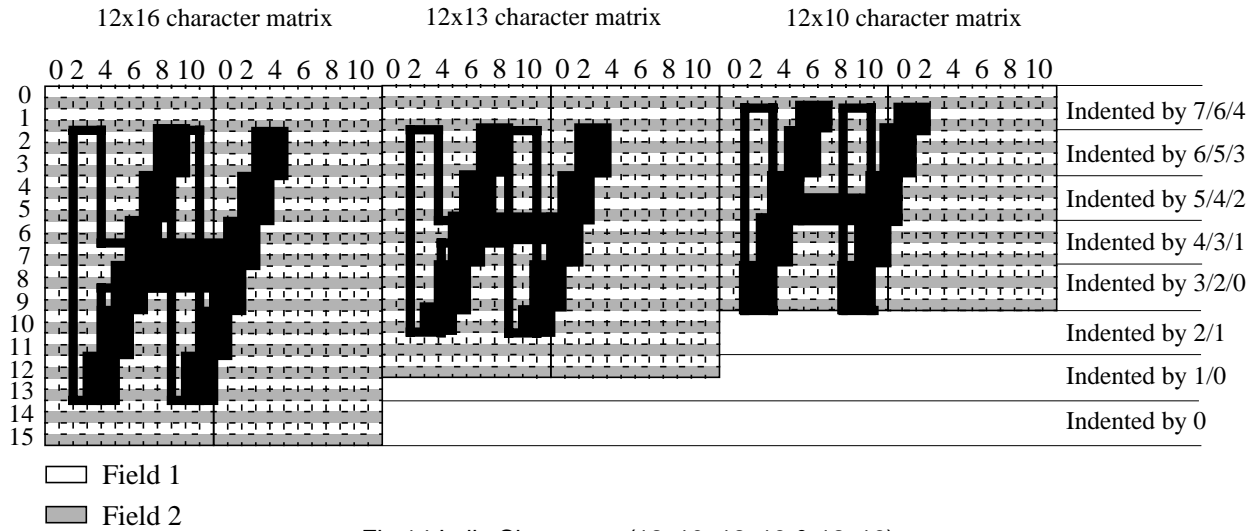

Fig.14 Italic Characters (12x10, 12x13 & 12x16).

**COLOURS**

*CLUT (Colour Look Up Table)*

A CLUT (Colour Look Up Table) with 16 colour entries is provided. The colours are programmable out of a palette of 4096(4 bits per R, G and B). The CLUT is defined by writing data to a RAM that resides in the MOVX address space of the 80C51.

RED3-0 b11..b4	GRN3-0 b7..b4	BLU3-0 b3..b0	Colour entry
0000	0000	0000	0
0000	0000	1111	1
...	...	...	...
1111	1111	0000	14
1111	1111	1111	15

**Table 13** CLUT Colour values

*Foreground Colour*

CC: The foreground colour can be chosen from 8 colours on a character by character basis. Two sets of 8 colours are provided. A serial attribute switches between the banks (see Table 18 Serial Mode 1, bit 7). The colours are the CLUT entries 0 to 7 or 8 to 15.

TXT: The foreground colour is selected via a control character. The colour control characters takes effect at the start of the next character (“Set-After”) and remain valid until the end of the row, or until modified by a control character. Only 8 foreground colours are available. The TEXT foreground control characters map to the CLUT entries as shown below:

Control Code	Defined Colour	CLUT Entry
00h	Black	0
01h	Red	1
02h	Green	2
03h	Yellow	3
04h	Blue	4
05h	Magenta	5
06h	Cyan	6
07h	White	7

**Table 14** Foreground CLUT mapping

*Background Colour*

CC: This attribute is valid from the time set until end of row or otherwise modified if set with Serial Mode 0. If set with Serial Mode 1, then the colour is set from the next character onwards.

The background colour can be chosen from all 16 CLUT entries.

# TV signal processor-Teletext decoder with embedded $\mu$ -Controller TDA935X/6X/8X PS/N2 series

**TXT:** The control character “New background” (“1Dh”) is used to change the background colour to the current foreground colour. The selection is immediate (“Set at”) and remains valid until the end of the row or until otherwise modified.

The TEXT background control characters map to the CLUT entries as shown below:

Control Code	Defined Colour	CLUT Entry
00h+1Dh	Black	8
01h+1Dh	Red	9
02h+1Dh	Green	10
03h+1Dh	Yellow	11
04h+1Dh	Blue	12
05h+1Dh	Magenta	13
06h+1Dh	Cyan	14
07h+1Dh	White	15

**Table 15** Background CLUT mapping

**BACKGROUND DURATION**

The attribute when set takes effect from the current position until to the end of the text display defined in REG4:Text Area End.

**CC:** The background duration attribute (see Table 18, Serial Mode 1, bit 8) in combination with the End Of Row attribute (see Table 18, Serial Mode 1, bit 9) forces the background colour to be display on the row until the end of the text area is reached.

**TXT:** This attribute is not available.

**UNDERLINE**

The underline attribute causes the characters to have the bottom scan line of the character cell forced to foreground colour, including spaces. If background duration is set, then underline is set until the end of the text area.

**CC:** The underline attribute (see Table 18, Serial Mode 0/1, bit 4) is valid from the time set until end of row or otherwise modified.

**TXT:** This attribute is not available.

**OVERLINE**

The overline attribute causes the characters to have the top scan line of the character cell forced to foreground colour, including spaces. If background duration is set, then overline is set until the end of the text area.

**CC:** The overline attribute (see Table 18, Serial Mode 0/1, bit 5) is valid from the time set until end of row or otherwise modified. Overlining of Italic characters is not possible.

**TXT:** This attribute is not available.

**END OF ROW**

**CC:** The number of characters in a row is flexible and can determined by the end of row attribute (see Table 18, Serial Mode 1, bit 9). However the maximum number of character positions displayed is determined by the setting of the REG2:Text Position Horizontal and REG4:Text Area End.

**NOTE:** When using the end of row attribute the next character location after the attribute should always be occupied by a 'space'.

**TXT:** This attribute is not available, Row length is fixed at 40 characters.

**FRINGING**

A fringe (shadow) can be defined around characters. The fringe direction is individually selectable in any of the North, South, East and West direction using REG3:Fringing Control. The colour of the fringe can also be defined as one of the entries in the CLUT, again using REG3:Fringing Control.

**CC:** The fringe attribute (see Table 18, Serial Mode 0, bit 9) is valid from the time set until the end of the row or otherwise modified.

**TXT:** The display of fringing in TXT mode is controlled by the TXT4.SHADOW bit. When set all the alphanumeric characters being displayed are shadowed, graphics characters are not shadowed.

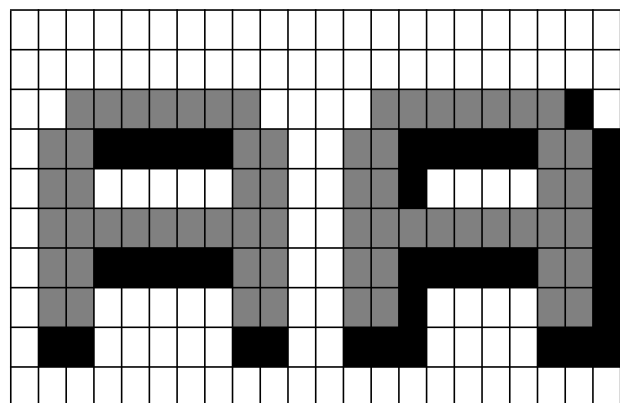

**Fig.15** South and Southwest Fringing

**MESHING**

The attribute effects the background colour being displayed. Alternate pixels are displayed as the background colour or video. The structure is offset by 1

TV signal processor-Teletext decoder with embedded  $\mu$ -Controller

TDA935X/6X/8X PS/N2 series

pixel from scan line to scan line, thus achieving a checker board display of the background colour and video.

TXT: There are two meshing attributes one that only affects black background colours TXT4.BMESH and a second that only affects backgrounds other than black TXT4.CMESH. A black background is defined as CLUT entry 8, a none black background is defined as CLUT entry 9-15.

CC: The setting of the Mesh bit in REG0:Display Control has the effect of meshing any background colour.

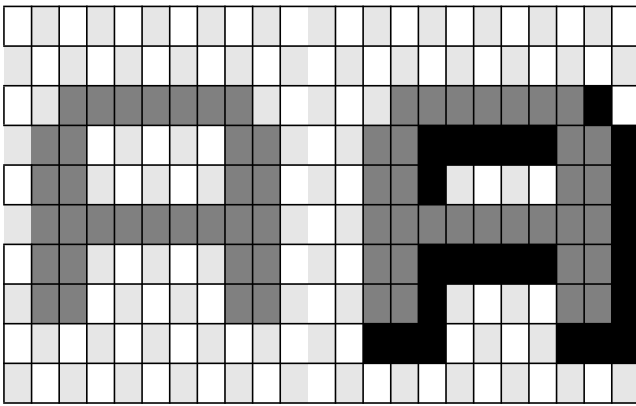

Fig.16 Meshing and Meshing / Fringing (South+West)

CURSOR

The cursor operates by reversing the background and foreground colours in the character position pointed to by the active cursor position. The cursor is enabled using TXT7.CURSOR ON. When active, the row the cursor appears on is defined by TXT9.R<4:0> and the column is defined by TXT10.C<5:0>. The position of the cursor can be fixed using TXT9.CURSOR FREEZE.

CC: The valid range for row is 0 to 15. The valid range for column is 0 to 47. The cursor remains rectangular at all times, it's shape is not affected by italic attribute, therefore it is not advised to use the cursor with italic characters.

TXT: The valid range for row positioning is 0 to 24. The valid range for column is 0 to 39.

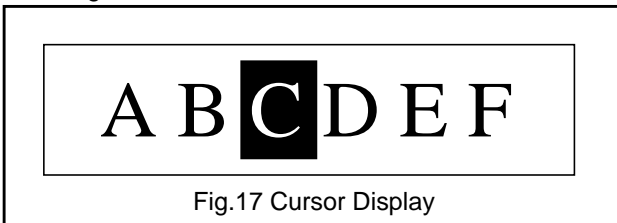

Fig.17 Cursor Display

SPECIAL GRAPHICS CHARACTERS

CC/TXT: Several special characters are provided for improved OSD effects. These characters provide a choice of 4 colours within a character cell. The total number of special graphics characters is limited to 16. They are stored in the character codes 8Xh and 9Xh of the character table (32 ROM characters), or in the DRCs which overlay character codes 8Xh and 9Xh. Each special graphics character uses two consecutive normal characters.

Fringing, underline and overline is not possible for special graphics characters. Special graphics characters are activated when TXT21.OSD\_PLANE = 1.

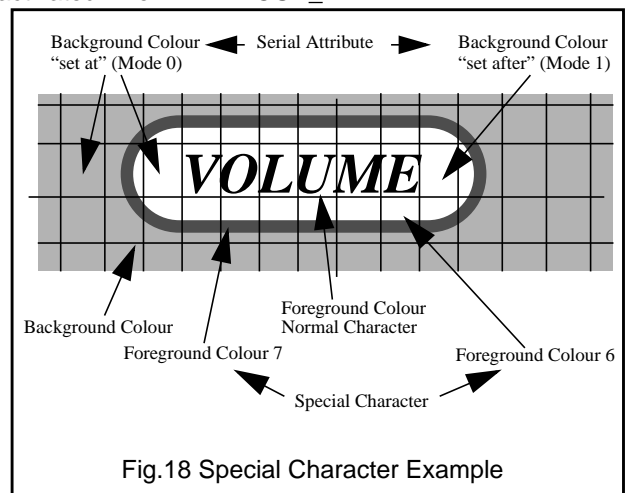

Fig.18 Special Character Example

The example in Fig.18 can be done with 8 special graphics characters.

If the screen colour is transparent (implicit in mixed mode) and inside the object the box attribute is set, then the object is surrounded by video. If the box attribute is not set the background colour inside the object will also be displayed as transparent.

Plane 1 0	Colour Allocation
0 0	Background Colour
0 1	Foreground Colour
1 0	CLUT entry 6
1 1	CLUT entry 7

Table 16 Special Character Colour allocation

TV signal processor-Teletext decoder with embedded  $\mu$ -Controller

TDA935X/6X/8X PS/N2 series

**Character and Attribute Coding**

CC MODE

Character coding is split into character oriented attributes (parallel) and character group coding (serial). The serial attributes take effect either at the position of the attribute (Set At), or at the following location (Set After) and remain effective until either modified by a new serial attribute or until the end of the row. A serial attribute is represented as a space (the space character itself however is not used for this purpose), the attributes that are still active, e.g. overline and underline will be visible during the display of the space. The default setting at the start of a row is:

- 1x size, flash and italics OFF
- overline and underline OFF
- Display mode = superimpose
- fringing OFF
- background colour duration = 0
- end of row = 0

The coding is done in 12 bit words. The codes are stored sequentially in the display memory. A maximum of 768 character positions can be defined for a single display.

PARALLEL CHARACTER CODING

Bits	Description
0-7	8 bit character code
8-10	3 bits for 8 foreground colours
11	Mode bit: 0 = Parallel code

**Table 17** Parallel Character Coding

TV signal processor-Teletext decoder with  
embedded  $\mu$ -Controller

## TDA935X/6X/8X PS/N2 series

## SERIAL CHARACTER CODING

Bits	Description		
	Serial Mode 0 ("set at")	Serial Mode 1	
		Char.Pos. 1 ("set at")	Char.Pos. >1 ("set after")
<b>0-3</b>	4 bits for 16 Background colours	4 bits for 16 Background colours	4 bits for 16 Background colours
<b>4</b>	0 = Underline OFF 1 = Underline ON	Horizontal Size: 0 = normal 1 = x2	0 = Underline OFF 1 = Underline ON
<b>5</b>	0 = Overline OFF 1 = Overline ON	Vertical Size: 0 = normal 1 = x2	0 = Overline OFF 1 = Overline ON
<b>6</b>	Display mode: 0 = Superimpose 1 = Boxing	Display mode: 0 = Superimpose 1 = Boxing	Display mode: 0 = Superimpose 1 = Boxing
<b>7</b>	0 = Flash OFF 1 = Flash ON	Foreground colour switch 0 = Bank 0 (colours 0-7) 1 = Bank 1 (colours 8-15)	Foreground colour switch 0 = Bank 0 (colours 0-7) 1 = Bank 1 (colours 8-15)
<b>8</b>	0 = Italics OFF 1 = Italics ON	Background colour duration: 0 = stop BGC 1 = set BGC to end of row	Background colour duration (set at): 0 = stop BGC 1 = set BGC to end of row
<b>9</b>	0 = Fringing OFF 1 = Fringing ON	End of Row 0 = Continue Row 1 = End Row	End of Row (set at): 0 = Continue Row 1 = End Row
<b>10</b>	Switch for Serial coding mode 0 and 1:  0 = mode 0	Switch for Serial coding mode 0 and 1:  1 = mode 1	Switch for Serial coding mode 0 and 1:  1 = mode 1
<b>11</b>	Mode bit:  1 = Serial code	Mode bit:  1 = Serial code	Mode bit:  1 = Serial code

**Table 18** Serial Character Coding

## TXT MODE

Character coding is in a serial format, with only one attributes being changed at any single location. The serial attributes take effect either at the position of the attribute

(Set At), or at the following location (Set After). The attribute remainseffective until either modified by new serial attributes or until the end of the row. The default settings at the start of a row is:

- foreground colour white (CLUT Address 7)
- background colour black (CLUT Address 8)

# TV signal processor-Teletext decoder with embedded $\mu$ -Controller TDA935X/6X/8X PS/N2 series

- Horizontal size x1, Vertical size x1 (normal size)
- Alphanumeric ON
- Contiguous Mosaic Graphics
- Release Mosaics
- Flash, Box, Conceal and Twist OFF

The attributes have individual codes which are defined in the basic character table below:

bits b7 b6 b5 b4 b3 b2 b1 b0		column																E/W = 0			E/W = 1						
		0	1	2	2a	3	3a	4	5	6	6a	7	7a	8	8a	9	9a	A	B	C	D	E	F	D	E	F	
0000	0	alpha black	graphics black			0		Nat Opt	P		Nat Opt		P		OSD	OSD	OSD	OSD	#	bkgnd black	U	è	è	è	č	č	č
0001	1	alpha red	graphics red	!		1		A	Q	a		q		OSD	OSD	OSD	OSD	\$	bkgnd red	Á	ò	ò	ò	í	í	í	
0010	2	alpha green	graphics green	"		2		B	R	b		r		OSD	OSD	OSD	OSD	X	bkgnd green	É	ó	ó	ó	ň	ň	ň	
0011	3	alpha yellow	graphics yellow	Nat Opt		3		C	S	c		s		OSD	OSD	OSD	OSD	Y	bkgnd yellow	İ	ù	ù	ù	ř	ř	ř	
0100	4	alpha blue	graphics blue	Nat Opt		4		D	T	d		t		OSD	OSD	OSD	OSD	Z	bkgnd blue	Ó	í	í	í	š	š	š	
0101	5	alpha magenta	graphics magenta	%		5		E	U	e		u		OSD	OSD	OSD	OSD	è	bkgnd magenta	Ü	ê	ê	ê	ý	ý	ý	
0110	6	alpha cyan	graphics cyan	&		6		F	V	f		v		OSD	OSD	OSD	OSD	ó	bkgnd cyan	Ð	÷	÷	÷	ž	ž	ž	
0111	7	alpha white	graphics white	'		7		G	W	w		w		OSD	OSD	OSD	OSD	ü	bkgnd white	Š	←	←	←	č	č	č	
1000	8	flash	conceal display	(		8		H	X	x		x		OSD	OSD	OSD	OSD	ä		Š	→	→	→	č	č	č	
1001	9	steady	contiguous graphics	)		9		I	Y	y		y		OSD	OSD	OSD	OSD	ë		á	↑	↑	↑	ň	ň	ň	
1010	A	end box	separated graphics	*		:		J	Z	j		z		OSD	OSD	OSD	OSD	ö		í	Û	Û	Û	ř	ř	ř	
1011	B	start box	twist	+		;		K			Nat Opt	k		Nat Opt		OSD	OSD	Ü		ó	i	i	i	š	š	š	
1100	C	normal height	black bkgnd	,		<		L			Nat Opt	l		Nat Opt		OSD	OSD	á	norm sz OSD	Á	ó	ó	ó	ý	ý	ý	
1101	D	double height	new bkgnd	-		=		M			Nat Opt	m		Nat Opt		OSD	OSD	é	dbl ht OSD	É	í	í	í	ž	ž	ž	
1110	E	double width	hold graphics	.		>		N			Nat Opt	n		Nat Opt		OSD	OSD	ı	dbl wd OSD	İ	ï	ï	ï	š	š	š	
1111	F	double size	release graphics	/		?		O			Nat Opt	o			OSD	OSD	ö	dbl sz OSD	Ö	à	à	à	ü	ü	ü		

Fig.19 TXT Basic Character Set (Pan-European)



# TV signal processor-Teletext decoder with embedded $\mu$ -Controller TDA935X/6X/8X PS/N2 series

**Screen and Global Controls**

A number of attributes are available that affect the whole display region, and cannot be applied selectively to regions of the display.

**TV SCAN LINES PER ROW**

The number of TV scan lines per field used for each display row can be defined, the value is independent of the character size being used. The number of lines can be either 10/13/16 per display row. The number of TV scan lines per row is defined `TXT21.DISP_LINES<1:0>`. A value of 9 lines per row can be achieved if the display is forced into 525 line display mode by `TXT17.DISP_FORCE<1:0>`, or if the device is in 10 line mode and the automatic detection circuitry within display finds 525 line display syncs.

**CHARACTER MATRIX (HXV)**

There are four different character matrices available, these are 12x10, 12x13, and 12x16. The selection is made using `TXT21.CHAR_SIZE<1:0>` and is independent of the number of display lines per row. If the character matrix is less than the number of TV scan lines per row then the matrix is padded with blank lines. If the character matrix is greater than the number of TV scan lines then the character is truncated.

**DISPLAY MODES**

CC: When attributes superimpose or when boxing (see Table 18, Serial Mode 0/1, bit 6) is set, the resulting display depends on the setting of the following screen control mode bits in `REG0:Display Control`.

Display Mode	MOD 1 0	Description
<b>Video</b>	0 0	Video mode disables all display activities and sets the RGB to true black and VDS to video.
<b>Full Text</b>	0 1	Full Text mode displays screen colour at all locations not covered by character foreground or background colour. The box attribute has no effect.
<b>Mixed Screen Colour</b>	1 0	Mixed Screen mode displays screen colour at all locations not covered by character foreground, within boxed areas or, background colour.
<b>Mixed Video</b>	1 1	Mixed Video mode displays video at all locations not covered by character foreground, within boxed areas or, background colour.

**Table 19** Display Modes

TXT: The display mode is controlled by the bits in the `TXT5` and `TXT6`. There are 3 control functions - Text on, Background on and Picture on. Separate sets of bits are used inside and outside Teletext boxes so that different display modes can be invoked. `TXT6` is used if the newsflash (C5) or subtitle (C6) bits in row 25 of the basic page memory are set otherwise `TXT5` is used. This allows the software to set up the type of display required on newsflash and subtitle pages (e.g. text inside boxes, TV picture outside) this will be invoked without any further software intervention when such a page is acquired.

Picture On	Text On	Background On	Effect
0	0	x	Text mode, black screen
0	1	0	Text mode, background always black
0	1	1	Text mode
1	0	x	Video mode
1	1	0	Mixed text and TV mode
1	1	1	Text mode, TV picture outside text area

**Table 20** TXT Display Control Bits

TV signal processor-Teletext decoder with embedded  $\mu$ -Controller

TDA935X/6X/8X PS/N2 series

Screen Colour

Screen colour is displayed from 10.5 ms to 62.5 ms after the active edge of the HSync input and on TV lines 23 to 310 inclusive, for a 625 line display, and lines 17 to 260 inclusive for a 525 line display.

The screen colour is defined by REG0:Display Control and points to a location in the CLUT table. The screen colour covers the full video width. It is visible when the Full Text or Mixed Screen Colour mode is set and no foreground or background pixels are being displayed.

Text Display Controls

TEXT DISPLAY CONFIGURATION

Two types of area are possible. The one area is static and the other is dynamic. The dynamic area allows scrolling of a region to take place. The areas cannot cross each other. Only one scroll region is possible.

Display Map

The display map allows a flexible allocation of data in the memory to individual rows.

Sixteen words are provided in the display memory for this purpose. The lower 10 bits address the first word in the memory where the row data starts. This value is an offset in terms of 16-bit words from the start of Display Memory (8000 Hex). The most significant bit enables the display when not within the scroll (dynamic) area.

The display map memory is fixed at the first 16 words in the closed caption display memory.

b11	b10	b9	b8	b7	b6	b5	b4	b3	b2	b1	b0
Pointer to Row Data											
Reserved, should be set to 0											
Text Display Enable, valid outside Soft Scroll Area											
0 = Disable											
1 = Enable											

Table 21 Display map Bit Allocation

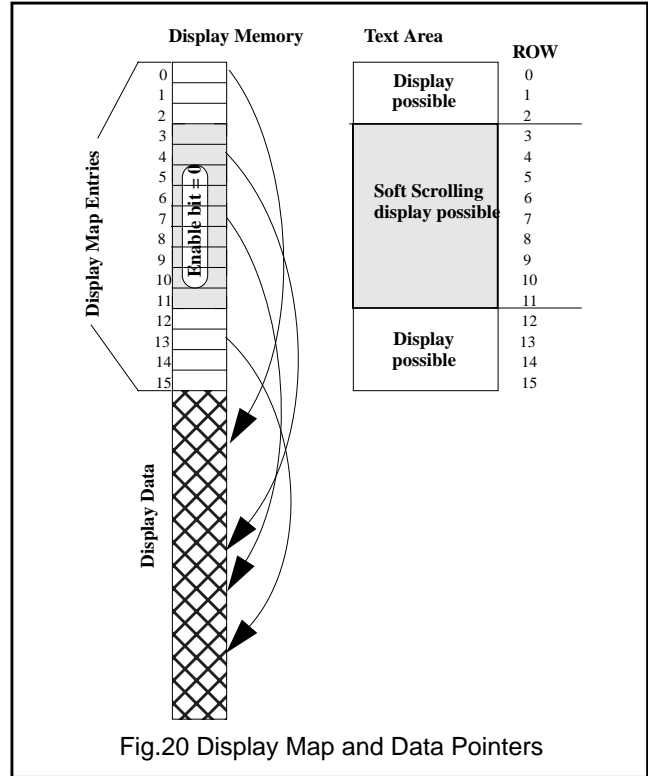

Fig.20 Display Map and Data Pointers

SOFT SCROLL ACTION

The dynamic scroll region is defined by the REG5:Scroll Area, REG6:Scroll Range, REG14:Top Scroll line and the REG8:Status Register. The scroll area is enabled when the SCON bit is set in REG8: Status.

The position of the soft scroll area window is defined using the Soft Scroll Position (SSP<3:0>), and the height of the window is defined using the Soft Scroll Height (SSH<3:0>) both are in REG6:Scroll Range. The rows that are scrolled through the window are defined using the Start Scroll Row (STS<3:0>) and the Stop Scroll Row (SPS<3:0>) both are in REG5:Scroll Area.

The soft scrolling function is done by modifying the Scroll Line (SCL<3:0>) in REG14: Top Scroll Line. and the first scroll row value SCR<3:0> in REG8:Status. If the number of rows allocated to the scroll counter is larger than the defined visible scroll area, this allows parts of rows at the top and bottom to be displayed during the scroll function. The registers can be written throughout the field and the values are updated for display with the next field sync. Care should be taken that the register pairs are written to by the software in the same field.

Only a region that contains only single height rows or only double height rows can be scrolled.

TV signal processor-Teletext decoder with embedded  $\mu$ -Controller

TDA935X/6X/8X PS/N2 series

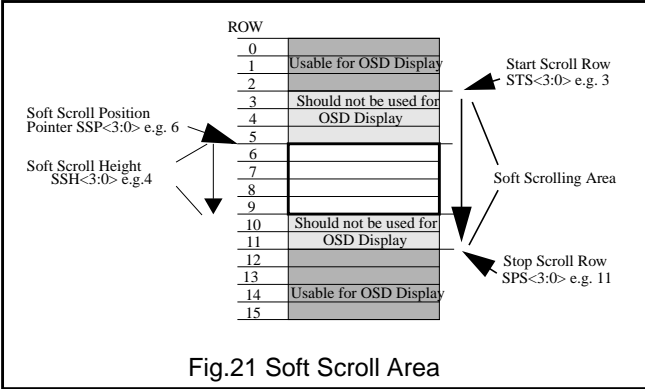

Fig.21 Soft Scroll Area

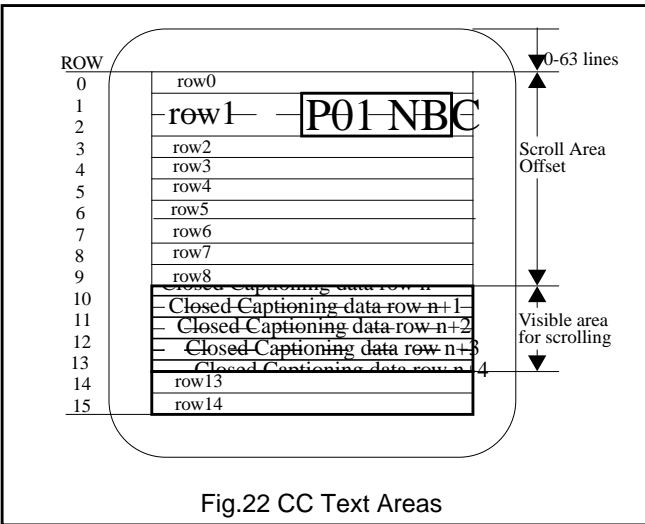

Fig.22 CC Text Areas

Display Positioning

The display consists of the **Screen Colour** covering the whole screen and the **Text Area** that is placed within the visible screen area. The screen colour extends over a large vertical and horizontal range so that no offset is needed. The text area is offset in both directions relative to the vertical and horizontal sync pulses.

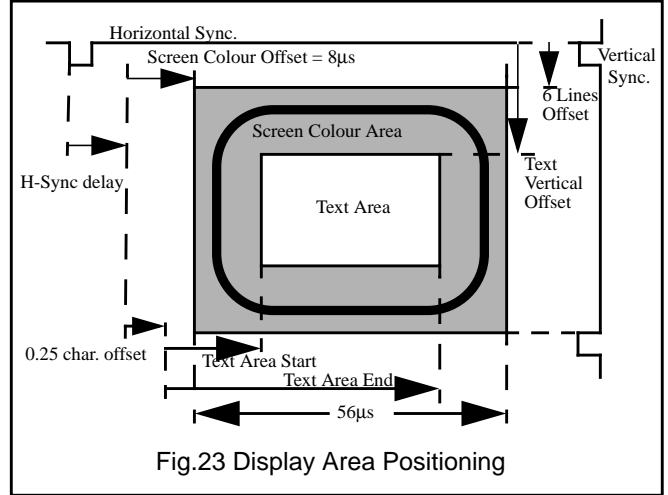

Fig.23 Display Area Positioning

SCREEN COLOUR DISPLAY AREA

This area is covered by the screen colour. The screen colour display area starts with a fixed offset of 8 us from the leading edge of the horizontal sync pulse in the horizontal direction. A vertical offset is not necessary.

<b>Horizontal</b>	starts 8 us after the leading edge of H-Sync for 56 us.
<b>Vertical</b>	line 9, field 1 (321, field 2) with respect to leading edge of vertical sync (line numbering using 625 Standard).

Table 22 Screen Colour Display Area

TEXT DISPLAY AREA

The text area can be defined to start with an offset in both the horizontal and vertical direction.

<b>Horizontal</b>	Up to 48 full sized characters per row. Start position setting from 3 to 64 characters from the leading edge of H-Sync. Fine adjustment in quarter characters.
<b>Vertical</b>	256 lines (nominal 41- 297). Start position setting from leading edge of vertical sync legal values are 4 to 64 lines. (line numbering using 625 Standard)

Table 23 Text Display Area

The horizontal offset is set in REG2: Text Area Start. The offset is done in full width characters using TAS<5:0> and quarter characters using HOP<1:0> for fine setting. The

# TV signal processor-Teletext decoder with embedded $\mu$ -Controller TDA935X/6X/8X PS/N2 series

values 00h to 03h for TAS<5:0> will result in a corrupted display.

The width of the text area is defined in REG4:Text Area End by setting the end character value TAE<5:0>. This number determines where the background colour of the Text Area will end if set to extend to the end of the row. It will also terminate the character fetch process thus eliminating the necessity of a row end attribute. This entails however writing to all positions.

The vertical offset is set in REG1:Text Position Vertical Register. The offset value VOL<5:0> is done in number of TV scan lines.

NOTE: REG1:Text Position Vertical Register should not be set to 00 Hex as the Display Busy interrupt is not generated in these circumstances.

### Character Set

To facilitate the global nature of the device the character set has the ability to accommodate a large number of characters, which can be stored in different matrices.

### CHARACTER MATRICES

The character matrices that can be accommodated are: - (HxVxPlanes) 12x9x1, 12x10x1, 12x13x1, 12x16x1.

These modes allow two colours per character position.

In CC mode two additional character matrices are available to allow four colours per character: - (HxVxPlanes) 12x13x2, 12x16x2.

The characters are stored physically in ROM in a matrix of size either 12x10 or 12x16.

### CHARACTER SET SELECTION

Four character sets are available in the device. A set can consist of alphanumeric characters as required by the WST Teletext or FCC Closed Captioning, Customer definable On-Screen Display characters, and Special Graphic characters.

CC:- Only a single character set can be used for display and this is selected using the Basic Set selection TXT18.BS<1:0>. When selecting a character set in CC mode the Twist Set selection TXT18.TS<1:0> should be set to the same value as TXT18.BS<1:0> for correct operation.

TXT:- Two character sets can be displayed at once. These are the basic G0 set or the alternative G0 set (Twist Set). The basic set is selected using TXT18.BS<1:0>, The alternative/twist character set is defined by TXT19.TS<1:0>. Since the alternative character set is an option it can be enabled or disabled using TXT19.TEN, and the language code that is defined for the alternative set is defined by TXT19.TC<2:0>.

### ROM ADDRESSING

Three ROM's are used to generate the correct pixel information. The first contains the National Option look-up table, the second contains the Basic Character look-up table and the third contains the Character Pixel information. Although these are individual ROM, since they do not need to be accessed simultaneously they are all combined into a single ROM unit.

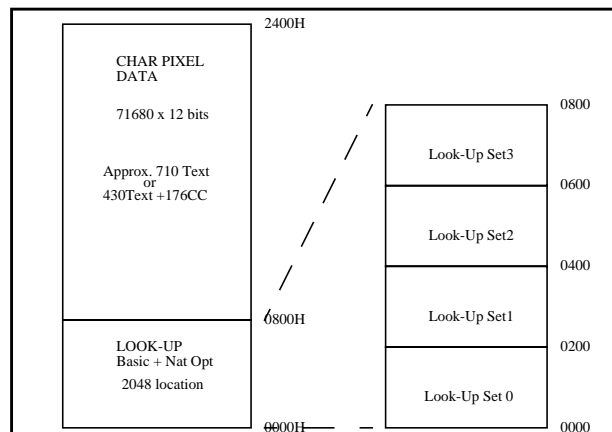

Fig.24 ROM Organisation

TV signal processor-Teletext decoder with embedded  $\mu$ -Controller

TDA935X/6X/8X PS/N2 series

CHARACTER TABLE

The character table is shown in Table 24:-

		Character code columns (Bits 4-7)															
		0	1	2	3	4	5	6	7	8	9	A	B	C	D	E	F
Character code rows (Bits 0-3)	0		®	SP	0	@	P	ú	p								
	1		·	!	1	A	Q	a	q								
	2		1/2	"	2	B	R	b	r								
	3		¿	#	3	C	S	c	s								
	4		™	\$	4	D	T	d	t								
	5		¢	%	5	E	U	e	u								
	6		£	&	6	F	V	f	v								
	7		♪	´	7	G	W	g	w								
	8		à	(	8	H	X	h	x								
	9		_	)	9	I	Y	i	y								
	A		è	á	:	J	Z	j	z								
	B		â	+	;	K	[	k	ç								
	C		ê	,	<	L	é	l									
	D		î	-	=	M	]	m	Ñ								
	E		ô	.	>	N	í	n	ñ								
	F		û	/	?	O	ó	o	n								

Table 24 Closed Caption Character Table

- Special Characters are in column 8.
- Additional table locations for normal characters
- Table locations for normal characters

**Re-definable Characters**

A number of Dynamically Re-definable Characters (DRC) are available. These are mapped onto the normal character codes, and replace the pre-defined OTP character Rom value.

There are 32 DRCs which occupy character codes 80H to 9FH. Alternatively, These locations can be utilized as 16 special graphics characters. The remapping of the standard OSD to the DRCs is activated when the TXT21.DRCS ENABLE bit is set. The selection of Normal or Special OSD symbols is defined by the TXT21.OSD PLANES.

Each character is stored in a matrix of 16x16x1 (V x H x planes), this allows for all possible character matrices to be defined within a single location.

# TV signal processor-Teletext decoder with embedded $\mu$ -Controller

## TDA935X/6X/8X PS/N2 series

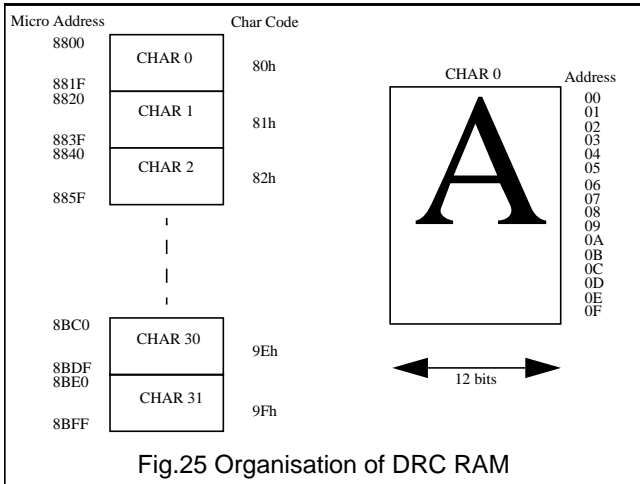

Fig.25 Organisation of DRC RAM

### DEFINING CHARACTERS

The DRC RAM is mapped on to the 80C51 RAM address space and starts at location 8800H. The character matrix is 12 bits wide and therefore requires two bytes to be written for each word, the first byte (even addresses), addresses the lower 8 bits and the second byte (odd addresses) addresses the upper 4 bits.

For characters of 9, 10 or 16 lines high the pixel information starts in the first address and continues sequentially for the required number of addresses. Characters of 13 lines high are defined with an initial offset of 1 address, this is to allow for correct generation of fringing across boundaries of clustered characters (see Fig.26). The characters continue sequentially for 13 lines after which a further line can again be used for generation of correct fringing across boundaries of clustered characters.

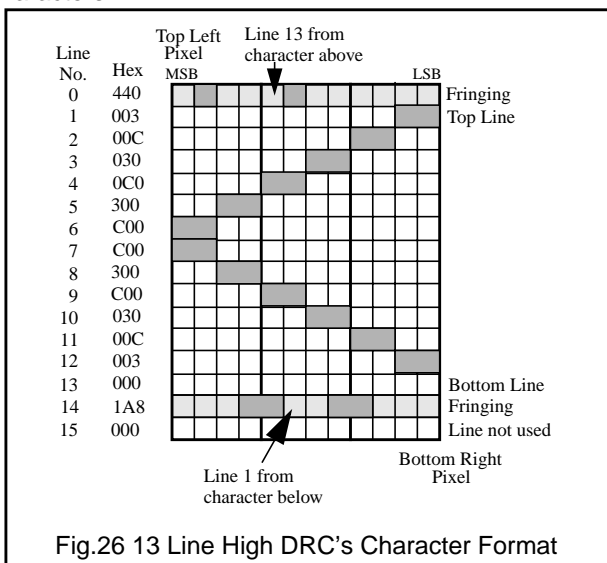

Fig.26 13 Line High DRC's Character Format

DRCs are defined by writing data to the DRC RAM using the 80C51 MOVX command. Setting bits 3 to 9 of the first line of a 12 wide by 16 line character would require setting the high byte of the 80C51 data pointer to 88H, the low byte of the 80C51 data pointer to 00H, using the MOVX command to load address 8800H with data F8H, incrementing the data pointer, and finally using the MOVX command to load address 8801H with data 03H.

### Display Synchronization

The horizontal and vertical synchronizing signals from the TV deflection are used as inputs. Both signals can be inverted before being delivered to the Phase Selector section.

CC: The polarity is controlled using either VPOL or HPOL in REG2:Text position Vertical.

TXT: SFRs bits TXT1.HPOL & TXT1.VPOL control the polarity.

A line locked 12 MHz clock is derived from the 12MHz free running oscillator by the Phase Selector. This line locked clock is used to clock the whole of the Display block.

The H & V Sync signals are synchronized with the 12 MHz clock before being used in the display section.

### Video/Data Switch (Fast Blanking) Polarity

The polarity of the Video/Data (Fast Blanking) signal can be inverted. The polarity is set with the VDSPOL in REG7: RGB Brightness register.

VDSPOL	VDS	Condition
0	1	RGB display
0	0	Video Display
1	0	RGB display
1	1	Video Display

Table 25 Fast Blanking Signal Polarity

### Video/Data Switch Adjustment

To take into account the delay between the RGB values and the VDS signal due to external buffering, the VDS signal can be moved in relation to the RGB signals. The VDS signal can be set to be either a clock cycle before or after the RGB signal, or coincident with the RGB signal. This is done using VDEL<2:0> in REG15:Configuration.

# TV signal processor-Teletext decoder with embedded $\mu$ -Controller

## TDA935X/6X/8X PS/N2 series

### RGB Brightness Control

A brightness control is provided to allow the RGB upper output voltage level to be modified. The RGB amplitude may be varied between 60% and 100%.

The brightness is set in the RGB Brightness register as follows: -

BRI3-0	RGB Brightness
0 0 0 0	Lowest value
...	...
1 1 1 1	Highest value

**Table 26** RGB Brightness

### Contrast Reduction

TXT: The COR bits in SFRs TXT5 & TXT6 control when the COR output of the device is activated (i.e. Pulled-low).

This output is intended to act on the TV's display circuits to reduce contrast of the video when it is active. The result of contrast reduction is to improve the readability of the text in a mixed teletext and video display.

The bits in the TXT5 & TXT6 SFRs allow the display to be set up so that, for example, the areas inside teletext boxes will be contrast reduced when a subtitle is being displayed but that the rest of the screen will be displayed as normal video.

CC: This feature is not available in CC mode.

### Memory Mapped Registers

The memory mapped registers are used to control the display. The registers are mapped into the Microcontroller MOVX address space, starting at address 87F0h and extending to 87FF.

### MMR MAP

ADD	R/W	Names	BIT7	BIT6	BIT5	BIT4	BIT3	BIT2	BIT1	BIT0
87F0	R/W	Display Control	SRC<3>	SRC<2>	SRC<1>	SRC<0>	-	MSH	MOD<1>	MOD<0>
87F1	R/W	Text Position Vertical	VPOL	HPOL	VOL<5>	VOL<4>	VOL<3>	VOL<2>	VOL<1>	VOL<0>
87F2	R/W	Text Area Start	HOP<1>	HOP<0>	TAS<5>	TAS<4>	TAS<3>	TAS<2>	TAS<1>	TAS<0>
87F3	R/W	Fringing Control	FRC<3>	FRC<2>	FRC<1>	FRC<0>	FRDN	FRDE	FRDS	FRDW
87F4	R/W	Text Area End	-	-	TAE<5>	TAE<4>	TAE<3>	TAE<2>	TAE<1>	TAE<0>
87F5	R/W	Scroll Area	SSH<3>	SSH<2>	SSH<1>	SSH<0>	SSP<3>	SSP<2>	SSP<1>	SSP<0>
87F6	R/W	Scroll Range	SPS<3>	SPS<2>	SPS<1>	SPS<0>	STS<3>	STS<2>	STS<1>	STS<0>
87F7	R/W	RGB Bright.ness	VDSPOL	-	-	-	BRI<3>	BRI<2>	BRI<1>	BRI<0>
87F8	R	Status read	BUSY	FIELD	SCON	FLR	SCR<3>	SCR<2>	SCR<1>	SCR<0>
87F8	W	Status write	-	-	SCON	FLR	SCR<3>	SCR<2>	SCR<1>	SCR<0>
87FC	R/W	H-Sync. Delay	-	HSD<6>	HSD<5>	HSD<4>	HSD<3>	HSD<3>	HSD<1>	HSD<0>
87FD	R/W	V-Sync. Delay	-	VSD<6>	VSD<5>	VSD<4>	VSD<3>	VSD<2>	VSD<1>	VSD<0>
87FE	R/W	Top Scroll Line	-	-	-	-	SCL<3>	SCL<2>	SCL<1>	SCL<0>
87FF	R/W	Configuration	CC	VDEL<2>	VDEL<1>	VDEL<0>	TXT/V	-	-	-

**Table 27** MMR Memory Map

TV signal processor-Teletext decoder with  
embedded  $\mu$ -Controller

## TDA935X/6X/8X PS/N2 series

## MMR BIT DEFINITION

Names	ADD	BIT7	BIT6	BIT5	BIT4	BIT3	BIT2	BIT1	BIT0	RESET
<b>Display Control.</b>	87F0	SRC<3>	SRC<2>	SRC<1>	SRC<0>	-	MSH	MOD<1>	MOD<0>	00H
SRC<3:0>	Screen Colour definition									
MSH	0 - No meshing of background 1 - Meshing all background colours									
MOD<1:0>	00 - Video 01 - Full Text 10 - Mixed Screen Colour 11 - Mixed Video									
<b>Text Position Vertical</b>	87F1	VPOL	HPOL	VOL<5>	VOL<4>	VOL<3>	VOL<2>	VOL<1>	VOL<0>	00H
VPOL	0 - Input polarity 1 - Inverted input polarity									
HPOL	0 - Input Polarity 1 - Inverted input polarity									
VOL<5:0>	Display start Vertical Offset from V-Sync. (lines)									
<b>Text Area Start</b>	87F2	HOP<1>	HOP<0>	TAS<5>	TAS<4>	TAS<3>	TAS<2>	TAS<1>	TAS<0>	00H
HOP<1:0>	Fine Horizontal Offset in quarter of characters									
TAS<5:0>	Text area start									
<b>Fringing Control.</b>	87F3	FRC<3>	FRC<2>	FRC<1>	FRC<0>	FRDN	FRDE	FRDS	FRDW	00H
FRC<3:0>	Fringing colour, value address of CLUT									
FRDN	0 - No fringe in North direction 1 - Fringe in North direction									
FRDE	0 - No fringe in East direction 1 - Fringe in East direction									
FRDS	0 - No fringe in South direction 1 - Fringe in South direction									
FRDW	0 - No fringe in West direction 1 - Fringe in West direction									
<b>Text Area End</b>	87F4	-	-	TAE<5>	TAE<4>	TAE<3>	TAE<2>	TAE<1>	TAE<0>	00H
TAE<5:0>	Text Area End, in full characters									
<b>Scroll Area</b>	87F5	SSH<3>	SSH<2>	SSH<1>	SSH<0>	SSP<3>	SSP<2>	SSP<1>	SSP<0>	00H
SSH<3:0>	Soft Scroll Height									
SSP<3:0>	Soft Scroll Position									
<b>Scroll Range</b>	87F6	SPS<3>	SPS<2>	SPS<1>	SPS<0>	STS<3>	STS<2>	STS<1>	STS<0>	00H
SPS<3:0>	Stop Scroll row									
STS<3:0>	Start Scroll row									
<b>RGB Brightness</b>	87F7	VDSPOL	-	-	-	BRI<3>	BRI<2>	BRI<1>	BRI<0>	00H



TV signal processor-Teletext decoder with  
embedded  $\mu$ -Controller

## TDA935X/6X/8X PS/N2 series

VDSPOL	VDS Polarity 0 - RGB (1), Video (0) 1 - RGB (0), Video (1)									
BRI<3:0>	RGB Brightness control									
<b>Status read</b>	87F8	BUSY	FIELD	SCON	FLR	SCR<3>	SCR<2>	SCR<1>	SCR<0>	00H
BUSY	0 - Access to display memory will not cause display problems 1 - Access to display memory could cause display problems.									
FIELD	0 - Odd Field 1 - Even Field									
FLR	0 - Active flash region foreground and background displayed 1 - Active flash region background only displayed									
SCR<3:0>	First scroll row									
<b>Status write</b>	87F8	-	-	SCON	FLR	SCR<3>	SCR<2>	SCR<1>	SCR<0>	00H
SCON	0 - Scroll area disabled 1 - Scroll area enabled									
FLR	0 - Active flash region foreground and background colour displayed 1 - Active flash region background colour only displayed									
SCR<3:0>	First Scroll Row									
<b>H-Sync. delay</b>	87FC	-	HSD<6>	HSD<5>	HSD<4>	HSD<3>	HSD<3>	HSD<1>	HSD<0>	00H
HSD<6:0>	H-Sync delay, in full size characters									
<b>V-Sync Delay</b>	87FD	-	VSD<6>	VSD<5>	VSD<4>	VSD<3>	VSD<2>	VSD<1>	VSD<0>	00H
VSD<6:0>	V-Sync delay in number of TV lines									
<b>Top Scroll Line</b>	87FE	-	-	-	-	SCL<3>	SCL<2>	SCL<1>	SCL<0>	00H
SCL<3:0>	Top line for scroll									
<b>Configuration</b>	87FF	CC	VDEL<2>	VDEL<1>	VDEL<0>	TXT/V	-	-	-	00H
CC	0 - OSD mode 1 - Closed Caption mode									
VDEL<2:0>	Pixel delay between VDS and RGB output 000 - VDS switched to video, not active 001 - VDS active one pixel earlier then RGB 010 - VDS synchronous to RGB 100 - VDS active one pixel after RGB									
TXT/V	BUSY Signal switch 1 - Horizontal 0 - Vertical									

Table 28 MMR Descriptions

## TV signal processor-Teletext decoder with embedded $\mu$ -Controller

## TDA935X/6X/8X PS/N2 series

### OTP MEMORY

These may be programmed either using the Parallel Programming Interface or via the ISP Programming Interface.

security bits are one-time programmable and CANNOT be erased.

### Parallel Programming

The following pins form the parallel programming interface:-

Pin	Name	Function
P0.5	IO(0)	Bit 0:- Address/Data/Mode
P0.6	IO(1)	Bit 1:- Address/Data/Mode
P1.0	IO(2)	Bit 2:- Address/Data/Mode
P1.1	IO(3)	Bit 3:- Address/Data/Mode
P1.2	IO(4)	Bit 4:- Address/Data/Mode
P1.3	IO(5)	Bit 5:- Address/Data/Mode
P3.1	IO(6)	Bit 6:- Address/Data/Mode
P3.2	IO(7)	Bit 7:- Address/Data/Mode
P2.0	OEB	Output Enable 0 = IO is output 1 = IO is input
P3.0	WEB	Write Enable, programming pulse >100us 0 = Program
P1.6	MODE	0 = IO(7:0) defined by A/DB 1 = IO(7:0) contains mode information
P1.7	A/DB	0 = IO(7:0) contains Data 1 = IO(7:0) contains Address Information
P3.3		Unused
VPE	VPE	9V Programming Voltage
RESET	RESET	Device reset/ mode selection
XTALIN	CLK	Clock 4 MHz

**Table 29** Parallel Programming Interface

### ISecurity Bits

The family of devices have a set of security bits for the combined OTP Program ROM, Character ROM and Packet 26 ROM. The security bits are used to prevent the ROM from being overwritten once programmed, and also the contents being verified once programmed. The

TV signal processor-Teletext decoder with embedded  $\mu$ -Controller

TDA935X/6X/8X PS/N2 series

The memory and security bits are structured as follows:-

MEMORY		SECURITY BITS INTERACTION		
PROGRAM ROM	USER ROM (i.e. 128k x 8 bits)	USER ROM Programming (Enable/Disable)	TEST ROM Programming (Enable/Disable)	Verify (Enable/Disable)
	TEST ROM RESERVED (1k x 8 bits)	Yes	No	Yes
CHARACTER ROM	USER ROM (9k x 12 bits)	USER ROM Programming (Enable/Disable)	TEST ROM Programming (Enable/Disable)	Verify (Enable/Disable)
	TEST ROM RESERVED (0.5k x 12 bits)	No	Yes	Yes
PACKET 26 ROM	USER ROM (4k x 8 bits)	USER ROM Programming (Enable/Disable)	TEST ROM Programming (Enable/Disable)	Verify (Enable/Disable)
		Yes	No	Yes

**Table 30** Security bit structure

The security bits are set as follows for production programmed devices (i.e. programmed by Philips):-

MEMORY		SECURITY BITS SET		
PROGRAM ROM		USER ROM Programming (Enable/Disable)	TEST ROM Programming (Enable/Disable)	Verify (Enable/Disable)
CHARACTER ROM		DISABLED	DISABLED	ENABLED
PACKET 26 ROM		DISABLED	DISABLED	ENABLED

**Table 31** Security bits for production devices

The security bits are set as follows for production un-programmed (blank) devices:-

MEMORY		SECURITY BITS SET		
PROGRAM ROM		USER ROM Programming (Enable/Disable)	TEST ROM Programming (Enable/Disable)	Verify (Enable/Disable)
CHARACTER ROM		ENABLED	DISABLED	ENABLED
PACKET 26 ROM		ENABLED	DISABLED	ENABLED

**Table 32** Security bits for Blank devices

TV signal processor-Teletext decoder with  
embedded  $\mu$ -Controller

TDA935X/6X/8X PS/N2 series

---

## TV signal processor-Teletext decoder with embedded $\mu$ -Controller

## TDA935X/6X/8X PS/N2 series

### FUNCTIONAL DESCRIPTION OF VIDEO PROCESSOR

#### Vision IF amplifier

The vision IF amplifier can demodulate signals with positive and negative modulation. The PLL demodulator is completely alignment-free.

The VCO of the PLL circuit is internal and the frequency is fixed to the required value by using the clock frequency of the  $\mu$ -Controller/Teletext decoder as a reference. The setting of the various frequencies (38, 38.9, 45.75 and 58.75 MHz) can be made via the control bits IFA-IFC in subaddress 27H. Because of the internal VCO the IF circuit has a high immunity to EMC interferences.

#### QSS Sound circuit

The sound IF amplifier is similar to the vision IF amplifier and has an external AGC decoupling capacitor.

The single reference QSS mixer is realised by a multiplier. In this multiplier the SIF signal is converted to the intercarrier frequency by mixing it with the regenerated picture carrier from the VCO. The mixer output signal is supplied to the output via a high-pass filter for attenuation of the residual video signals. With this system a high performance hi-fi stereo sound processing can be achieved.

The AM sound demodulator is realised by a multiplier. The modulated sound IF signal is multiplied in phase with the limited SIF signal. The demodulator output signal is supplied to the output via a low-pass filter for attenuation of the carrier harmonics. The AM signal is supplied to the output (AUDOUT/AMOUT) via the volume control.

Switching between the QSS output and AM output is made by means of the AM bit in subaddress 29H (see also Table 1).

#### FM demodulator

The FM demodulator is realised as narrow-band PLL with external loop filter, which provides the necessary selectivity without using an external band-pass filter. To obtain a good selectivity a linear phase detector and a constant input signal amplitude are required. For this reason the intercarrier signal is internally supplied to the demodulator via a gain controlled amplifier and AGC circuit. To improve the selectivity an internal bandpass filter is connected in front of the PLL circuit.

The nominal frequency of the demodulator is tuned to the required frequency (4.5/5.5/6.0/6.5 MHz) by means of a calibration circuit which uses the clock frequency of the  $\mu$ -Controller/Teletext decoder as a reference. The setting to the wanted frequency is realised by means of the control bits FMA/FMB in the control bit 29H.

From the output status bytes it can be read whether the PLL frequency is inside or outside the window and whether the PLL is in lock or not. With this information it is possible to make an automatic search system for the incoming sound frequency. This can be realised by means of a software loop which switches the demodulator to the various frequencies and then select the frequency on which a lock condition has been found.

The deemphasis output signal amplitude is independent of the TV standard and has the same value for a frequency deviation of  $\pm 25$  kHz at the 4.5 MHz standard and for a deviation of  $\pm 50$  KHz for the other standards.

TV signal processor-Teletext decoder with embedded  $\mu$ -Controller

TDA935X/6X/8X PS/N2 series

**Audio circuit and input signal selection**

The audio control circuit contains an audio switch with 1 external input and a volume control circuit. The selection of the various inputs is made by means of the ADX bit. In various versions the Automatic Volume Levelling (AVL) function can be activated. The pin to which the external capacitor has to be connected depends on the IC version. For the 90° types the capacitor is connected to the EW output pin. For the 110° types a choice must be made between the AVL function and a sub-carrier output for comb filter applications. This choice is made via the CBM0/1 bits (in subaddress 22H). When the AVL is active it automatically stabilises the audio output signal to a certain level.

It is possible to use the deemphasis pin as additional audio input. In that case the internal signal must, of course, be switched off. This can be realized by means of the sound mute bit (SM in subaddress 29H). When the IF circuit is switched to positive modulation the internal signal on the deemphasis pin is automatically muted.

**CVBS and Y/C input signal selection**

The circuit has 2 inputs for external CVBS signals and one input can also be used as one Y/C input (see Fig. 27).

It is possible to supply the selected CVBS signal to the demodulated IF video output pin. This mode is selected by means of the SVO bit in subaddress 22H. The vision IF amplifier is switched off in this mode.

The video ident circuit can be connected to the incoming 'internal' video signal or to the selected signal. This ident circuit is independent of the synchronisation and can be used to switch the time-constant of the horizontal PLL depending on the presence of a video signal (via the VID bit). In this way a very stable OSD can be realised.

The subcarrier output is combined with a 3-level output switch (0 V, 2.3 V and 4.5 V). The output level and the availability of the subcarrier signal is controlled by the CMB1 and CMB0 bits. The output can be used to switch sound traps etc. It is also possible to use this pin for the connection of the AVL capacitor or as AM output.

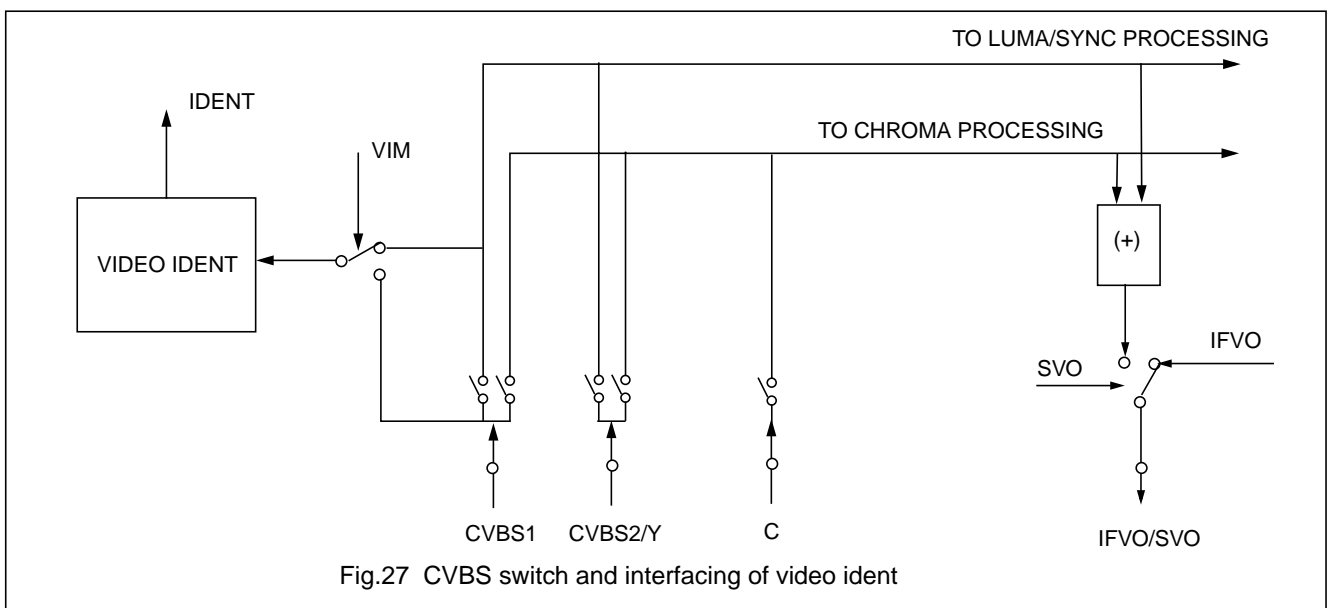

Fig.27 CVBS switch and interfacing of video ident

---

## TV signal processor-Teletext decoder with embedded $\mu$ -Controller TDA935X/6X/8X PS/N2 series

---

### Synchronisation circuit

The IC contains separator circuits for the horizontal and vertical sync pulses and a data-slicing circuit which extracts the digital teletext data from the analog signal.

The horizontal drive signal is obtained from an internal VCO which is running at a frequency of 25 MHz. This oscillator is stabilised to this frequency by using a 12 MHz signal coming from the reference oscillator of the  $\mu$ -Controller.

The horizontal drive is switched on and off via the soft start/stop procedure. This function is realised by means of variation of the  $T_{ON}$  of the horizontal drive pulses. In addition the horizontal drive circuit has a 'low-power start-up' function.

The vertical synchronisation is realised by means of a divider circuit. The vertical ramp generator needs an external resistor and capacitor. For the vertical drive a differential output current is available. The outputs must be DC coupled to the vertical output stage.

In the types which are intended for 90° picture tubes the following geometry parameters can be adjusted:

- Horizontal shift
- Vertical amplitude
- Vertical slope
- S-correction
- Vertical shift

The types which are intended to be used in combination with 110° picture tubes have an East-West control circuit in stead of the AVL function. The additional controls for these types are:

- EW width
- EW parabola width
- EW upper and lower corner parabola correction
- EW trapezium correction
- Vertical zoom
- horizontal parallelogram and bow correction.

When the vertical amplitude is compressed (zoom factor  $<1$ ) it is still possible to display the black current measuring lines in the overscan. This function is activated by means of the bit OSVE in subaddress 26H.

### Chroma, luminance and feature processing

The chroma band-pass and trap circuits (including the SECAM cloche filter) are realised by means of gyrators and are tuned to the right frequency by comparing the tuning frequency with the reference frequency of the colour decoder. The luminance delay line and the delay cells for the peaking circuit are also realised with gyrators.

The circuit contains the following picture improvement features:

- Peaking control circuit. The ratio of the positive and negative overshoots of the peaking can be adjusted by means of the bits RPO1/RPO0 in subaddress 2EH.
- Black stretch. This function corrects the black level for incoming signals which have a difference between the black level and the blanking level.

---

## TV signal processor-Teletext decoder with embedded $\mu$ -Controller TDA935X/6X/8X PS/N2 series

---

### Colour decoder

The ICs can decode PAL, SECAM and NTSC signals. The PAL/NTSC decoder does not need external reference crystals but has an internal clock generator which is stabilised to the required frequency by using the 12 MHz clock signal from the reference oscillator of the  $\mu$ -Controller.

Under bad-signal conditions (e.g. VCR-playback in feature mode), it may occur that the colour killer is activated although the colour PLL is still in lock. When this killing action is not wanted it is possible to overrule the colour killer by forcing the colour decoder to the required standard and to activate the FCO-bit (Forced Colour On) in subaddress 21H.

The Automatic Colour Limiting (ACL) circuit (switchable via the ACL bit in subaddress 20H) prevents that oversaturation occurs when PAL/NTSC signals with a high chroma-to-burst ratio are received. The ACL circuit is designed such that it only reduces the chroma signal and not the burst signal. This has the advantage that the colour sensitivity is not affected by this function.

The SECAM decoder contains an auto-calibrating PLL demodulator which has two references, viz: the divided 12 MHz reference frequency (obtained from the  $\mu$ -Controller) which is used to tune the PLL to the desired free-running frequency and the bandgap reference to obtain the correct absolute value of the output signal. The VCO of the PLL is calibrated during each vertical blanking period, when the IC is in search or SECAM mode.

The base-band delay line (TDA 4665 function) is integrated. This delay line is also active during NTSC to obtain a good suppression of cross colour effects. The demodulated colour difference signals are internally supplied to the delay line.

### RGB output circuit and black-current stabilization

In the RGB control circuit the signal is controlled on contrast, brightness and saturation. The ICs have a linear input for external RGB/YUV signals. Switching between RGB and the YUV mode can be realised via the YUV bit in subaddress 2BH. The signals for OSD and text are internally supplied to the control circuit. The output signal has an amplitude of about 2 V black-to-white at nominal input signals and nominal settings of the various controls.

To obtain an accurate biasing of the picture tube the 'Continuous Cathode Calibration' (CCC) system has been included in these ICs.

A black level off-set can be made with respect to the level which is generated by the black current stabilization system. In this way different colour temperatures can be obtained for the bright and the dark part of the picture. In the  $V_{g2}$  adjustment mode (AVG = 1) the black current stabilization system checks the output level of the 3 channels and indicates whether the black level of the highest output is in a certain window (WBC-bit) or below or above this window (HBC-bit). This indication can be read from the status byte 01 and can be used for automatic adjustment of the  $V_{g2}$  voltage during the production of the TV receiver. During this test the vertical scan remains active so that the indication of the 2 bits can be made visible on the TV screen.

The control circuit contains a beam current limiting circuit and a peak white limiting circuit. To prevent that the peak white limiting circuit reacts on the high frequency content of the video signal a low-pass filter is inserted in front of the peak detector.

During switch-off of the TV receiver a fixed beam current is generated by the black current control circuit. This current ensures that the picture tube capacitance is discharged. During the switch-off period the vertical deflection can be placed in an overscan position so that the discharge is not visible on the screen.

A wide blanking pulse can be activated in the RGB outputs by means of the HBL bit in subaddress 2BH.



## TV signal processor-Teletext decoder with embedded $\mu$ -Controller

## TDA935X/6X/8X PS/N2 series

### SOFTWARE CONTROL

The CPU communicates with the peripheral functions using Special function Registers (SFRs) which are addressed as RAM locations. The registers for the Teletext decoder appear as normal SFRs in the  $\mu$ -Controller memory map and are written to these functions by using a serial bus. This bus is controlled by dedicated hardware which uses a simple handshake system for software synchronisation.

For compatibility reasons and possible re-use of software blocks, the I<sup>2</sup>C-bus control for the TV processor is organised as in the stand-alone TV signal processors. The TV processor registers cannot be read, so when the content of these registers is needed in the software, a copy should be stored in Auxiliary RAM or Non Volatile RAM. The slave address of the TV signal processor is given in Fig.28.

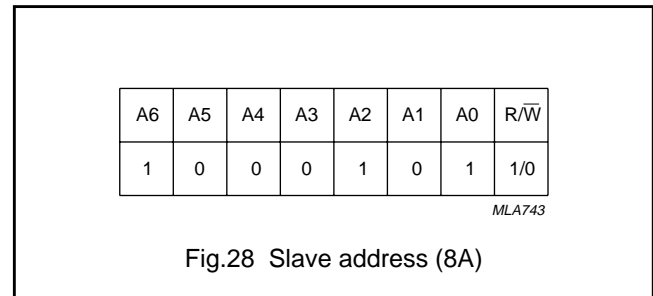

Valid subaddresses: 05H to 2EH, subaddress FE and FF are reserved for test purposes. Auto-increment mode available for subaddresses.

TV signal processor-Teletext decoder with  
embedded  $\mu$ -Controller

## TDA935X/6X/8X PS/N2 series

DESCRIPTION OF THE I<sup>2</sup>C-BUS SUBADDRESSES

Table 33 Inputs TV-processor

FUNCTION	SUBADDR (HEX)	DATA BYTE								POR Value
		D7	D6	D5	D4	D3	D2	D1	D0	
Off-set IF demodulator	05	0	0	A5	A4	A3	A2	A1	A0	20
Horizontal parallelogram <sup>(1)</sup>	06	0	0	A5	A4	A3	A2	A1	A0	20
Horizontal bow <sup>(1)</sup>	07	0	0	A5	A4	A3	A2	A1	A0	20
Hue	08	0	0	A5	A4	A3	A2	A1	A0	00
Horizontal shift (HS)	09	0	0	A5	A4	A3	A2	A1	A0	20
EW width (EW) <sup>(1)</sup>	0A	0	0	A5	A4	A3	A2	A1	A0	20
EW parabola/width (PW) <sup>(1)</sup>	0B	0	0	A5	A4	A3	A2	A1	A0	20
EW upper corner parabola <sup>(1)</sup>	0C	0	0	A5	A4	A3	A2	A1	A0	20
EW lower corner parabola <sup>(1)</sup>	0D	0	0	A5	A4	A3	A2	A1	A0	20
EW trapezium (TC) <sup>(1)</sup>	0E	0	0	A5	A4	A3	A2	A1	A0	20
Vertical slope (VS)	0F	0	0	A5	A4	A3	A2	A1	A0	20
Vertical amplitude (VA)	10	0	0	A5	A4	A3	A2	A1	A0	20
S-correction (SC)	11	0	0	A5	A4	A3	A2	A1	A0	20
Vertical shift (VSH)	12	0	0	A5	A4	A3	A2	A1	A0	20
Vertical zoom (VX) <sup>(1)</sup>	13	0	0	A5	A4	A3	A2	A1	A0	20
Black level offset R	14	0	0	A5	A4	A3	A2	A1	A0	20
Black level offset G	15	0	0	A5	A4	A3	A2	A1	A0	20
White point R	16	0	0	A5	A4	A3	A2	A1	A0	20
White point G	17	0	0	A5	A4	A3	A2	A1	A0	20
White point B	18	0	0	A5	A4	A3	A2	A1	A0	20
Peaking	19	PF1	PF0	A5	A4	A3	A2	A1	A0	20
Luminance delay time	1A	0	0	0	0	YD3	YD2	YD1	YD0	00
Brightness	1B	0	0	A5	A4	A3	A2	A1	A0	20
Saturation	1C	0	0	A5	A4	A3	A2	A1	A0	20
Contrast	1D	0	0	A5	A4	A3	A2	A1	A0	20
AGC take-over	1E	0	0	A5	A4	A3	A2	A1	A0	20
Volume control	1F	0	0	A5	A4	A3	A2	A1	A0	20
Colour decoder 0	20	CM3	CM2	CM1	CM0	MAT	MUS	ACL	CB	00
Colour decoder 1	21	0	0	0	0	0	0	BPS	FCO	00
AV-switch 0	22	0	0	SVO	CMB1	CMB0	INA	INB	0	00
AV-switch 1	23	0	0	0	0	0	0	0	RGBL	00
Synchronisation 0	24	0	HP2	FOA	FOB	POC	STB	VIM	VID	00
Synchronisation 1	25	0	0	FSL	OSO	FORF	FORS	DL	NCIN	00
Deflection	26	0	AFN	DFL	XDT	SBL	AVG	EVG	HCO <sup>(1)</sup>	00
Vision IF 0	27	IFA	IFB	IFC	VSW	MOD	AFW	IFS	STM	00
Vision IF 1	28	SIF	0	0	IFLH	0	AGC1	AGC0	FFI	00
Sound 0	29	AGN	SM1	FMWS	AM <sup>(3)</sup>	SM0	0	FMB	FMA	00
Control 0	2A	0	IE2	RBL	AKB	CL3	CL2	CL1	CL0	00
Control 1	2B	0	IVG	0	0	0	YUV	0	HBL <sup>(1)</sup>	00
Sound 1	2C	0	0	ADX	0	0	AVL <sup>(2)</sup>	QSS	0	00
Features 0	2D	0	0	0	0	0	0	0	BKS	00
Features 1	2E	0	BPB	RPO1	RPO0	0	0	0	0	00

## Note

1. These functions are only available in versions which have the East-West drive output.
2. The AVL function is only available in versions which have no East-West output or when the subcarrier output is used for the connection of the AVL capacitor (via the bits CMB1 and CMB0 in subaddress 22H).
3. Only available in types with QSS sound IF circuit and AM demodulator.

TV signal processor-Teletext decoder with  
embedded  $\mu$ -Controller

## TDA935X/6X/8X PS/N2 series

**Table 34** Outputs TV-processor

FUNCTION	SUBADDR	DATA BYTE							
		D7	D6	D5	D4	D3	D2	D1	D0
Output status bytes	00	POR	IFI	LOCK	SL	CD3	CD2	CD1	CD0
	01	XPR	NDF	FSI	IVW	WBC	HBC	BCF	IN2
	02	SUP	X	X	QSS	AFA	AFB	FMW	FML

**Explanation input control data TV-processor****Table 35** Off-set IF demodulator

DAC SETTING	CONTROL
0	negative correction
20	no correction
3F	positive correction

**Table 36** Horizontal parallelogram

DAC SETTING	CONTROL
0	screen top 0.5 $\mu$ s delayed and screen bottom 0.5 $\mu$ s advanced with respect to centre
20	no correction
3F	screen top 0.5 $\mu$ s advanced and screen bottom 0.5 $\mu$ s delayed with respect to centre

**Table 37** Horizontal bow

DAC SETTING	CONTROL
0	screen top and bottom 0.5 $\mu$ s delayed with respect to centre
20	no correction
3F	screen top and bottom 0.5 $\mu$ s advanced with respect to centre

**Table 38** Hue control

DAC SETTING	CONTROL
0	-45°
20	0°
3F	+45°

**Table 39** Horizontal shift

DAC SETTING	CONTROL
0	-2 $\mu$ s
20	0
3F	+2 $\mu$ s

**Table 40** EW width

DAC SETTING	CONTROL
0	output current 700 $\mu$ A
3F	output current 0 $\mu$ A

**Table 41** EW parabola/width

DAC SETTING	CONTROL
0	output current 0 $\mu$ A
3F	output current 440 $\mu$ A at top and bottom of screen

**Table 42** EW upper/lower corner parabola

DAC SETTING	CONTROL
0	output current +76 $\mu$ A
11	output current 0 $\mu$ A
3F	output current -207 $\mu$ A

**Table 43** EW trapezium

DAC SETTING	CONTROL
0	output current at top of screen 100 $\mu$ A lower than at bottom
20	no correction
3F	output current at top of screen 100 $\mu$ A higher than at bottom

# TV signal processor-Teletext decoder with embedded $\mu$ -Controller

## TDA935X/6X/8X PS/N2 series

**Table 44** Vertical slope

DAC SETTING	CONTROL
0	correction -20%
20	no correction
3F	correction +20%

**Table 45** Vertical amplitude

DAC SETTING	CONTROL
0	amplitude 80%
20	amplitude 100%
3F	amplitude 120%

**Table 46** S-correction

DAC SETTING	CONTROL
0	correction -10%
0E	no correction
3F	correction 25%

**Table 47** Vertical shift

DAC SETTING	CONTROL
0	shift -5%
20	no correction
3F	shift +5%

**Table 48** Vertical zoom

DAC SETTING	CONTROL
0	amplitude 75%
20	amplitude 100%
3F	amplitude 138%

**Table 49** Black level off-set R/G

DAC SETTING	CONTROL
0	off-set of -160 mV
20	no off-set
3F	off-set of +160 mV

**Table 50** White point R/G/B

DAC SETTING	CONTROL
0	gain -3 dB
20	no correction
3F	gain +3 dB

**Table 51** Peaking centre frequency

PF1	PF0	CENTRE FREQUENCY
0	0	2.7 MHz
0	1	3.1 MHz
1	0	3.5 MHz
1	1	spare

**Table 52** Peaking control (overshoot in direction 'black')

DAC SETTING	CONTROL
0	depeaking (overshoot -22%)
10	no peaking
3F	overshoot 80%

**Table 53** Y-delay adjustment; note 1

YD0 to YD3	Y-DELAY
YD3	$YD3 \times 160 \text{ ns} +$
YD2	$YD2 \times 80 \text{ ns} +$
YD1	$YD1 \times 80 \text{ ns} +$
YD0	$YD0 \times 40 \text{ ns}$

**Note**

- For an equal delay of the luminance and chrominance signal the delay must be set at a value of 160 ns. This is only valid for a CVBS signal without group delay distortions.

**Table 54** Brightness control

DAC SETTING	CONTROL
0	correction -0.7V
20	no correction
3F	correction +0.7V

**Table 55** Saturation control

DAC SETTING	CONTROL
0	colour off (-52 dB)
17	saturation nominal
3F	saturation +300%

**Table 56** Contrast control

DAC SETTING	CONTROL
0	RGB amplitude -14 dB
20	RGB amplitude nominal
3F	RGB amplitude +6 dB

# TV signal processor-Teletext decoder with embedded $\mu$ -Controller

## TDA935X/6X/8X PS/N2 series

**Table 57** AGC take-over

DAC SETTING	CONTROL
0	tuner take-over at IF input signal of 0.4 mV
3F	tuner take-over at IF input signal of 80 mV

**Table 58** Volume control

DAC SETTING	CONTROL
0	attenuation 80 dB
3F	no attenuation

**Table 59** Colour decoder mode, note 1

CM3	CM2	CM1	CM0	DECODER MODE	FREQ
0	0	0	0	PAL/NTSC/SECAM	A
0	0	0	1	PAL/SECAM	A
0	0	1	0	PAL	A
0	0	1	1	NTSC	A
0	1	0	0	SECAM	
0	1	0	1	PAL/NTSC	B
0	1	1	0	PAL	B
0	1	1	1	NTSC	B
1	0	0	0	PAL/NTSC/SECAM	ABCD
1	0	0	1	PAL/NTSC	C
1	0	1	0	PAL	C
1	0	1	1	NTSC	C
1	1	0	0	PAL/NTSC (Tri-Norma)	BCD
1	1	0	1	PAL/NTSC	D
1	1	1	0	PAL	D
1	1	1	1	NTSC	D

**Note**

1. The decoder frequencies for the various standards are obtained from an internal clock generator which is synchronised by a 12 MHz reference signal which is obtained from the  $\mu$ -Controller clock generator.

These frequencies are:

- a) A: 4.433619 MHz
- b) B: 3.582056 MHz (PAL-N)
- c) C: 3.575611 MHz (PAL-M)
- d) D: 3.579545 MHz (NTSC-M)

**Table 60** PAL-SECAM/NTSC matrix

MAT	MATRIX POSITION
0	adapted to standard
1	PAL matrix

**Table 61** NTSC matrix

MUS	MATRIX POSITION
0	Japanese matrix
1	USA matrix

**Table 62** Automatic colour limiting

ACL	COLOUR LIMITING
0	not active
1	active

**Table 63** Chroma bandpass centre frequency

CB	CENTRE FREQUENCY
0	$F_{SC}$
1	$1.1 \times F_{SC}$

**Table 64** Bypass of chroma base-band delay line

BPS	DELAY LINE MODE
0	active
1	bypassed

**Table 65** Forced Colour-On

FCO	CONDITION
0	off
1	on

**Table 66** Selected video out

SVO	CONDITION
0	IF video available at output
1	selected CVBS available at output

**Table 67** Condition AVL/SNDIF/REFO

CMB1	CMB0	CONDITION
0	0	AVL/SNDIF active (depends on SIF bit)
0	1	output voltage 2.3 V + subcarrier;
1	0	output voltage low (<0.8 V)
1	1	output voltage high (>4.5V)

# TV signal processor-Teletext decoder with embedded $\mu$ -Controller

## TDA935X/6X/8X PS/N2 series

**Table 68** Source select

INA	INB	INC	SELECTED SIGNALS
0	0	0	CVBS1
0	1	0	CVBS2
1	0	0	Y/C

**Table 69** Blanking of RGB outputs

RGBL	CONDITION
0	normal operation
1	RGB outputs blanked continuously

**Table 70** Synchronization of OSD/TEXT display

HP2	$\mu$ -CONTROLLER COUPLED TO
0	$\phi$ 1 loop
1	$\phi$ 2 loop

**Table 71** Phase 1 ( $\phi_1$ ) time constant

FOA	FOB	MODE
0	0	normal
0	1	slow
1	0	slow/fast
1	1	fast

**Table 72** Synchronization mode

POC	MODE
0	active
1	not active

**Table 73** Stand-by

STB	MODE
0	stand-by
1	normal

**Table 74** Video ident mode

VIM	MODE
0	ident coupled to internal CVBS (pin 40)
1	ident coupled to selected CVBS

**Table 75** Video ident mode

VID	VIDEO IDENT MODE
0	$\phi$ 1 loop switched on and off
1	not active

**Table 76** Forced slicing level for vertical sync

FSL	SLICING LEVEL
0	slicing level dependent on noise detector
1	fixed slicing level of 60%

**Table 77** Switch-off in vertical overscan

OSO	MODE
0	Switch-off undefined
1	Switch-off in vertical overscan

**Table 78** Forced field frequency

FORF	FORS	FIELD FREQUENCY
0	0	auto (60 Hz when line not in sync)
0	1	60 Hz
1	0	keep last detected field frequency
1	1	auto (50 Hz when line not in sync)

**Table 79** Interlace

DL	STATUS
0	interlace
1	de-interlace

**Table 80** Vertical divider mode

NCIN	VERTICAL DIVIDER MODE
0	normal operation
1	switched to search window

**Table 81** AFC switch

AFN	MODE
0	normal operation
1	AFC not active

**Table 82** Disable flash protection

DFL	MODE
0	flash protection active
1	flash protection disabled

# TV signal processor-Teletext decoder with embedded $\mu$ -Controller

## TDA935X/6X/8X PS/N2 series

**Table 83** X-ray detection

XDT	MODE
0	protection mode, when a too high EHT is detected the receiver is switched to stand-by and the XPR-bit is set to 1
1	detection mode, the receiver is not switched to stand-by and only the XPR-bit is set to 1

**Table 84** Service blanking

SBL	SERVICE BLANKING MODE
0	off
1	on

**Table 85** Adjustment  $V_{g2}$  voltage

AVG	MODE
0	normal operation
1	$V_{g2}$ adjustment (WBC and HBC bits in output byte 01 can be read)

**Table 86** Enable vertical guard (RGB blanking)

EVG	VERTICAL GUARD MODE
0	not active
1	active

**Table 87** EHT tracking mode

HCO	TRACKING MODE
0	EHT tracking only on vertical
1	EHT tracking on vertical and EW

**Table 88** PLL demodulator frequency adjust

IFA	IFB	IFC	IF FREQUENCY
0	0	0	58.75 MHz
0	0	1	45.75 MHz
0	1	0	38.90 MHz
0	1	1	38.00 MHz
1	0	0	33.40 MHz
1	1	0	33.90 MHz

**Table 89** Video mute

VSW	STATE
0	normal operation
1	IF-video signal switched off

**Table 90** Modulation standard

MOD	MODULATION
0	negative
1	positive

**Table 91** AFC window

AFW	AFC WINDOW
0	normal
1	enlarged

**Table 92** IF sensitivity

IFS	IF SENSITIVITY
0	normal
1	reduced

**Table 93** Search tuning mode

STM	MODE
0	normal operation
1	reduced sensitivity of video indent circuit

**Table 94** Selection external input for sound IF circuit

SIF	MODE
0	IF input not selected
1	IF input selected (see also table 1)

**Table 95** Calibration of IF PLL demodulator

IFLH	MODE
0	calibration system active
1	calibration system not active

**Table 96** IF AGC speed

AGC1	AGC0	AGC SPEED
0	0	$0.7 \times \text{norm}$
0	1	norm
1	0	$3 \times \text{norm}$
1	1	$6 \times \text{norm}$

**Table 97** Fast filter IF-PLL

FFI	CONDITION
0	normal time constant
1	increased time constant

TV signal processor-Teletext decoder with  
embedded  $\mu$ -Controller

## TDA935X/6X/8X PS/N2 series

**Table 98** Gain FM demodulator

AGN	MODE
0	normal operation
1	gain +6 dB, to be used for the demodulation of mono signals in the NTSC system

**Table 99** Sound mute

SM1	SM0	CONDITION
0	1	see note 1
1	0	mute on
1	1	mute off

**Note**

1. The mute is activated when the digital acquisition help is out-of-window.

**Table 100** Window selection of Narrow-band sound PLL

FMWS	FUNCTION
0	small window
1	large window

**Table 101** Selection QSS out or AM out

AM	MODE
0	QSS output selected
1	AM output selected

**Table 102** Nominal frequency FM demodulator

FMB	FMA	FREQUENCY
0	0	5.5 MHz
0	1	6.0 MHz
1	0	4.5 MHz
1	1	6.5 MHz

**Table 103** Enable fast blanking ext.RGB/YUV

IE2	FAST BLANKING
0	not active
1	active

**Table 104** RGB blanking

RBL	RGB BLANKING
0	not active
1	active

**Table 105** Black current stabilization

AKB	MODE
0	active
1	not active

**Table 106** Cathode drive level (15 steps; 3.5 V/step)

CL3	CL2	CL1	CL0	SETTING CATHODE DRIVE AMPLITUDE; NOTE 1
0	0	0	0	50 V <sub>BL-WH</sub>
0	1	1	1	75 V <sub>BL-WH</sub>
1	1	1	1	95 V <sub>BL-WH</sub>

**Note**

1. The given values are valid for the following conditions:
  - a) - Nominal CVBS input signal
  - b) - Nominal settings for contrast, WPA and peaking
  - c) - Black- and blue-stretch switched-off
  - d) - Gain of output stage such that no clipping occurs
  - e) - Beam current limiting not active
  - f) The tolerance on these values is about  $\pm 3$  V.

**Table 107** Activation vertical guard

IVG	MODE
0	vertical guard connected to black current input
1	vertical guard connected to BCL input and "Peak-White-Limiting" disabled

**Table 108** RGB / YUV switch

YUV	STATUS
0	RGB input activated
1	YUV input activated

**Table 109** RGB blanking mode (110° types)

HBL	MODE
0	normal blanking (horizontal flyback)
1	wide blanking



TV signal processor-Teletext decoder with  
embedded  $\mu$ -Controller

## TDA935X/6X/8X PS/N2 series

**Table 110** Audio signal selection

ADX	SELECTED SIGNAL
0	internal audio signal
1	external audio signal

**Table 111** Auto Volume Levelling

AVL	MODE
0	not active
1	active

**Table 112** Mode of Quasi Split Sound amplifier

QSS	MODE
0	QSS amplifier not active,
1	QSS amplifier active

**Table 113** Black stretch

BKS	BLACK STRETCH MODE
0	off
1	on

**Table 114** Bypass of sound bandpass filter

BPB	CONDITION
0	normal operation
1	sound bandpass filter bypassed

**Table 115** Ratio pre- and overshoot

RPO1	RPO0	RATIO PRE-/OVERSHOOT
0	0	1 : 1
0	1	1 : 1.25
1	0	1 : 1.5
1	1	1 : 1.8

**Explanation output control data TV-processor****Table 116** Power-on-reset

POR	MODE
0	normal
1	power-down

**Table 117** Output video identification

IFI	VIDEO SIGNAL
0	no video signal identified
1	video signal identified

**Table 118** IF-PLL lock indication

LOCK	INDICATION
0	not locked
1	locked

**Table 119** Phase 1 ( $\phi_1$ ) lock indication

SL	INDICATION
0	not locked
1	locked

**Table 120** Colour decoder mode, note 1

CD3	CD2	CD1	CD0	STANDARD
0	0	0	0	no colour standard identified
0	0	0	1	NTSC with freq. A
0	0	1	0	PAL with freq. A
0	0	1	1	NTSC with freq. B
0	1	0	0	PAL with freq. B
0	1	0	1	NTSC with freq. C
0	1	1	0	PAL with freq. C
0	1	1	1	NTSC with freq. D
1	0	0	0	PAL with freq. D
1	0	1	0	SECAM

**Note**

1. The values for the various frequencies can be found in the note of table 59.

**Table 121** X-ray protection

XPR	OVERVOLTAGE
0	no overvoltage detected
1	overvoltage detected

TV signal processor-Teletext decoder with embedded  $\mu$ -Controller TDA935X/6X/8X PS/N2 series

**Table 122** Output vertical guard

NDF	VERTICAL OUTPUT STAGE
0	OK
1	failure

**Table 123** Field frequency indication

FSI	FREQUENCY
0	50 Hz
1	60 Hz

**Table 124** Condition vertical divider

IWV	STANDARD VIDEO SIGNAL
0	no standard video signal
1	standard video signal (525 or 625 lines)

**Table 125** Indication output black level in/out window

WBC	CONDITION
0	black current stabilisation outside window
1	black current stabilisation inside window

**Table 126** Indication output black level

HBC	CONDITION
0	black current stabilisation below window
1	black current stabilisation above window

**Table 127** Condition black current loop

BCF	CONDITION
0	black current loop is stabilised
1	black current loop is not stabilised

**Table 128** Indication RGB-2 input condition

IN2	RGB INSERTION
0	no
1	yes

**Table 129** Supply voltage indication

SUP	CONDITION
0	supply voltage (8 Volt) not present
1	supply voltage (8 Volt) present

**Table 130** Version indication

QSS	IC VERSION
0	version with intercarrier mono sound circuit
1	version with QSS-IF circuit

**Table 131** AFC output

AFA	AFB	CONDITION
0	0	outside window; RF too low
0	1	outside window; RF too high
1	0	in window; below reference
1	1	in window; above reference

**Table 132** Indication FM-PLL in/out window

FMW	CONDITION
0	FM-PLL in window
1	FM-PLL out of window

**Table 133** Indication FM-PLL in/out lock

FML	CONDITION
0	FM-PLL out of lock
1	FM-PLL locked

TV signal processor-Teletext decoder with  
embedded  $\mu$ -Controller

## TDA935X/6X/8X PS/N2 series

**LIMITING VALUES**

In accordance with the Absolute Maximum Rating System (IEC 134).

SYMBOL	PARAMETER	CONDITIONS	MIN.	MAX.	UNIT
$V_P$	supply voltage		–	9	V
$V_{DD}$	supply voltage (all digital supplies)		–0.5	5.0	V
$V_I$	digital inputs	note 1	–0.5	$V_{DD} + 0.5$	V
$V_O$	digital outputs	note 1	–0.5	$V_{DD} + 0.5$	V
$I_O$	output current (each output)		–	$\pm 10$	mA
$I_{I/OK}$	DC input or output diode current		–	$\pm 20$	mA
$T_{stg}$	storage temperature		–25	+150	$^{\circ}\text{C}$
$T_{amb}$	operating ambient temperature		0	70	$^{\circ}\text{C}$
$T_{sol}$	soldering temperature	for 5 s	–	260	$^{\circ}\text{C}$
$T_j$	operating junction temperature		–	150	$^{\circ}\text{C}$
$V_{es}$	electrostatic handling	HBM; all pins; notes 2 and 3	–2000	+2000	V
		MM; all pins; notes 2 and 4	–300	+300	V

**Notes**

1. This maximum value has an absolute maximum of 5.5 V independent of  $V_{DD}$ .
2. All pins are protected against ESD by means of internal clamping diodes.
3. Human Body Model (HBM):  $R = 1.5 \text{ k}\Omega$ ;  $C = 100 \text{ pF}$ .
4. Machine Model (MM):  $R = 0 \text{ }\Omega$ ;  $C = 200 \text{ pF}$ .

**THERMAL CHARACTERISTICS**

SYMBOL	PARAMETER	VALUE	UNIT
$R_{th\ j-a}$	thermal resistance from junction to ambient in free air	35	K/W

**QUALITY SPECIFICATION**

In accordance with "SNW-FQ-611E".

**Latch-up**At an ambient temperature of 70  $^{\circ}\text{C}$  all pins meet the following specification:

- $I_{trigger} \geq 100 \text{ mA}$  or  $\geq 1.5V_{DD(max)}$
- $I_{trigger} \leq -100 \text{ mA}$  or  $\leq -0.5V_{DD(max)}$ .

# TV signal processor-Teletext decoder with embedded $\mu$ -Controller

## TDA935X/6X/8X PS/N2 series

### CHARACTERISTICS OF MICRO-COMPUTER AND TEXT DECODER

$V_{DD} = 3.3 \text{ V} \pm 10\%$ ;  $V_{SS} = 0 \text{ V}$ ;  $T_{amb} = -20 \text{ to } +70 \text{ }^\circ\text{C}$ ; unless otherwise specified

NUMBER	PARAMETER	CONDITIONS	MIN.	TYP.	MAX.	UNIT
<b>Supplies</b>						
VM.1.1	supply voltage ( $V_{DDA/P/C}$ )		3.0	3.3	3.6	V
VM.1.2	periphery supply current ( $I_{DDP}$ )	note 1	1	–	–	mA
VM.1.3	core supply current ( $I_{DDC}$ )		–	15	tbf	mA
VM.1.4	analog supply current ( $I_{DDA}$ )		–	45	tbf	mA
<b>Digital inputs</b>						
RESET						
I.1.1	low level input voltage		–	–	0.8	V
I.1.2	high level input voltage		2.0	–	5.5	V
I.1.3	hysteresis of Schmitt Trigger input		0.4	–	0.7	V
I.1.4	input leakage current	$V_I = 0$	–	–	1	$\mu\text{A}$
I.1.5	equivalent pull down resistance	$V = V_{DD}$	–	33	–	$\text{k}\Omega$
I.1.6	capacitance of input pin		–	–	10	pF
<b>Digital input/outputs</b>						
P1.0 TO P1.3, P2.0 TO P2.6 AND P3.0 TO P3.3						
IO.1.1	low level input voltage		–	–	0.8	V
IO.1.2	high level input voltage		2.0	–	5.5	V
IO.1.3	hysteresis of Schmitt Trigger input		0.4	–	0.7	V
IO.1.4	low level output voltage	$I_{OL} = 4 \text{ mA}$	–	–	0.4	V
IO.1.5	high level output voltage	open drain	–	–	5.5	V
IO.1.6	high level output voltage	$I_{OH} = 4 \text{ mA}$	2.4	–	–	V
IO.1.7	output rise time (push-pull only) 10% to 90%	load 100 pF	–	16	–	ns
IO.1.8	output fall time 10% to 90%	load 100pF	–	14	–	ns
IO.1.9	load capacitance		–	–	100	pF
IO.1.10	capacitance of input pin		–	–	10	pF

# TV signal processor-Teletext decoder with embedded $\mu$ -Controller

## TDA935X/6X/8X PS/N2 series

NUMBER	PARAMETER	CONDITIONS	MIN.	TYP.	MAX.	UNIT
P0.5 AND P0.6						
IO.2.1	low level input voltage		–	–	0.8	V
IO.2.2	high level input voltage		2.0	–	5.5	V
IO.2.3	hysteresis of Schmitt Trigger input		0.4	–	0.7	V
IO.2.4	low level output voltage	$I_{OL} = 8\text{mA}$	–	–	0.4	V
IO.2.5	high level output voltage	open drain	–	–	5.5	V
IO.2.6	high level output voltage	$I_{OH} = 8\text{mA}$	2.4	–	–	V
IO.2.7	output rise time (push-pull only) 10% to 90%	load 100 pF	–	16	–	ns
IO.2.8	output fall time 10% to 90%	load 100pF	–	14	–	ns
IO.2.9	load capacitance		–	–	100	pF
IO.2.10	capacitance of input pin		–	–	10	pF
P1.6 AND P1.7						
IO.3.1	low level input voltage ( $V_{IL}$ )		–	–	1.5	V
IO.3.2	high level input voltage ( $V_{IH}$ )		3.0	–	5.5	V
IO.3.3	hysteresis of Schmitt-trigger input		0.2	–	–	V
IO.3.4	low level output voltage	sink current 8mA	0	–	0.4	V
IO.3.5	high level output voltage	open drain	–	–	5.5	V
IO.3.6	output fall time ( $V_{IH}$ to $V_{IL}$ for $C_L$ )		$20+0.1 \times C_L$	–	250	ns
IO.3.7	bus load capacitance		10	–	400	pF
IO.3.8	capacitance of IO pin		–	–	10	pF
<b>Crystal oscillator</b>						
OSCIN; NOTE 2						
X.1.1	resonator frequency		–	12	–	MHz
X.1.2	input capacitance ( $C_i$ )		–	4.0	–	pF
X.1.3	output capacitance ( $C_o$ )		–	5.0	–	pF
X.1.4	$C_{x1} = C_{x2}$		12	–	56	pF
X.1.5	$R_i$ (crystal)		–	–	100	$\Omega$

**Note**

- Peripheral current is dependent on external components and voltage levels on I/Os
- The simplified circuit diagram of the oscillator is given in Fig.29.

A suitable crystal for this oscillator is the Saronix type 9922 520 00169. The nominal tuning of the crystal is important to obtain a symmetrical catching range for the PLL in the colour decoder. This tuning can be adapted by means of the values of the capacitors  $C_{x1}$  and  $C_{x2}$  in Fig.29. Good results were obtained with capacitor values of 39 pF, however, for a new application the optimum value should be determined by checking the symmetry of the catching range of the colour decoder.

TV signal processor-Teletext decoder with  
embedded  $\mu$ -Controller

## TDA935X/6X/8X PS/N2 series

**CHARACTERISTICS OF TV-PROCESSORS** $V_P = 5\text{ V}$ ;  $T_{amb} = 25\text{ }^\circ\text{C}$ ; unless otherwise specified.

NUMBER	PARAMETER	CONDITIONS	MIN.	TYP.	MAX.	UNIT
<b>Supplies</b>						
MAIN SUPPLY; NOTE 1						
V.1.1	supply voltage		7.2	8.0	8.4	V
V.1.2	total supply current		–	135	–	mA
V.1.4	total power dissipation		–	1085	–	mW
<b>IF circuit</b>						
VISION IF AMPLIFIER INPUTS						
M.1.1	input sensitivity (RMS value)	note 2 $f_i = 38.90\text{ MHz}$	–	75	150	$\mu\text{V}$
M.1.2		$f_i = 45.75\text{ MHz}$	–	75	150	$\mu\text{V}$
M.1.3		$f_i = 58.75\text{ MHz}$	–	75	150	$\mu\text{V}$
M.1.4	input resistance (differential)	note 3	–	2	–	k $\Omega$
M.1.5	input capacitance (differential)	note 3	–	3	–	pF
M.1.6	gain control range		64	–	–	dB
M.1.7	maximum input signal (RMS value)		150	–	–	mV
PLL DEMODULATOR; NOTES 4 AND 5						
M.2.1	Free-running frequency of VCO	PLL not locked, deviation from nominal setting	–500	–	+500	kHz
M.2.2	Catching range PLL	without SAW filter	–	$\pm 1$	–	MHz
M.2.3	delay time of identification	via LOCK bit	–	–	20	ms
VIDEO AMPLIFIER OUTPUT; NOTES 7 AND 8						
M.3.1	zero signal output level	negative modulation; note 9	–	4.7	–	V
M.3.2		positive modulation; note 9	–	2.0	–	V
M.3.3	top sync level	negative modulation	1.9	2.1	2.3	V
M.3.4	white level	positive modulation	–	4.5	–	V
M.3.5	difference in amplitude between negative and positive modulation		–	0	15	%
M.3.6	video output impedance		–	50	–	$\Omega$
M.3.7	internal bias current of NPN emitter follower output transistor		1.0	–	–	mA
M.3.8	maximum source current		–	–	5	mA
M.3.9	bandwidth of demodulated output signal	at –3 dB	6	7	–	MHz
M.3.10	differential gain	note 10	–	2	5	%
M.3.11	differential phase	notes 10 and 6	–	–	5	deg

TV signal processor-Teletext decoder with  
embedded  $\mu$ -Controller

## TDA935X/6X/8X PS/N2 series

NUMBER	PARAMETER	CONDITIONS	MIN.	TYP.	MAX.	UNIT
VIDEO AMPLIFIER (CONTINUED)						
M.3.12	video non-linearity	note 11	–	–	5	%
M.3.13	white spot clamp level		–	5.3	–	V
M.3.14	noise inverter clamping level	note 12	–	1.5	–	V
M.3.15	noise inverter insertion level (identical to black level)	note 12	–	2.8	–	V
M.3.16	intermodulation blue	notes 6 and 13 $V_o = 0.92$ or $1.1$ MHz	60	66	–	dB
M.3.17		$V_o = 2.66$ or $3.3$ MHz	60	66	–	dB
M.3.18	yellow	$V_o = 0.92$ or $1.1$ MHz	56	62	–	dB
M.3.19		$V_o = 2.66$ or $3.3$ MHz	60	66	–	dB
M.3.20	signal-to-noise ratio	notes 6 and 14 weighted	56	60	–	dB
M.3.21		unweighted	49	53	–	dB
M.3.22	residual carrier signal	note 6	–	5.5	–	mV
M.3.23	residual 2nd harmonic of carrier signal	note 6	–	2.5	–	mV
IF AND TUNER AGC; NOTE 15						
<i>Timing of IF-AGC</i>						
M.4.1	modulated video interference	30% AM for 1 mV to 100 mV; 0 to 200 Hz (system B/G)	–	–	10	%
M.4.2	response time to IF input signal amplitude increase of 52 dB	positive and negative modulation	–	2	–	ms
M.4.3	response to an IF input signal amplitude decrease of 52 dB	negative modulation	–	50	–	ms
M.4.4		positive modulation	–	100	–	ms
<i>Tuner take-over adjustment (via I<sup>2</sup>C-bus)</i>						
M.5.1	minimum starting level for tuner take-over (RMS value)		–	0.4	0.8	mV
M.5.2	maximum starting level for tuner take-over (RMS value)		80	150	–	mV
<i>Tuner control output</i>						
M.6.1	maximum tuner AGC output voltage	maximum tuner gain; note 3	–	–	8	V
M.6.2	output saturation voltage	minimum tuner gain; $I_o = 2$ mA	–	–	300	mV
M.6.3	maximum tuner AGC output swing		5	–	–	mA
M.6.4	leakage current RF AGC		–	–	1	$\mu$ A
M.6.5	input signal variation for complete tuner control		0.5	2	4	dB

TV signal processor-Teletext decoder with  
embedded  $\mu$ -Controller

## TDA935X/6X/8X PS/N2 series

NUMBER	PARAMETER	CONDITIONS	MIN.	TYP.	MAX.	UNIT
AFC OUTPUT (VIA I <sup>2</sup> C-BUS); NOTE 16						
M.7.1	AFC resolution		–	2	–	bits
M.7.2	window sensitivity		–	125	–	kHz
M.7.3	window sensitivity in large window mode		–	275	–	kHz
VIDEO IDENTIFICATION OUTPUT (VIA IFI BIT IN OUTPUT BYTE 00)						
M.8.1	delay time of identification after the AGC has stabilized on a new transmitter		–	–	10	ms



TV signal processor-Teletext decoder with  
embedded  $\mu$ -Controller

## TDA935X/6X/8X PS/N2 series

NUMBER	PARAMETER	CONDITIONS	MIN.	TYP.	MAX.	UNIT
<b>QSS Sound IF circuit</b>						
SOUND IF AMPLIFIER						
Q.1.1	input sensitivity (RMS value)	FM mode (-3 dB)	-	30	70	$\mu$ V
Q.1.2		AM mode (-3 dB)	-	60	100	$\mu$ V
Q.1.3	maximum input signal (RMS value)	FM mode	50	70	-	mV
Q.1.4		AM mode	80	140	-	mV
Q.1.5	input resistance (differential)	note 3	-	2	-	k $\Omega$
Q.1.6	input capacitance (differential)	note 3	-	3	-	pF
Q.1.7	gain control range		64	-	-	dB
Q.1.8	crosstalk attenuation between SIF and VIF input		50	-	-	dB
SOUND IF INTERCARRIER OUTPUT; WITH AM = 0						
Q.2.1	output signal amplitude (RMS value)	SC-1; sound carrier 2 off	75	100	125	mV
Q.2.2	bandwidth (-3 dB)		7.5	10	-	MHz
Q.2.3	residual IF sound carrier (RMS value)		-	2	-	mV
Q.2.4	output resistance		-	300	-	$\Omega$
Q.2.5	DC output voltage		-	2.5	-	V
Q.2.6	internal bias current of emitter follower		-	1.0	-	mA
Q.2.7	maximum AC and DC sink current		-	1.0	-	mA
Q.2.8	maximum AC and DC source current		-	1.0	-	mA
Q.2.9	weighted S/N ratio (SC1/SC2). Ratio of PC/SC1 at vision IF input of 40 dB or higher, note 17	black picture	53/48	58/55	-	dB
Q.2.10		white picture	52/47	55/53	-	dB
Q.2.11		6 kHz sinewave (black-to-white modulation)	44/42	48/46	-	dB
Q.2.12		250 kHz sine wave (black-to-white modulation)	44/25	48/30	-	dB
Q.2.13		sound carrier subharmonics (f=2.75 MHz $\pm$ 3 kHz)	45/44	51/50	-	dB
Q.2.14		sound carrier subharmonics (f=2.87 MHz $\pm$ 3 kHz)	46/45	52/51	-	dB

TV signal processor-Teletext decoder with  
embedded  $\mu$ -Controller

## TDA935X/6X/8X PS/N2 series

NUMBER	PARAMETER	CONDITIONS	MIN.	TYP.	MAX.	UNIT
AM SOUND OUTPUT; DEPENDING ON SETTING OF CMB0/CMB1 AND AM BITS						
Q.3.1	AF output signal amplitude (RMS value)	54% modulation	400	500	600	mV
Q.3.2	total harmonic distortion	54% modulation	–	0.5	1.0	%
Q.3.21	total harmonic distortion	80% modulation	–	2.0	5.0	%
Q.3.3	AF bandwidth	–3 dB	100	125	–	kHz
Q.3.4	weighted signal-to-noise ratio		47	53	–	dB
Q.3.5	DC output voltage		–	2.5	–	V
Q.3.6	power supply ripple rejection		–	40	–	dB
<b>FM demodulator and audio amplifier</b>						
FM-PLL DEMODULATOR; NOTE 18						
G.1.2	gain control range AGC amplifier		26	30	–	dB
G.1.3	catching range PLL	note 19	–	$\pm 225$	–	kHz
G.1.4	maximum phase detector output current		–	$\pm 100$	–	$\mu$ A
G.1.5	VCO steepness $\Delta f_{FM}/\Delta V_C (K_0)$		–	3.3	–	MHz/V
G.1.6	phase detector steepness $\Delta I_C/\Delta \phi_{VFM} (K_D)$		–	9	–	$\mu$ A/rad
G.1.7	AM rejection	note 20	40	46	–	dB
EXTERNAL SOUND IF INPUT (SNDIF, WHEN SELECTED)						
G.1.8	input limiting for lock-in of PLL (RMS value)		–	1	2	mV
G.1.9	input resistance	note 3	–	50	–	k $\Omega$
G.1.10	input capacitance	note 3	–	–	1.0	pF
DE-EMPHASIS OUTPUT; NOTE 22						
G.2.1	output signal amplitude (RMS value)	notes 19 and 21	–	500	–	mV
G.2.2	output resistance		–	15	–	k $\Omega$
G.2.3	DC output voltage		–	3.2	–	V
G.2.31	signal-to-noise ratio (RMS value)	note 23	–	50	–	dB
AUDIO INPUT VIA DEEMPHASIS OUTPUT; NOTE 22						
G.2.4	input signal amplitude (RMS value)		–	500	–	mV
G.2.5	input resistance		–	15	–	k $\Omega$
G.2.6	voltage gain between input and output	maximum volume	–	9	–	dB

TV signal processor-Teletext decoder with  
embedded  $\mu$ -Controller

## TDA935X/6X/8X PS/N2 series

NUMBER	PARAMETER	CONDITIONS	MIN.	TYP.	MAX.	UNIT
<b>Audio Amplifier</b>						
AUDIO OUTPUT OR VOLUME CONTROLLED AM-OUT						
A.1.1	controlled output signal amplitude (RMS value)	-6 dB; nominal audio input signal	500	700	900	mV
A.1.2	output resistance		-	500	-	$\Omega$
A.1.3	DC output voltage		-	3.6	-	V
A.1.4	total harmonic distortion	note 24	-	-	0.5	%
A.1.6	power supply rejection	note 6	-	25	-	dB
A.1.7	internal signal-to-noise ratio	note 6 + 23 + 26	-	50	-	dB
A.1.8	external signal-to-noise ratio	note 6 + 26	-	60	-	dB
A.1.10	control range	see also Fig.30	-	80	-	dB
A.1.11	suppression of output signal when mute is active		-	80	-	dB
A.1.12	DC shift of the output when mute is active		-	10	50	mV
EXTERNAL AUDIO INPUT						
A.2.1	input signal amplitude (RMS value)		-	500	2000	mV
A.2.2	input resistance		-	25	-	k $\Omega$
A.2.3	voltage gain between input and output	maximum volume	-	9	-	dB
A.2.4	crosstalk between internal and external audio signals		60	-	-	dB
AUTOMATIC VOLUME LEVELLING; NOTE 28						
A.3.1	gain at maximum boost		-	6	-	dB
A.3.2	gain at minimum boost		-	-14	-	dB
A.3.3	charge (attack) current		-	1	-	mA
A.3.4	discharge (decay) current		-	200	-	nA
A.3.5	control voltage at maximum boost		-	1	-	V
A.3.6	control voltage at minimum boost		-	5	-	V

TV signal processor-Teletext decoder with  
embedded  $\mu$ -Controller

## TDA935X/6X/8X PS/N2 series

NUMBER	PARAMETER	CONDITIONS	MIN.	TYP.	MAX.	UNIT
<b>CVBS, Y/C and RGB/YUV INPUTS</b>						
CVBS-Y/C SWITCH						
S.1.1	CVBS or Y input voltage (peak-to-peak value)	note 29	–	1.0	1.4	V
S.1.2	CVBS or Y input current		–	4	–	$\mu$ A
S.1.3	suppression of non-selected CVBS input signal	notes 6 and 30	50	–	–	dB
S.1.4	chrominance input voltage (burst amplitude)	note 3 and 31	–	0.3	1.0	V
S.1.5	chrominance input impedance		–	50	–	k $\Omega$
CVBS OUTPUT ON IFVO2						
S.1.9	output signal amplitude (peak-to-peak value)		–	2.0	–	V
S.1.10	top sync level		–	1.8	–	V
S.1.11	output impedance		–	–	50	$\Omega$
EXTERNAL RGB / YUV INPUT						
S.2.1	RGB input signal amplitude for an output signal of 2 V (black-to-white) (peak-to-peak value)	note 32	–	0.7	0.8	V
S.2.2	RGB input signal amplitude before clipping occurs (peak-to-peak value)	note 6	1.0	–	–	V
S.2.3	Y input signal amplitude (peak-to-peak value)	input signal amplitude for an output signal of 2 V (black-to-white); when activated via the YUV bit; note 33	–	1.4	2.0	V
S.2.4	U input signal amplitude (peak-to-peak value)		–	–1.33	2.0	V
S.2.5	V input signal amplitude (peak-to-peak value)		–	–1.05	1.5	V
S.2.6	difference between black level of internal and external signals at the outputs		–	–	20	mV
S.2.7	input currents	no clamping; note 3	–	0.1	1	$\mu$ A
S.2.8	delay difference for the three channels	note 6	–	0	20	ns

TV signal processor-Teletext decoder with  
embedded  $\mu$ -Controller

## TDA935X/6X/8X PS/N2 series

NUMBER	PARAMETER	CONDITIONS	MIN.	TYP.	MAX.	UNIT
<b>FAST INSERTION</b>						
S.3.1	input voltage	no data insertion	–	–	0.4	V
S.3.2		data insertion	0.9	–	–	V
S.3.3	maximum input pulse	insertion	–	–	3.0	V
S.3.4	delay time from RGB in to RGB out	data insertion; note 6	–	–	20	ns
S.3.5	delay difference between insertion to RGB out and RGB in to RGB out	data insertion; note 6	–	–	20	ns
S.3.6	input current		–	–	0.2	mA
S.3.7	suppression of internal RGB signals	notes 6 and 30; insertion; $f_i = 0$ to 5 MHz	–	55	–	dB
S.3.8	suppression of external RGB signals	notes 6 and 30; no insertion; $f_i = 0$ to 5 MHz	–	55	–	dB
<b>Chrominance and Luminance filters</b>						
CHROMINANCE TRAP CIRCUIT; NOTE 34						
F.1.1	trap frequency		–	$f_{osc}$	–	MHz
F.1.2	Bandwidth at $f_{SC} = 3.58$ MHz	–3 dB	–	2.8	–	MHz
F.1.3	Bandwidth at $f_{SC} = 4.43$ MHz	–3 dB	–	3.4	–	MHz
F.1.4	colour subcarrier rejection		24	26	–	dB
F.1.5	trap frequency during SECAM reception		–	4.3	–	MHz
CHROMINANCE BANDPASS CIRCUIT						
F.2.1	centre frequency (CB = 0)		–	$f_{osc}$	–	MHz
F.2.2	centre frequency (CB = 1)		–	$1.1 \times f_{osc}$	–	MHz
F.2.3	bandpass quality factor		–	3	–	
CLOCHE FILTER						
F.3.1	centre frequency		4.26	4.29	4.31	MHz
F.3.2	Bandwidth		241	268	295	kHz
Y DELAY LINE						
F.4.1	delay time	note 6	–	480	–	ns
F.4.2	tuning range delay time	8 steps	–160	–	+160	ns
F.4.3	bandwidth of internal delay line	note 6	8	–	–	MHz

TV signal processor-Teletext decoder with  
embedded  $\mu$ -Controller

## TDA935X/6X/8X PS/N2 series

NUMBER	PARAMETER	CONDITIONS	MIN.	TYP.	MAX.	UNIT
<b>Picture Improvement Features</b>						
PEAKING CONTROL; NOTE 35						
P.1.1	width of preshoot or overshoot	note 3	–	160	–	ns
P.1.2	peaking signal compression threshold		–	50	–	IRE
P.1.3	overshoot at maximum peaking	positive	–	45	–	%
P.1.4		negative	–	80	–	%
P.1.5	Ratio negative/positive overshoot; note 36		–	1.8	–	
P.1.6	peaking control curve	63 steps	see Fig.31			
P.1.7	peaking centre frequency	setting PF1/PF0 = 0/0	–	2.7	–	MHz
P.1.8		setting PF1/PF0 = 0/1	–	3.1	–	MHz
P.1.9		setting PF1/PF0 = 1/0	–	3.5	–	MHz
BLACK LEVEL STRETCHER; NOTE 37						
P.2.1	Maximum black level shift		15	21	27	IRE
P.2.2	level shift at 100% peak white		–1	0	1	IRE
P.2.3	level shift at 50% peak white		–1	–	3	IRE
P.2.4	level shift at 15% peak white		6	8	10	IRE

TV signal processor-Teletext decoder with  
embedded  $\mu$ -Controller

## TDA935X/6X/8X PS/N2 series

NUMBER	PARAMETER	CONDITIONS	MIN.	TYP.	MAX.	UNIT
<b>Horizontal and vertical synchronization and drive circuits</b>						
SYNC VIDEO INPUT						
H.1.1	sync pulse amplitude	note 3	50	300	350	mV
H.1.2	slicing level for horizontal sync	note 38	–	50	–	%
H.1.3	slicing level for vertical sync	note 38	–	35	–	%
HORIZONTAL OSCILLATOR						
H.2.1	free running frequency		–	15625	–	Hz
H.2.2	spread on free running frequency		–	–	$\pm 2$	%
H.2.3	frequency variation with respect to the supply voltage	$V_P = 8.0 \text{ V} \pm 10\%$ ; note 6	–	0.2	0.5	%
H.2.4	frequency variation with temperature	$T_{\text{amb}} = 0 \text{ to } 70 \text{ }^\circ\text{C}$ ; note 6	–	–	80	Hz
FIRST CONTROL LOOP; NOTE 39						
H.3.1	holding range PLL		–	$\pm 0.9$	$\pm 1.2$	kHz
H.3.2	catching range PLL	note 6	$\pm 0.6$	$\pm 0.9$	–	kHz
H.3.3	signal-to-noise ratio of the video input signal at which the time constant is switched		–	24	–	dB
H.3.4	hysteresis at the switching point		–	3	–	dB
SECOND CONTROL LOOP						
H.4.1	control sensitivity		–	150	–	$\mu\text{s}/\mu\text{s}$
H.4.2	control range from start of horizontal output to flyback at nominal shift position		–	19	–	$\mu\text{s}$
H.4.3	horizontal shift range	63 steps	$\pm 2$	–	–	$\mu\text{s}$
H.4.4	control sensitivity for dynamic compensation		–	7.6	–	$\mu\text{s}/\text{V}$
H.4.5	Voltage to switch-on the 'flash' protection	note 40	6.0	–	–	V
H.4.6	Input current during protection		–	–	1	mA
H.4.7	control range of the parallelogram correction	note 41	–	$\pm 0.5$	–	$\mu\text{s}$
H.4.8	control range of the bow correction	note 41	–	$\pm 0.5$	–	$\mu\text{s}$

# TV signal processor-Teletext decoder with embedded $\mu$ -Controller

## TDA935X/6X/8X PS/N2 series

NUMBER	PARAMETER	CONDITIONS	MIN.	TYP.	MAX.	UNIT
HORIZONTAL OUTPUT; NOTE 42						
H.5.1	LOW level output voltage	$I_O = 10 \text{ mA}$	–	–	0.3	V
H.5.2	maximum allowed output current		10	–	–	mA
H.5.3	maximum allowed output voltage		–	–	$V_P$	V
H.5.4	duty factor	$V_{OUT} = \text{LOW} (T_{ON})$	–	55	–	%
H.5.5	switch-on time of horizontal drive pulse		–	1175	–	ms
H.5.6	switch-off time of horizontal drive pulse		–	43	–	ms
FLYBACK PULSE INPUT AND SANDCASTLE OUTPUT						
H.6.1	required input current during flyback pulse	note 3	100	–	300	$\mu\text{A}$
H.6.2	output voltage	during burst key	4.8	5.3	5.8	V
		during blanking	2.3	2.5	2.7	V
H.6.3	clamped input voltage during flyback		2.6	3.0	3.4	V
H.6.4	pulse width	burst key pulse	3.3	3.5	3.7	$\mu\text{s}$
H.6.5		vertical blanking, note 43	–	14/9.5	–	lines
H.6.6	delay of start of burst key to start of sync		4.6	4.8	5.0	$\mu\text{s}$
VERTICAL OSCILLATOR; NOTE 44						
H.7.1	free running frequency		–	50/60	–	Hz
H.7.2	locking range		45	–	64.5/72	Hz
H.7.3	divider value not locked		–	625/525	–	lines
H.7.4	locking range		434/488	–	722	lines/frame
VERTICAL RAMP GENERATOR						
H.8.1	sawtooth amplitude (peak-to-peak value)	$V_S = 1\text{FH};$ $C = 100 \text{ nF}; R = 39 \text{ k}\Omega$	–	3.0	–	V
H.8.2	discharge current		–	1	–	mA
H.8.3	charge current set by external resistor	note 45	–	16	–	$\mu\text{A}$
H.8.4	vertical slope	63 steps; see Fig. 46	–20	–	+20	%
H.8.5	charge current increase	$f = 60 \text{ Hz}$	–	19	–	%
H.8.6	LOW level of ramp		–	2.3	–	V
VERTICAL DRIVE OUTPUTS						
H.9.1	differential output current (peak-to-peak value)	$V_A = 1\text{FH}$	–	0.95	–	mA
H.9.2	common mode current		–	400	–	$\mu\text{A}$
H.9.3	output voltage range		0	–	4.0	V



# TV signal processor-Teletext decoder with embedded $\mu$ -Controller

## TDA935X/6X/8X PS/N2 series

NUMBER	PARAMETER	CONDITIONS	MIN.	TYP.	MAX.	UNIT
<b>EHT TRACKING/OVERVOLTAGE PROTECTION</b>						
H.10.1	input voltage		1.2	–	2.8	V
H.10.2	scan modulation range		–5	–	+5	%
H.10.3	vertical sensitivity		–	6.3	–	%/V
H.10.4	EW sensitivity	when switched-on	–	–6.3	–	%/V
H.10.5	EW equivalent output current		+100	–	–100	$\mu$ A
H.10.6	overvoltage detection level	note 40	–	3.9	–	V
<b>DE-INTERLACE</b>						
H.11.1	first field delay		–	0.5H	–	
<b>EW WIDTH; NOTE 46</b>						
H.12.1	control range	63 steps; see Fig. 49	100	–	65	%
H.12.2	equivalent output current		0	–	700	$\mu$ A
H.12.3	EW output voltage range		1.0	–	5.0	V
H.12.4	EW output current range		0	–	1200	$\mu$ A
<b>EW PARABOLA/WIDTH</b>						
H.13.1	control range	63 steps; see Fig. 50	0	–	23	%
H.13.2	equivalent output current	EW=3FH; CP=11H; TC=1FH	0	–	450	$\mu$ A
<b>EW UPPER/LOWER CORNER/PARABOLA</b>						
H.14.1	control range	63 steps; see Fig. 51	–46	–	+17	%
H.14.2	equivalent output current	PW=3FH; EW=3FH; TC=1FH	–207	–	+76	$\mu$ A
<b>EW TRAPEZIUM</b>						
H.15.1	control range	63 steps; see Fig. 52	–5	–	+5	%
H.15.2	equivalent output current	EW=1FH; CP=11H; PW=1FH	–100	–	+100	$\mu$ A
<b>VERTICAL AMPLITUDE</b>						
H.16.1	control range	63 steps; see Fig. 45	80	–	120	%
H.16.2	equivalent differential vertical drive output current (peak-to-peak value)	SC = 0EH	760	–	1140	$\mu$ A
<b>VERTICAL SHIFT</b>						
H.17.1	control range	63 steps; see Fig. 47	–5	–	+5	%
H.17.2	equivalent differential vertical drive output current (peak-to-peak value)		–50	–	+50	$\mu$ A
<b>S-CORRECTION</b>						
H.18.1	control range	63 steps; see Fig. 48	–10	–	25	%
<b>VERTICAL ZOOM MODE (OUTPUT CURRENT VARIATION WITH RESPECT TO NOMINAL SCAN); NOTE 47</b>						
H.19.1	vertical expand factor		0.75	–	1.38	
H.19.2	output current limiting and RGB blanking		–	1.05	–	

# TV signal processor-Teletext decoder with embedded $\mu$ -Controller

## TDA935X/6X/8X PS/N2 series

NUMBER	PARAMETER	CONDITIONS	MIN.	TYP.	MAX.	UNIT
<b>Colour demodulation part</b>						
CHROMINANCE AMPLIFIER						
D.1.1	ACC control range	note 48	26	–	–	dB
D.1.2	change in amplitude of the output signals over the ACC range		–	–	2	dB
D.1.3	threshold colour killer ON		–30	–	–	dB
D.1.4	hysteresis colour killer OFF	strong signal conditions; S/N $\geq$ 40 dB; note 6	–	+3	–	dB
D.1.5		noisy input signals; note 6	–	+1	–	dB
ACL CIRCUIT; NOTE 49						
D.2.1	chrominance burst ratio at which the ACL starts to operate		–	3.0	–	
REFERENCE PART						
<i>Phase-locked loop</i>						
D.3.1	catching range		$\pm 500$	–	–	Hz
D.3.2	phase shift for a $\pm 400$ Hz deviation of the oscillator frequency	note 6	–	–	2	deg
HUE CONTROL						
D.5.1	hue control range	63 steps; see Fig.32	$\pm 35$	$\pm 40$	–	deg
D.5.2	hue variation for $\pm 10\%$ $V_P$	note 6	–	0	–	deg
D.5.3	hue variation with temperature	$T_{amb} = 0$ to $70$ °C; note 6	–	0	–	deg
DEMODULATORS						
<i>General</i>						
D.6.3	spread of signal amplitude ratio between standards	note 6	–1	–	+1	dB
D.6.5	bandwidth of demodulators	–3 dB; note 50	–	650	–	kHz
<i>PAL/NTSC demodulator</i>						
D.6.6	gain between both demodulators G(B–Y) and G(R–Y)		1.60	1.78	1.96	
D.6.12	change of output signal amplitude with temperature	note 6	–	0.1	–	%/K
D.6.13	change of output signal amplitude with supply voltage	note 6	–	–	$\pm 0.1$	dB
D.6.14	phase error in the demodulated signals	note 6	–	–	$\pm 5$	deg

TV signal processor-Teletext decoder with  
embedded  $\mu$ -Controller

## TDA935X/6X/8X PS/N2 series

NUMBER	PARAMETER	CONDITIONS	MIN.	TYP.	MAX.	UNIT
<i>SECAM demodulator</i>						
D.7.1	black level off-set		–	–	7	kHz
D.7.2	pole frequency of deemphasis		77	85	93	kHz
D.7.3	ratio pole and zero frequency		–	3	–	
D.7.4	non linearity		–	–	3	%
D.7.5	calibration voltage		1.8	2.3	2.8	V
<i>Base-band delay line</i>						
D.8.1	variation of output signal for adjacent time samples at constant input signals		–0.1	–	0.1	dB
D.8.2	residual clock signal (peak-to-peak value)		–	–	5	mV
D.8.3	delay of delayed signal		63.94	64.0	64.06	$\mu$ s
D.8.4	delay of non-delayed signal		40	60	80	ns
D.8.5	difference in output amplitude with delay on or off		–	–	5	%
COLOUR DIFFERENCE MATRICES (IN CONTROL CIRCUIT)						
<i>PAL/SECAM mode; (R–Y) and (B–Y) not affected</i>						
D.9.1	ratio of demodulated signals (G–Y)/(R–Y)		–	–0.51 $\pm 10\%$	–	
D.9.2	ratio of demodulated signals (G–Y)/(B–Y)		–	–0.19 $\pm 25\%$	–	
<i>NTSC mode; the matrix results in the following signals (nominal hue setting)</i>						
MUS-bit = 0						
D.9.6	(B–Y) signal: 2.03/0°			2.03U <sub>R</sub>		
D.9.7	(R–Y) signal: 1.59/95°			–0.14U <sub>R</sub> + 1.58V <sub>R</sub>		
D.9.8	(G–Y) signal: 0.61/240°			–0.31U <sub>R</sub> – 0.53V <sub>R</sub>		
MUS-bit = 1						
D.9.9	(B–Y) signal: 2.20/–1°			2.20U <sub>R</sub> – 0.04V <sub>R</sub>		
D.9.10	(R–Y) signal: 1.53/99°			–0.24U <sub>R</sub> + 1.51V <sub>R</sub>		
D.9.11	(G–Y) signal: 0.70/223°			–0.51U <sub>R</sub> – 0.48V <sub>R</sub>		
REFERENCE SIGNAL OUTPUT/SWITCH OUTPUT; NOTE 51						
D.10.1	reference frequency	CMB1/CMB0 = 01		3.58/4.43		MHz
D.10.2	output signal amplitude (peak-to-peak value)	CMB1/CMB0 = 01	0.2	0.25	0.3	V
D.10.3	output level (mid position)	CMB1/CMB0 = 01	2.3	2.5	2.7	V
D.10.4	output level LOW	CMB1/CMB0 = 10	–	–	0.8	V
D.10.5	output level HIGH	CMB1/CMB0 = 11	4.5	–	–	V

# TV signal processor-Teletext decoder with embedded $\mu$ -Controller

## TDA935X/6X/8X PS/N2 series

NUMBER	PARAMETER	CONDITIONS	MIN.	TYP.	MAX.	UNIT
<b>Control part</b>						
SATURATION CONTROL; NOTE 32						
C.1.1	saturation control range	63 steps; see Fig.33	52	–	–	dB
CONTRAST CONTROL; NOTE 32						
C.2.1	contrast control range	63 steps; see Fig.34	–	20	–	dB
C.2.2	tracking between the three channels over a control range of 10 dB		–	–	0.5	dB
C.2.6	contrast reduction		–	10	–	dB
BRIGHTNESS CONTROL						
C.3.1	brightness control range	63 steps; see Fig.35	–	$\pm 0.7$	–	V
RGB AMPLIFIERS						
C.4.1	output signal amplitude (peak-to-peak value)	at nominal luminance input signal, nominal settings for contrast, white-point adjustment and cathode drive level (CL3-CL0 = 0111)	–	2.0	–	V
C.4.2	maximum signal amplitude (black-to-white)	note 52	–	5.5	–	V
C.4.3	maximum peak white level		–	5.5	–	V
C.4.4	output signal amplitude for the 'red' channel (peak-to-peak value)	at nominal settings for contrast and saturation control and no luminance signal to the input (R–Y, PAL)	–	2.1	–	V
C.4.5	nominal black level voltage		–	2.5	–	V
C.4.6	black level voltage	when black level stabilisation is switched-off (via AKB bit)	–	2.5	–	V
C.4.61	black level voltage control range	AVG bit active; note 53	1.8	2.5	3.2	V
C.4.7	width of video blanking with HBL bit active	note 54	13.4	13.7	14.0	$\mu$ s
C.4.8	control range of the black-current stabilisation		–	$\pm 1$	–	V
C.4.81	RGB output level when RGLB=1		–	0.8	–	V
C.4.9	blanking level	difference with black level, note 52	–	–0.5	–	V
C.4.10	level during leakage measurement		–	–0.1	–	V
C.4.11	level during 'low' measuring pulse		–	0.25	–	V
C.4.12	level during 'high' measuring pulse; note 55		–	0.5	–	V
C.4.13	adjustment range of the cathode drive level	note 52	–	$\pm 3$	–	dB

# TV signal processor-Teletext decoder with embedded $\mu$ -Controller

## TDA935X/6X/8X PS/N2 series

NUMBER	PARAMETER	CONDITIONS	MIN.	TYP.	MAX.	UNIT
C.4.131	gain control range to compensate spreads in picture tube characteristics for the 2-point black -current stabilization system; note 55		–	$\pm 6$	–	dB
C.4.14	variation of black level with temperature	note 6	–	1.0	–	mV/K
C.4.141	black level off-set adjustment on the Red and Green channel	63 steps	–	$\pm 160$	–	mV
C.4.21	signal-to-noise ratio of the output signals	RGB input; note 56	60	–	–	dB
C.4.22		CVBS input; note 56	50	–	–	dB
C.4.23	residual voltage at the RGB outputs (peak-to-peak value)	at $f_{osc}$	–	–	15	mV
C.4.24		at $2f_{osc}$ plus higher harmonics	–	–	15	mV
C.4.25	bandwidth of output signals	RGB input; at –3 dB	–	15	–	MHz
C.4.26		CVBS input; at –3 dB; $f_{osc} = 3.58$ MHz	–	2.8	–	MHz
C.4.27		CVBS input; at –3 dB; $f_{osc} = 4.43$ MHz	–	3.4	–	MHz
C.4.28		S-VHS input; at –3 dB	5	–	–	MHz
WHITE-POINT ADJUSTMENT						
C.5.1	I <sup>2</sup> C-bus setting for nominal gain	HEX code	–	20H	–	
C.5.2	adjustment range of the relative R, G and B drive levels		–	$\pm 3$	–	dB
2-POINT BLACK-CURRENT STABILIZATION, NOTES 57						
C.6.1	amplitude of 'low' reference current		–	8	–	$\mu$ A
C.6.2	amplitude of 'high' reference current; note 55		–	40	–	$\mu$ A
C.6.3	acceptable leakage current		–	$\pm 75$	–	$\mu$ A
C.6.4	maximum current during scan		–	2	–	mA
C.6.5	input impedance		–	500	–	$\Omega$
C.6.7	minimum input current to activate the guard circuit	IVG bit = "0", note 58	–	0.1	–	mA
BEAM CURRENT LIMITING						
C.7.1	contrast reduction starting voltage		–	2.8	–	V
C.7.2	voltage difference for full contrast reduction		–	1.8	–	V
C.7.3	brightness reduction starting voltage		–	1.7	–	V
C.7.4	voltage difference for full brightness reduction		–	0.9	–	V
C.7.5	internal bias voltage		–	3.3	–	V
C.7.6	detection level vertical guard	IVG bit = "1"; note 58	–	3.45	–	V

## TV signal processor-Teletext decoder with embedded $\mu$ -Controller TDA935X/6X/8X PS/N2 series

NUMBER	PARAMETER	CONDITIONS	MIN.	TYP.	MAX.	UNIT
C.7.7	minimum input current to activate the guard circuit	IVG bit = "1"; note 58	–	100	–	$\mu$ A
C.7.8	maximum allowable current		–	1	–	mA
FIXED BEAM CURRENT SWITCH-OFF; NOTE 59						
C.8.1	discharge current during switch-off		0.85	1.0	1.15	mA
C.8.2	discharge time of picture tube		–	38	–	ms

### Notes

1. When the 3.3 V supply is present and the  $\mu$ -Controller is active a 'low-power start-up' mode can be activated. When all sub-address bytes have been sent and the POR and XPR flags have been cleared the horizontal output can be switched-on via the STB-bit (subaddress 24H). In this condition the horizontal drive signal has the nominal  $T_{OFF}$  and the  $T_{ON}$  grows gradually from zero to the nominal value. As soon as the 8 V supply is present the switch-on procedure (e.g. closing of the second loop) is continued.
2. On set AGC.
3. This parameter is not tested during production and is just given as application information for the designer of the television receiver.
4. Loop bandwidth  $BL = 60$  kHz (natural frequency  $f_N = 15$  kHz; damping factor  $d = 2$ ; calculated with top sync level as FPLL input signal level).
5. The IF-PLL demodulator uses an internal VCO (no external LC-circuit required) which is calibrated by means of a digital control circuit which uses the clock frequency of the  $\mu$ -Controller as a reference. The required IF frequency for the various standards is set via the IFA-IFC bits in subaddress 27H. When the system is locked the resulting IF frequency is very accurate with a deviation from the nominal value of less than 25 kHz.
6. This parameter is not tested during production but is guaranteed by the design and qualified by means of matrix batches which are made in the pilot production period.
7. Measured at 10 mV (RMS) top sync input signal.
8. Via this pin both the demodulated IF signal and the selected CVBS (or Y+C) signal can be supplied to the output. The selection between both signals is realised by means of the SVO bit in subaddress 22H.
9. So called projected zero point, i.e. with switched demodulator.
10. Measured in accordance with the test line given in Fig.36. For the differential phase test the peak white setting is reduced to 87%.  
The differential gain is expressed as a percentage of the difference in peak amplitudes between the largest and smallest value relative to the subcarrier amplitude at blanking level.  
The phase difference is defined as the difference in degrees between the largest and smallest phase angle.
11. This figure is valid for the complete video signal amplitude (peak white-to-black), see Fig.37.
12. The noise inverter is only active in the 'strong signal mode' (no noise detected in the incoming signal)
13. The test set-up and input conditions are given in Fig.38. The figures are measured with an input signal of 10 mV RMS. This test can only be carried out in a test set-up in which the test options of the IC can be activated. This because the IF-AGC control input is not available in this IC.

## TV signal processor-Teletext decoder with embedded $\mu$ -Controller TDA935X/6X/8X PS/N2 series

14. Measured at an input signal of 10 mV<sub>RMS</sub>. The S/N is the ratio of black-to-white amplitude to the black level noise voltage (RMS value). B = 5 MHz. Weighted in accordance with CCIR 567.
15. The time-constant of the IF-AGC is internal and the speed of the AGC can be set via the bits AGC1 and AGC0 in subaddress 28H. The AGC response time is also dependent on the acquisition time of the PLL demodulator. The values given are valid for the 'norm' setting (AGC1-AGC0 = 0-1) and when the PLL is in lock.
16. The AFC control voltage is generated by the digital tuning system of the PLL demodulator. This system uses the clock frequency of the  $\mu$ -Controller/Teletext decoder as a reference and is therefore very accurate. For this reason no maximum and minimum values are given for the window sensitivity figures (parameters M.7.2 and M.7.3). The tuning information is supplied to the tuning system via the AFA and AFB bits in output byte 02H. The AFC value is valid only when the LOCK-bit is 1.
17. The weighted S/N ratio is measured under the following conditions:
- The vision IF modulator must meet the following specifications:  
Incidental phase modulation for black-to-white jumps less than 0.5 degrees.  
QSS AF performance, measured with the television-demodulator AMF2 (audio output, weighted S/N ratio) better than 60 dB (deviation 27 kHz) for 6 kHz sine wave black-to-white modulation.  
Picture-to-sound carrier ratio: PC/SC1 = 13 dB (transmitter).
  - The measurements must be carried out with the Siemens SAW filters G3962 for vision IF and G9350 for sound IF. Input level for sound IF 10 mV<sub>RMS</sub> with 27 kHz deviation.
  - The PC/SC ratio at the vision IF input is calculated as the addition of the TV transmitter ratio and the SAW filter PC/SC ratio. This PC/SC ratio is necessary to achieve the S/N(W) values as indicated.
18. Calculation of the FM-PLL filter can be done approximately by use of the following equations:

$$f_0 = \frac{1}{2\pi\sqrt{C_P}} \sqrt{K_0 K_D}$$

$$\nu = \frac{1}{2R\sqrt{K_0 K_D C_P}}$$

$$BL_{-3dB} = f_0(1.55 - \nu^2)$$

These equations are only valid under the conditions that  $\nu \leq 1$  and  $C_S > 5C_P$ .

Definitions:

$K_0$  = VCO steepness in rad/V

$K_D$  = phase detector steepness  $\mu$ A/rad

R = loop filter resistor

$C_S$  = series capacitor

$C_P$  = parallel capacitor

$f_0$  = natural frequency of PLL

$BL_{-3dB}$  = loop bandwidth for -3dB

$\nu$  = damping factor

Some examples for these values are given in table 132

19. Modulation frequency: 1 kHz,  $\Delta f = \pm 50$  kHz.
20. f = 4.5/5.5 MHz; FM: 70 Hz,  $\pm 50$  kHz deviation; AM: 1.0 kHz, 30% modulation.
21. This figure is independent of the TV standard and valid for a frequency deviation of  $\pm 25$  kHz at a carrier frequency of 4.5 MHz or a deviation of  $\pm 50$  kHz at a carrier frequency of 5.5/6.0/6.5 MHz.

## TV signal processor-Teletext decoder with embedded $\mu$ -Controller

## TDA935X/6X/8X PS/N2 series

22. The deemphasis pin can also be used as additional audio input. In that case the internal (demodulated FM signal) must be switched off. This can be realised by means of the SM (sound mute) bit. When the vision IF amplifier is switched to positive modulation the signal from the FM demodulator is automatically switched off. The external signal must be switched off when the internal signal is selected.
23. The signal-to-noise ratio is measured under the following conditions:
  - a) Input signal to the SNDIF pin (activated via SIF bit) with an amplitude of  $100\text{mV}_{\text{RMS}}$ ,  $f_{\text{MOD}} = 1\text{ kHz}$  and  $\Delta f = 27\text{ kHz}$
  - b) Output signal measured at the AUDEEM pin. The noise (RMS value) is measured according to the CCIR 468 definition.
24. Audio input signal  $200\text{ mV}_{\text{RMS}}$ . Measured with a bandwidth of  $15\text{ kHz}$  and the audio attenuator at  $-6\text{ dB}$ .
25. Audio input signal  $1\text{ V}_{\text{RMS}}$  and the volume control setting such that no clipping occurs in the audio output.
26. Unweighted RMS value, audio input signal  $500\text{ mV}_{\text{RMS}}$ , audio attenuator at  $-6\text{ dB}$ .
27. Audio attenuator at  $-20\text{ dB}$ ; temperature range  $10\text{ to }50\text{ }^{\circ}\text{C}$ .
28. In various versions the Automatic Volume Levelling (AVL) function can be activated. The pin to which the external capacitor has to be connected depends on the IC version. For the  $90^{\circ}$  types the capacitor is connected to the EW output pin. For the  $110^{\circ}$  types a choice can be made between the AVL function and a sub-carrier output / general purpose switch output. The selection must be made by means of the CMB0 and CMB1 bit in subaddress 22H. More details about the sub-carrier output are given in the parameters D.10.  
 The Automatic Volume Levelling (AVL) circuit stabilises automatically the audio output signal to a certain level which can be set by means of the volume control. This AVL function prevents big audio output fluctuations due to variation of the modulation depth of the transmitter. The AVL can be switched on and off via the AVL bit in subaddress 29H. The AVL is active over an input voltage range (measured at the deemphasis output) of  $150\text{ to }1500\text{ mV}_{\text{RMS}}$ . The AVL control curve is given in Fig.39. The control range of  $+6\text{ dB to }-14\text{ dB}$  is valid for input signals with 50% of the maximum frequency deviation.
29. Signal with negative-going sync. Amplitude includes sync pulse amplitude.
30. This parameter is measured at nominal settings of the various controls.
31. Indicated is a signal for a colour bar with 75% saturation (chroma : burst ratio = 2.2 : 1).
32. The contrast and saturation control is active on the internal signal (YUV) and on the external RGB/YUV input. The Text/OSD input can be controlled on brightness only. Nominal contrast is specified with the DAC in position 20 HEX. Nominal saturation as maximum  $-10\text{ dB}$ .
33. The YUV input signal amplitudes are based on a colour bar signal with 75/100% saturation.
34. When the decoder is forced to a fixed subcarrier frequency (via the CM-bits) the chroma trap is always switched-on, also when no colour signal is identified. In the automatic mode the chroma trap is switched-off when no colour signal is identified.
35. Valid for a signal amplitude on the Y-input of  $0.7\text{ V}$  black-to-white (100 IRE) with a rise time (10% to 90%) of  $70\text{ ns}$  and the video switch in the Y/C mode. During production the peaking function is not tested by measuring the overshoots but by measuring the frequency response of the Y output.
36. The ratio between the positive and negative peaks can be varied by means of the bits RPO1 and RPO0 in subaddress 2EH. For ratios which are smaller than 1.8 the positive peak is not affected and the negative peak is reduced.
37. For video signals with a black level which deviates from the back-porch blanking level the signal is "stretched" to the blanking level. The amount of correction depends on the IRE value of the signal (see Fig.40). The black level is detected by means of an internal capacitor. The black level stretcher can be switched on and off via the BKS bit in subaddress 2DH. The values given in the specification are valid only when the luminance input signal has an amplitude of  $1\text{ V}_{\text{p-p}}$ .



## TV signal processor-Teletext decoder with embedded $\mu$ -Controller TDA935X/6X/8X PS/N2 series

38. The slicing level is independent of sync pulse amplitude. The given percentage is the distance between the slicing level and the black level (back porch). When the amplitude of the sync pulse exceeds the value of 350 mV the sync separator will slice the sync pulse at a level of 175 mV above top sync. The maximum sync pulse amplitude is  $4 V_{p-p}$ .

The vertical slicing level is dependent on the S/N ratio of the incoming video signal. For a  $S/N \leq 24$  dB the slicing level is 35%, for a  $S/N \geq 24$  dB the slicing level is 60%. With the bit FSL (Forced Slicing Level) the vertical slicing level can be forced to 60%.

39. To obtain a good performance for both weak signal and VCR playback the time constant of the first control loop is switched depending on the input signal condition and the condition of the POC, FOA, FOB and VID bits in subaddress 24H. The circuit contains a noise detector and the time constant is switched to 'slow' when too much noise is present in the signal. In the 'fast' mode during the vertical retrace time the phase detector current is increased 50% so that phase errors due to head-switching of the VCR are corrected as soon as possible. Switching of the time constant can be automatically or can be set by means of the control bits.

The circuit contains a video identification circuit which is independent of the first loop. This identification circuit can be used to close or open the first control loop when a video signal is present or not present on the input. This enables a stable On Screen Display (OSD) when just noise is present at the input.

To prevent that the horizontal synchronisation is disturbed by anti copy signals like Macrovision the phase detector is gated during the vertical retrace period so that pulses during scan have no effect on the output voltage. The width of the gate pulse is about 22  $\mu$ s. During weak signal conditions (noise detector active) the gating is active during the complete scan period and the width of the gate pulse is reduced to 5.7  $\mu$ s so that the effect of noise is reduced to a minimum.

The output current of the phase detector in the various conditions are shown in Table 133.

40. The ICs have 2 protection inputs. The protection on the second phase detector pin is intended to be used as 'flash' protection. When this protection is activated the horizontal drive is switched-off immediately and then switched-on again via the slow start procedure.

The protection on the EHT input is intended for overvoltage (X-ray) protection. When this protection is activated the horizontal drive is directly switched-off (via the slow stop procedure).

The EHT protection input can also be used to switch-off the TV receiver in a correct way when it is switched off via the mains power switch or when the power supply is interrupted by pulling the mains plug. This can be realised by means of a detection circuit which monitors the main supply voltage of the receiver. When this voltage suddenly decreases the EHT protection input must be pulled HIGH and then the horizontal drive is switched off via the slow stop procedure. Whether the EHT capacitor is discharged in the overscan or not during the switch-off period depends on the setting of the OSO bit (subaddress 25H, D4). See also note 59.

41. The control range indicates the maximum phase difference at the top and the bottom of the screen. Compared with the phase position at the centre of the screen the maximum phase difference at the top and the bottom of the screen is  $\pm 0.5 \mu$ s for both the parallelogram and the bow correction.

42. During switch-on the horizontal drive starts-up in a soft-start mode. The horizontal drive starts with a very short  $T_{ON}$  time of the horizontal output transistor, the 'off time' of the transistor is identical to the 'off time' in normal operation. The starting frequency during switch-on is therefore about 2 times higher than the normal value. The 'on time' is slowly increased to the nominal value in a time of about 1175 ms (see Fig.42). The rather slow rise of the  $T_{ON}$  between 75% and 100% of  $T_{ON}$  is introduced to obtain a sufficiently slow rise of the EHT for picture tubes with Dynamic Astigmatic Focus (DAF) guns. When the nominal frequency is reached the PLL is closed in such a way that only very small phase corrections are necessary. This ensures a safe operation of the output stage.

During switch-off the soft-stop function is active. This is realised by decreasing the  $T_{ON}$  of the output transistor complimentary to the start-up behaviour. The switch-off time is about 43 ms (see Fig.42). When the 'switch off command' is received the soft-stop procedure is started after a delay of about 2 ms. During the switch-off time the EHT capacitor of the picture tube is discharged with a fixed beam current which is forced by the black current loop (see also note 59). The discharge time is about 38 ms.

The horizontal output is gated with the flyback pulse so that the horizontal output transistor cannot be switched-on during the flyback time.

## TV signal processor-Teletext decoder with embedded $\mu$ -Controller

## TDA935X/6X/8X PS/N2 series

43. The vertical blanking pulse in the RGB outputs has a width of 27 or 22 lines (50 or 60 Hz system). The vertical pulse in the sandcastle pulse has a width of 14 or 9.5 lines (50 or 60 Hz system). This to prevent a phase distortion on top of the picture due to a timing modulation of the incoming flyback pulse.
44. The timing pulses for the vertical ramp generator are obtained from the horizontal oscillator via a divider circuit. During TV reception this divider circuit has 3 modes of operation:
- Search mode 'large window'.  
This mode is switched on when the circuit is not synchronized or when a non-standard signal (number of lines per frame outside the range between 311 and 314(50 Hz mode) or between 261 and 264 (60 Hz mode) is received). In the search mode the divider can be triggered between line 244 and line 361 (approximately 45 to 64.5 Hz).
  - Standard mode 'narrow window'.  
This mode is switched on when more than 15 succeeding vertical sync pulses are detected in the narrow window. When the circuit is in the standard mode and a vertical sync pulse is missing the retrace of the vertical ramp generator is started at the end of the window. Consequently, the disturbance of the picture is very small. The circuit will switch back to the search window when, for 6 successive vertical periods, no sync pulses are found within the window.
  - Standard TV-norm (divider ratio 525 (60 Hz) or 625 (50 Hz)).  
When the system is switched to the narrow window it is checked whether the incoming vertical sync pulses are in accordance with the TV-norm. When 15 standard TV-norm pulses are counted the divider system is switched to the standard divider ratio mode. In this mode the divider is always reset at the standard value even if the vertical sync pulse is missing.  
When 3 vertical sync pulses are missed the system switches back to the narrow window and when also in this window no sync pulses are found (condition 3 missing pulses) the system switches over to the search window.  
The vertical divider needs some waiting time during channel-switching of the tuner. When a fast reaction of the divider is required during channel-switching the system can be forced to the search window by means of the NCIN bit in subaddress 25H.  
When RGB signals are inserted the maximum vertical frequency is increased to 72 Hz. This has the consequence that the circuit can also be synchronised by signals with a higher vertical frequency like VGA.
45. Conditions: frequency is 50 Hz; normal mode; VS = 1F.
46. The output range percentages mentioned for E-W control parameters are based on the assumption that 400  $\mu$ A variation in E-W output current is equivalent to 20% variation in picture width.
47. The ICs have a zoom adjustment possibility for the horizontal and vertical deflection. For this reason an extra DAC has been added in the vertical amplitude control which controls the vertical scan amplitude between 0.75 and 1.38 of the nominal scan. At an amplitude of 1.06 of the nominal scan the output current is limited and the blanking of the RGB outputs is activated. This is illustrated in Fig. 41.
- The nominal scan height must be adjusted at a position of 19 HEX of the vertical 'zoom' DAC.
48. At a chrominance input voltage of 660 mV (p-p) (colour bar with 75% saturation i.e. burst signal amplitude 300 mV (p-p)) the dynamic range of the ACC is +6 and -20 dB.
49. The ACL function can be activated by via the ACL bit in the subaddress 20H. The ACL circuit reduces the gain of the chroma amplifier for input signals with a chroma-to-burst ratio which exceeds a value of 3.0.
50. This parameter indicates the bandwidth of the complete chrominance circuit including the chrominance bandpass filter. The bandwidth of the low-pass filter of the demodulator is approximately 1 MHz.
51. The subcarrier output is combined with a 3-level switch output which can be used to switch external circuits like sound traps etc. This output is controlled by the CMB1 and CMB0 bits in control byte 22H. The subcarrier signal is available when CMB1/0 are set to 0/1. During the demodulation of SECAM signals the subcarrier signal is only available during the vertical retrace period. The frequency is 4.43 MHz in this condition. When CMB1/0 are set to 00 in versions for 90° picture tubes (no EW output) the output is high ohmic.

## TV signal processor-Teletext decoder with embedded $\mu$ -Controller

## TDA935X/6X/8X PS/N2 series

52. Because of the 2-point black current stabilization circuit both the black level and the amplitude of the RGB output signals depend on the drive characteristic of the picture tube. The system checks whether the returning measuring currents meet the requirement and adapts the output level and gain of the circuit when necessary. Therefore the typical value of the black level and amplitude at the output are just given as an indication for the design of the RGB output stage.

The 2-point black level system adapts the drive voltage for each cathode in such a way that the 2 measuring currents have the right value. This has the consequence that a change in the gain of the output stage will be compensated by a gain change of the RGB control circuit. Because different picture tubes may require different drive voltage amplitudes the ratio between the output signal amplitude and the inserted measuring pulses can be adapted via the I<sup>2</sup>C-bus. This is indicated in the parameter 'Adjustment range of the cathode drive level'.

Because of the dependence of the output signal amplitude on the application the soft clipping limiting has been related to the input signal amplitude.

53. The alignment system for the  $V_{g2}$  voltage of the picture tube can be activated by means of the AVG bit. In that condition a certain black level is inserted at the RGB outputs during a few lines. The value of this level can be adjusted by means of the brightness control DAC. An automatic adjustment of the  $V_{g2}$  of the picture tube can be realised by using the WBC and HBC bits in output byte 01. For a black level feedback current between 12 and 20  $\mu$ A the WBC = 1, for a higher or lower current WBC = 0. Whether the current is too high or too low can be found from the HBC bit. The indication of these bits can be made visible on the screen via OSD so that this alignment procedure can also be used for service purposes.
54. When the reproduction of 4 : 3 pictures on a 16 : 9 picture tube is realised by means of a reduction of the horizontal scan amplitude the edges of the picture may slightly be disturbed. This effect can be prevented by adding an additional blanking to the RGB signals. The blanking pulse is derived from the horizontal oscillator and is directly related to the incoming video signal (independent of the flyback pulse). This blanking is activated with the HBL bit.
55. This parameter is valid only when the CCC loop is active.
56. Signal-to-noise ratio (S/N) is specified as peak-to-peak signal with respect to RMS noise (bandwidth 5 MHz).
57. This is a current input. The timing of the measuring pulses and the vertical blanking for the 50/60 Hz standard are given in Fig.43

The start-up procedure is as follows.

When the TV receiver is switched-on the RGB outputs are blanked and the black-current loop will try to adjust the picture tube to the right bias levels. The RGB drive signals are switched-on as soon as the black current loop is stabilised. This results in the shortest switch-on time.

When this switch-on system results in a visible disturbance of the picture it is possible to add a further switch-on delay via a software routine. In that case the RGB outputs must be blanked by means of the RBL bit. As soon as the black current loop is stabilised the BCF-bit is set to 0 (output byte 01). This information can then be used to switch-on the RGB outputs with some additional delay.

58. The input of the vertical guard function can be connected to the black current measuring input (BLKIN) or to the beam current limiting input (BCLIN). The switching between these modes is realised by means of the IVG bit in subaddress 2BH. When the black current input is chosen it should be noted that for a reliable operation of the protection system and the black current stabilization system the end of the protection pulse during normal operation should not overlap the measuring pulses (see also Fig.43). Therefore this pulse must end before line 14.

## TV signal processor-Teletext decoder with embedded $\mu$ -Controller TDA935X/6X/8X PS/N2 series

59. During switch-off the magnitude of the discharge current of the picture tube is controlled by the black current loop. Dependent on the setting of the OSO bit the vertical scan can be stopped in an overscan position during that time so that the discharge is not visible on the screen. The switch-off procedure is as follows:
- When the switch-off command is received the RGB outputs are blanked for a time of about 2 ms.
  - If OSO = 1 the vertical scan is placed in an overscan position
  - If OSO = 0 the vertical deflection will keep running during the switch-off time
  - The soft-stop procedure is started with a reduction of the  $T_{ON}$  of the output stage from nominal to zero
  - The fixed beam current is forced via the black current loop
  - The soft-stop time has a value of 43 ms, the fixed beam current is flowing during a time of 38 ms.

**Table 132** Some examples for the FM-PLL filter

BL <sub>-3dB</sub> (kHz)	C <sub>S</sub> (nF)	C <sub>P</sub> (nF)	R (k $\Omega$ )	v
100	4.7	820	2.7	0.5
160	4.7	330	3.9	0.5

**Table 133** Output current of the phase detector in the various conditions

I <sup>2</sup> C-BUS COMMANDS				IC CONDITIONS			$\phi$ -1 CURRENT/MODE			
VID	POC	FOA	FOB	IFI	SL	NOISE	SCAN	V-RETR	GATING	MODE
–	0	0	0	yes	yes	no	200	300	yes <sup>(1)</sup>	normal
–	0	0	0	yes	yes	yes	30	30	yes <sup>(2)</sup>	normal
–	0	0	0	yes	no	–	200	300	no	normal
–	0	0	1	yes	yes	–	30	30	yes <sup>(2)</sup>	slow
–	0	0	1	yes	no	–	200	300	no	slow
–	0	1	0	yes	yes	no	200	300	yes <sup>(2)</sup>	slow/fast
–	0	1	0	yes	yes	yes	30	30	yes <sup>(2)</sup>	slow/fast
–	–	1	1	–	–	–	200	300	yes <sup>(1)</sup>	fast
0	0	–	–	no	–	–	6	6	no	OSD
–	1	–	–	–	–	–	–	–	–	off

### Note

- Gating is active during vertical retrace, the width is 22  $\mu$ s. This gating prevents disturbance due to Macro Vision Anti Copy signals.
- Gating is continuously active and is 5.7  $\mu$ s wide

TV signal processor-Teletext decoder with embedded  $\mu$ -Controller

TDA935X/6X/8X PS/N2 series

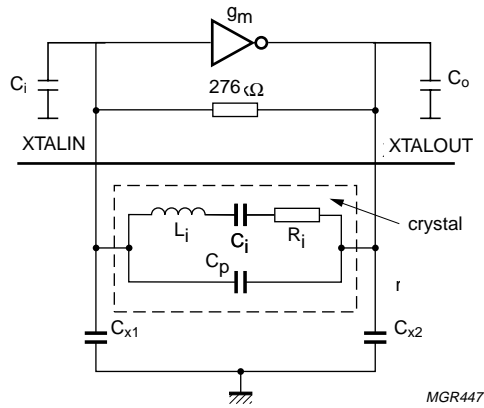

$$f_{osc} = \frac{1}{2\pi \sqrt{L_i \times \frac{C_i \times C_{tot}}{C_i + C_{tot}}}}$$

$$C_{tot} = C_p + \frac{C_a \times C_b}{C_a + C_b}$$

$$C_a = C_i + C_{x1}$$

$$C_b = C_o + C_{x2}$$

MGR447

Fig.29 Simplified diagram crystal oscillator.

TV signal processor-Teletext decoder with embedded  $\mu$ -Controller

TDA935X/6X/8X PS/N2 series

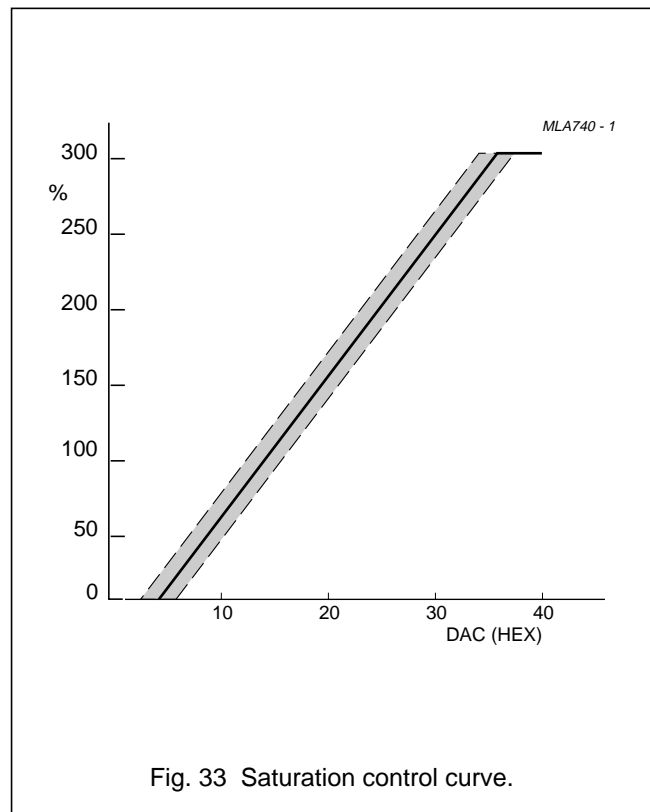
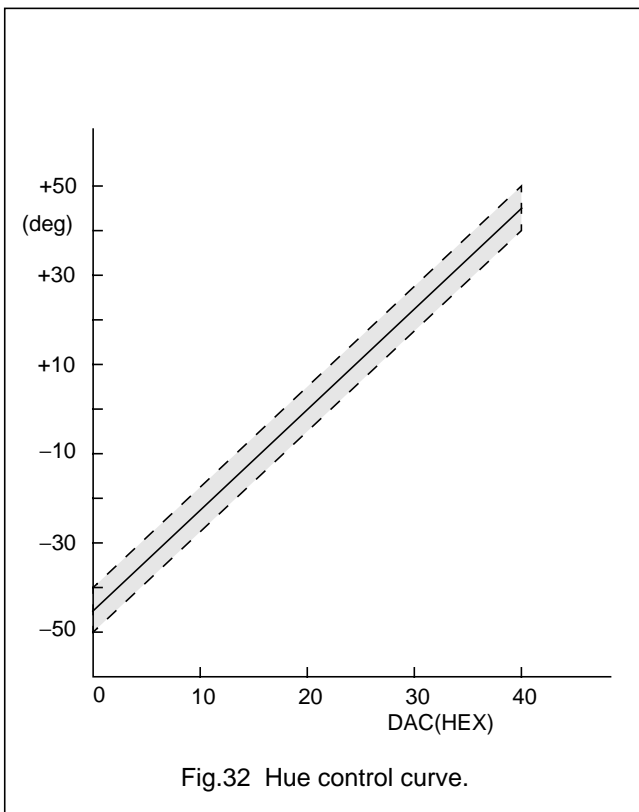
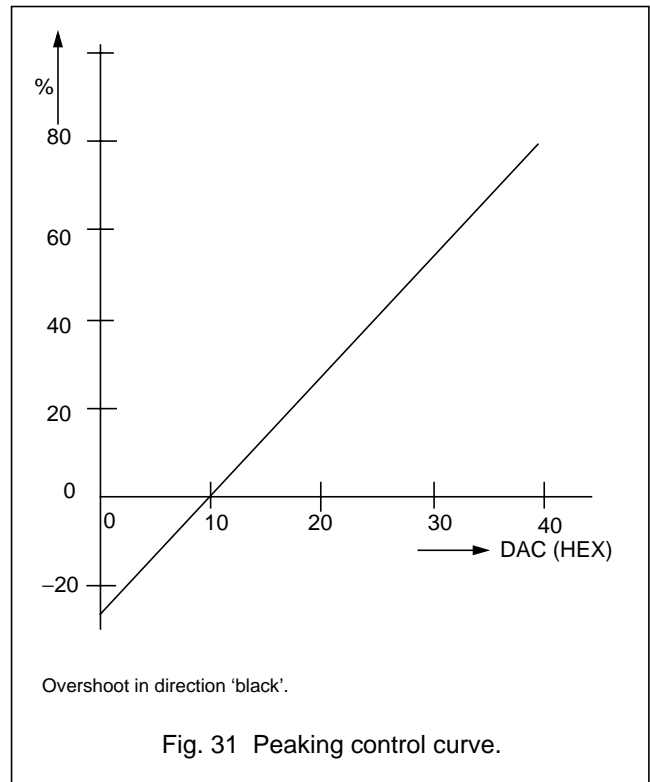
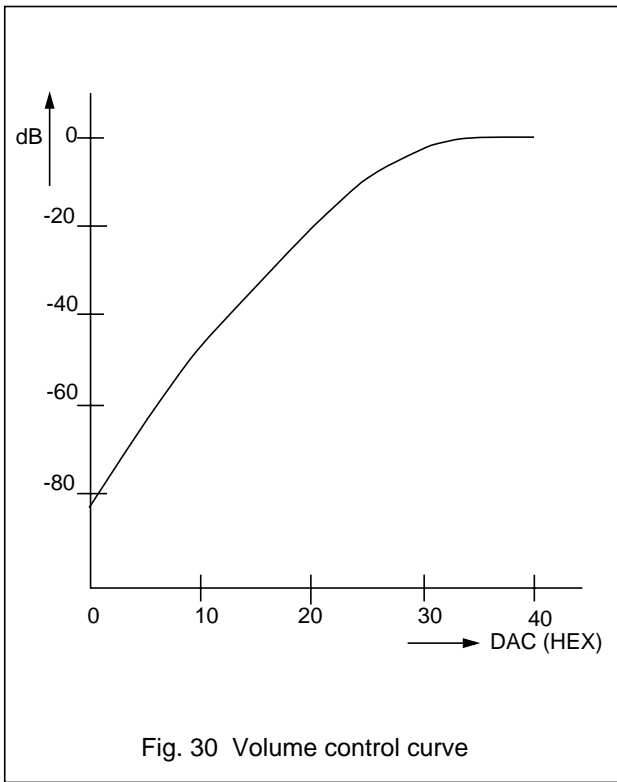

TV signal processor-Teletext decoder with embedded  $\mu$ -Controller

TDA935X/6X/8X PS/N2 series

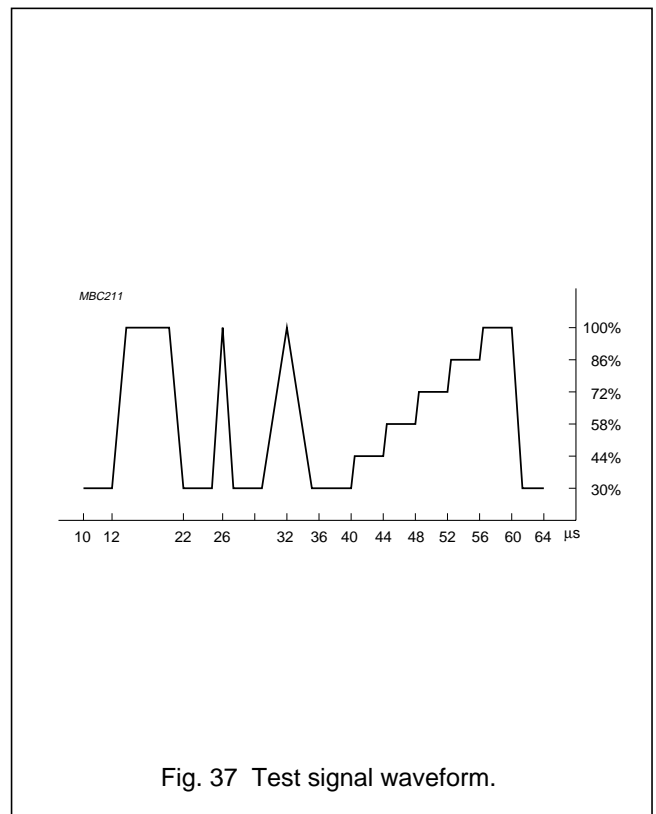
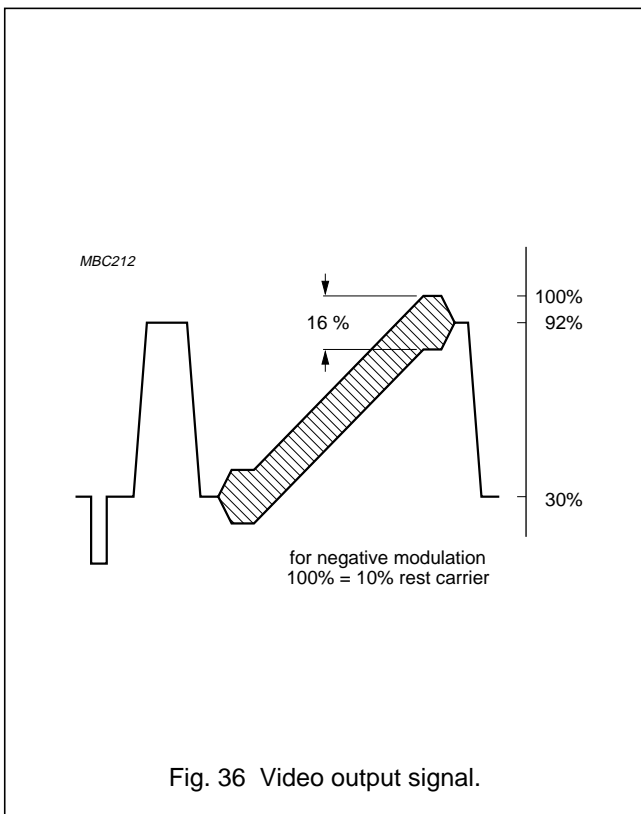
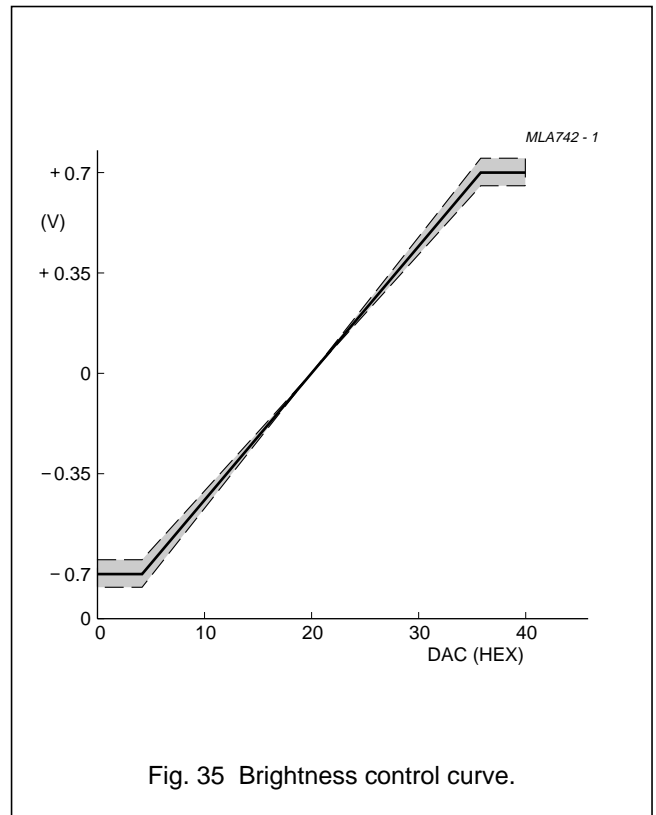
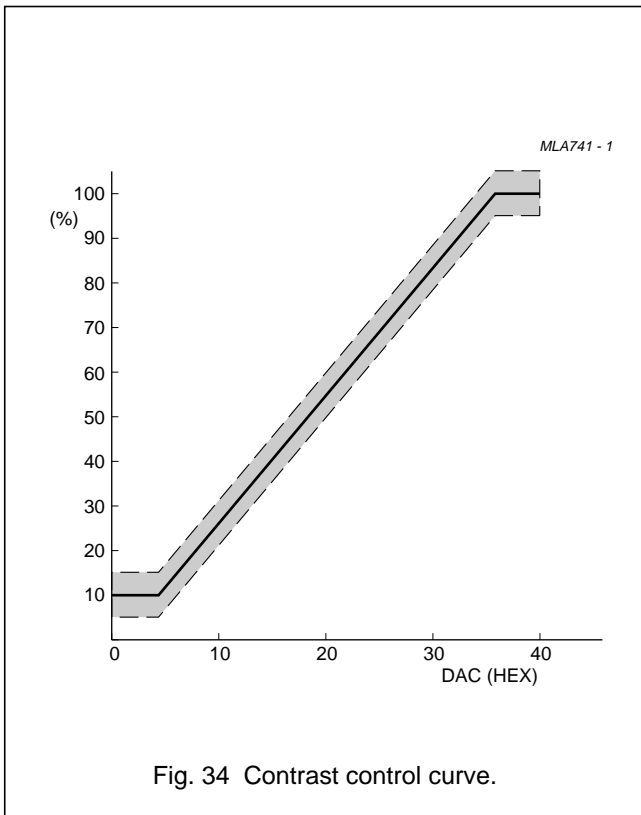

TV signal processor-Teletext decoder with embedded  $\mu$ -Controller

TDA935X/6X/8X PS/N2 series

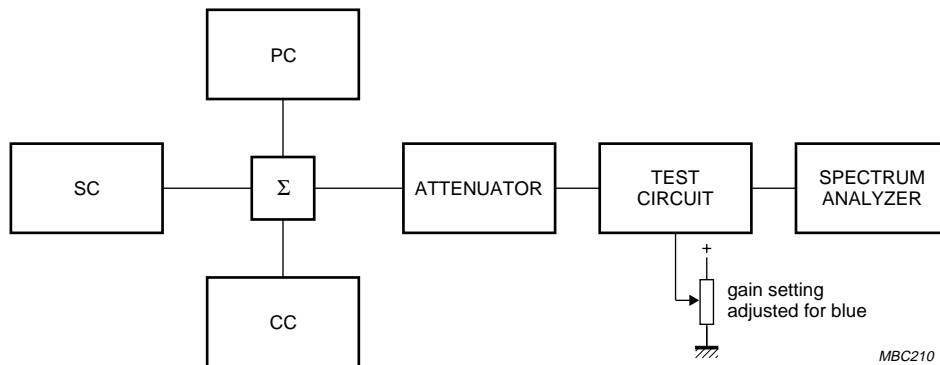
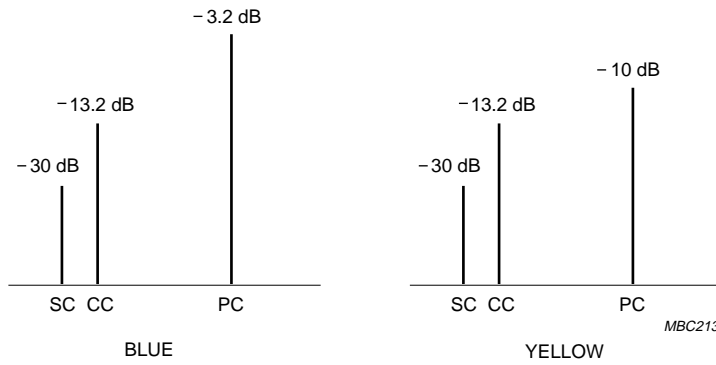

Input signal conditions: SC = sound carrier; CC = colour carrier; PC = picture carrier.  
All amplitudes with respect to top sync level.

$$\text{Value at 0.92 or 1.1 MHz} = 20 \log \frac{V_O \text{ at 3.58 or 4.4 MHz}}{V_O \text{ at 0.92 or 1.1 MHz}} + 3.6 \text{ dB}$$

$$\text{Value at 2.66 or 3.3 MHz} = 20 \log \frac{V_O \text{ at 3.58 or 4.4 MHz}}{V_O \text{ at 2.66 or 3.3 MHz}}$$

Fig. 38 Test set-up intermodulation.



TV signal processor-Teletext decoder with embedded  $\mu$ -Controller

TDA935X/6X/8X PS/N2 series

CHARACTERISTIC POINTS AVL	A	B	C	D	UNIT
Deemphasis voltage	150	300	500	1500	mV <sub>RMS</sub>
FM swing	15	30	50	150	kHz

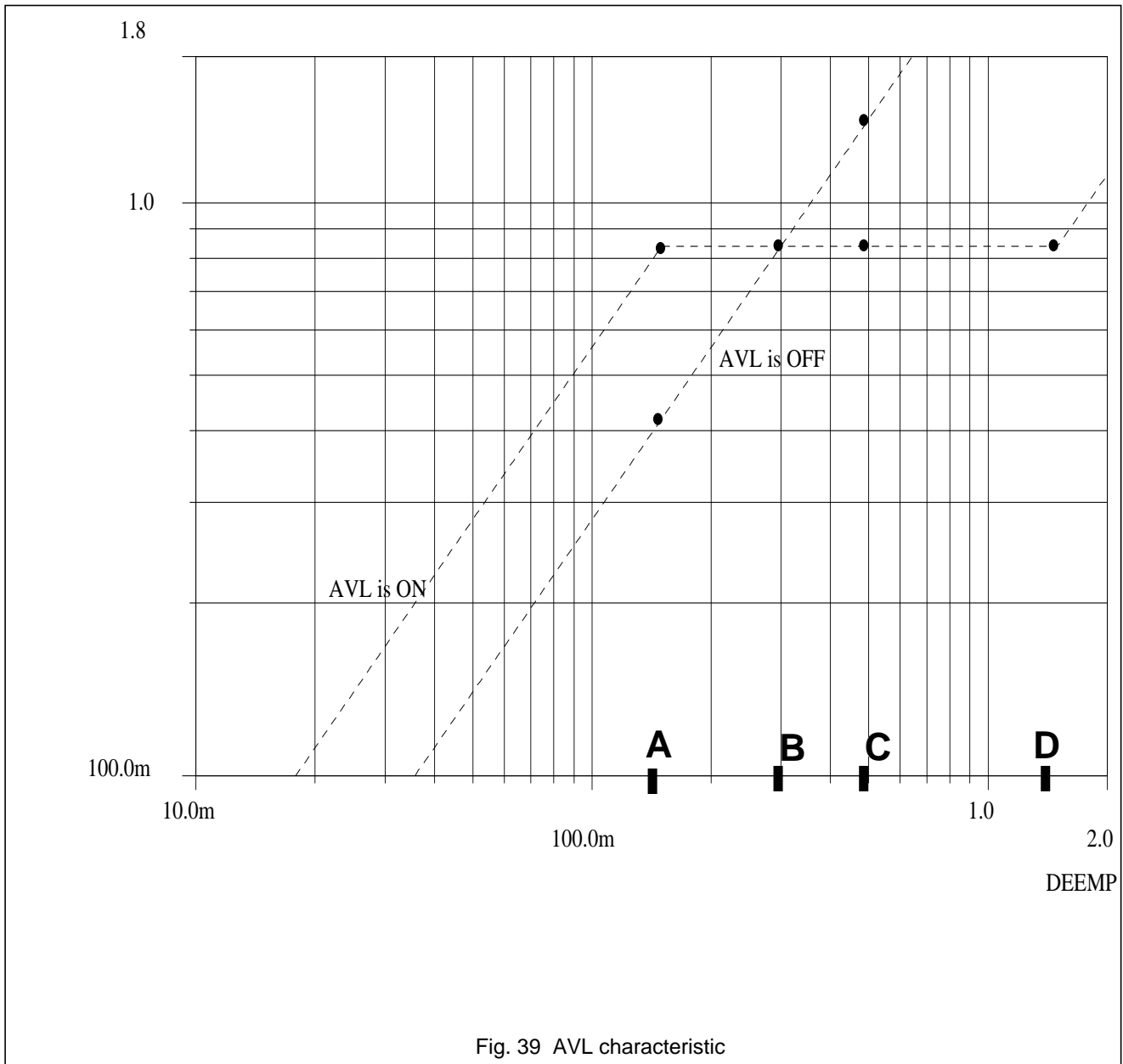

TV signal processor-Teletext decoder with embedded  $\mu$ -Controller

TDA935X/6X/8X PS/N2 series

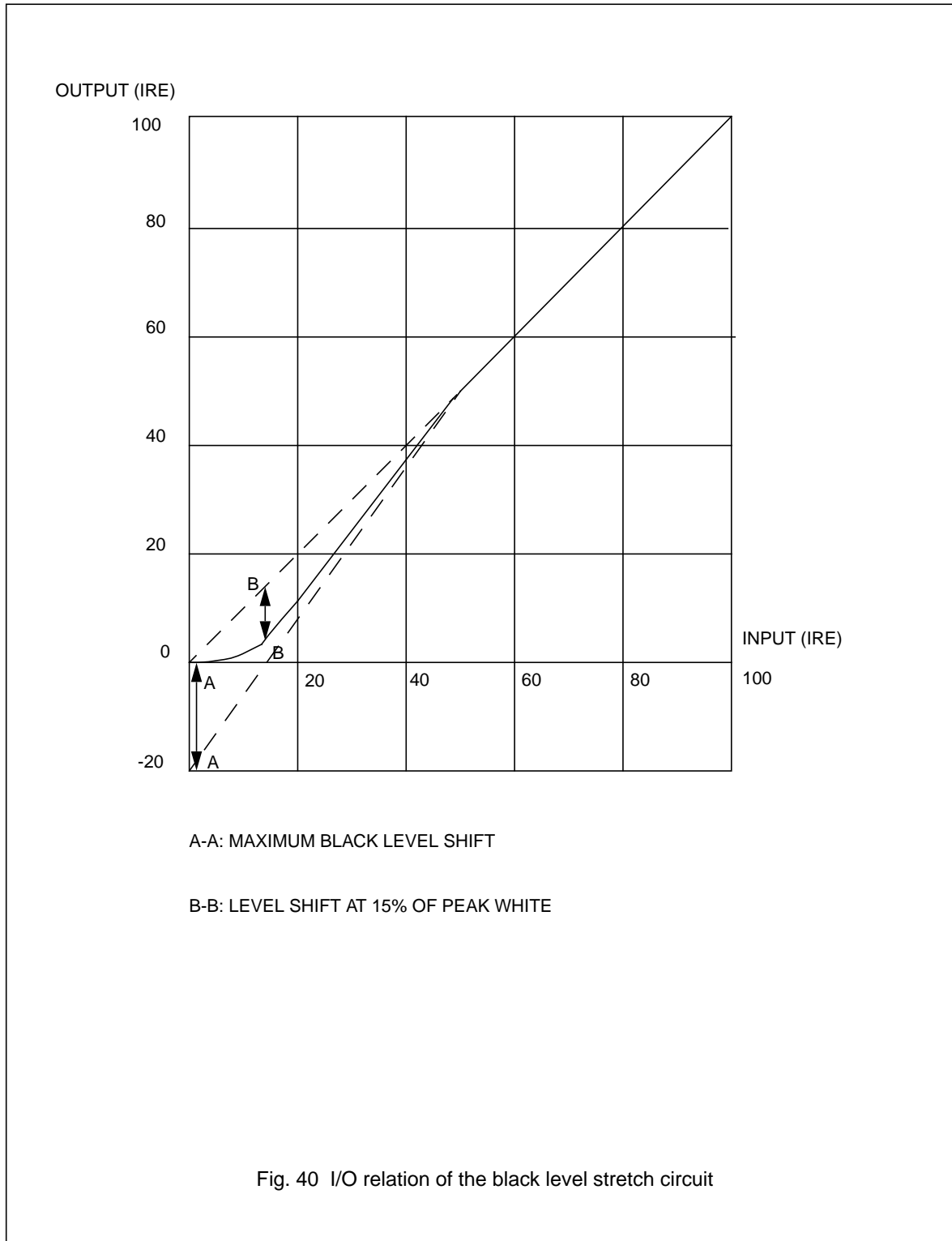

TV signal processor-Teletext decoder with embedded  $\mu$ -Controller

TDA935X/6X/8X PS/N2 series

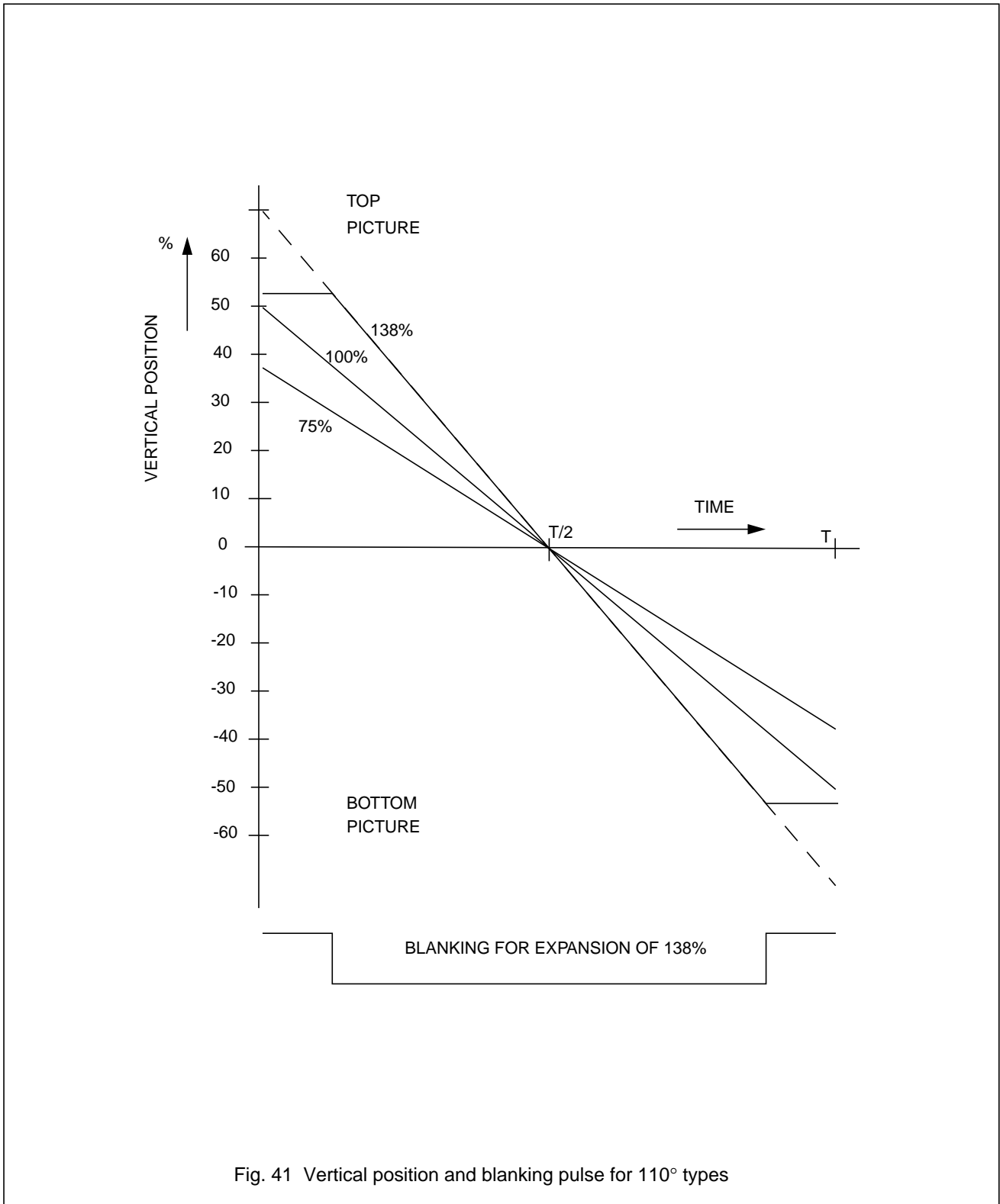

Fig. 41 Vertical position and blanking pulse for 110° types

TV signal processor-Teletext decoder with  
embedded  $\mu$ -Controller

TDA935X/6X/8X PS/N2 series

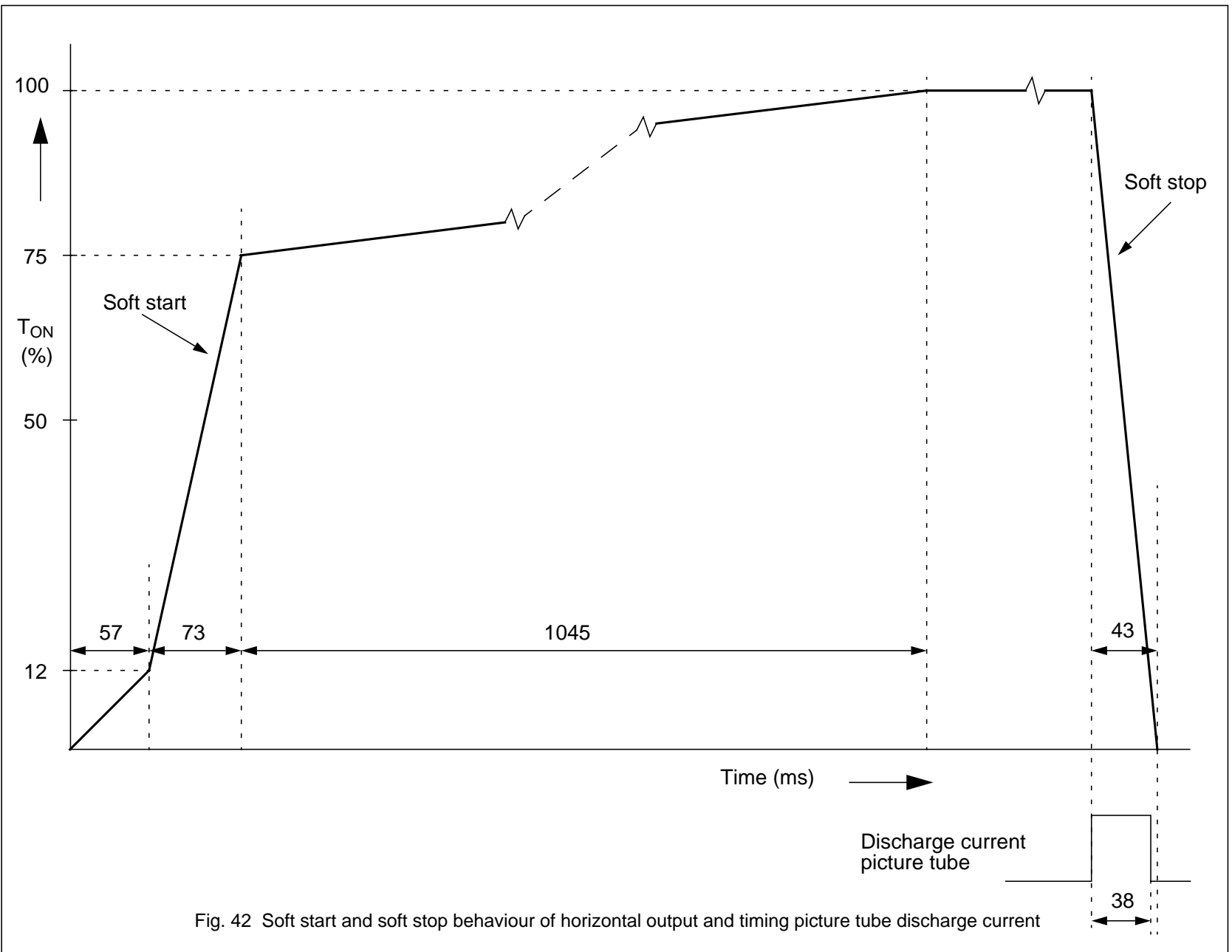

Fig. 42 Soft start and soft stop behaviour of horizontal output and timing picture tube discharge current

TV signal processor-Teletext decoder with embedded  $\mu$ -Controller

TDA935X/6X/8X PS/N2 series

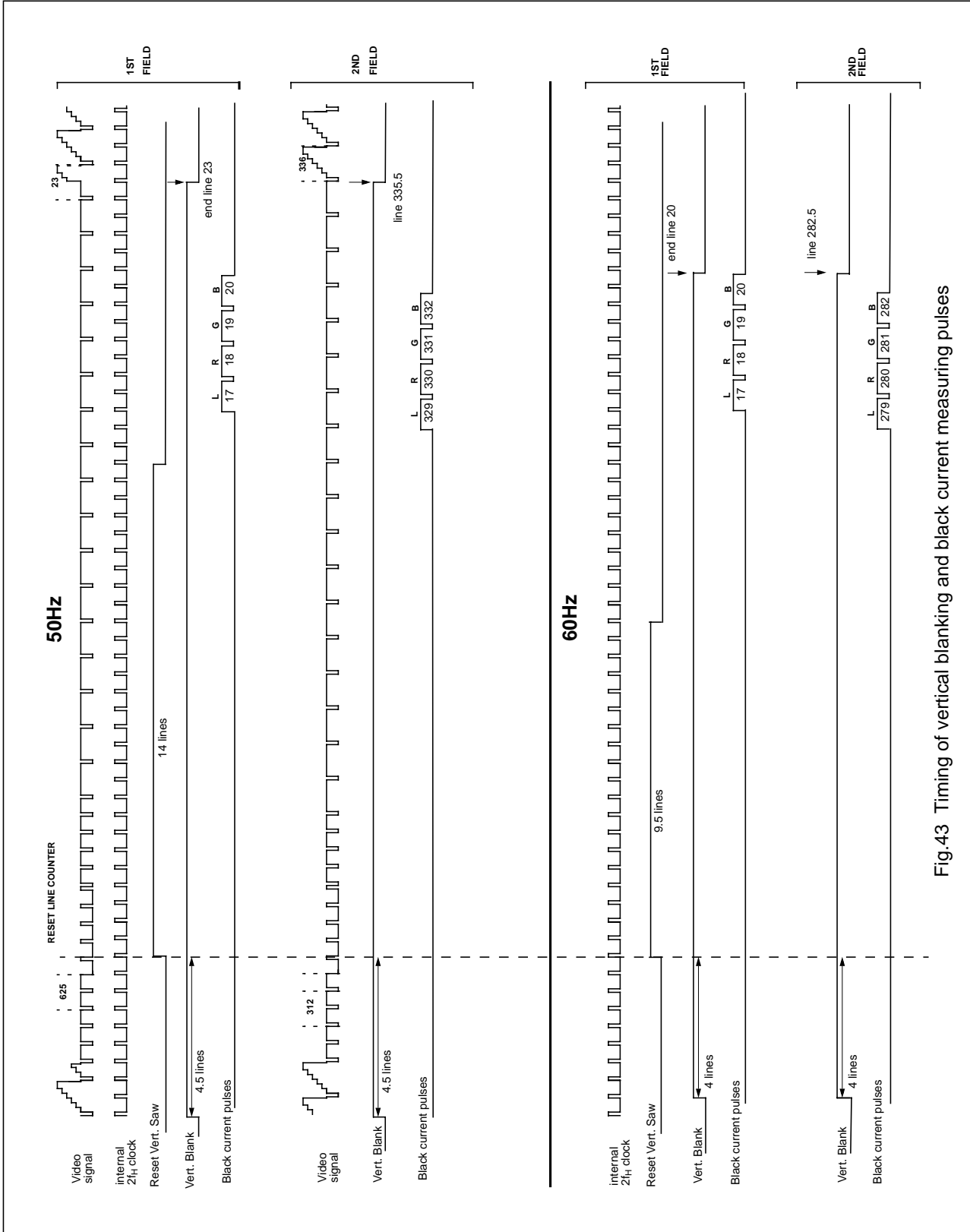

Fig.43 Timing of vertical blanking and black current measuring pulses

TV signal processor-Teletext decoder with embedded  $\mu$ -Controller

TDA935X/6X/8X PS/N2 series

TEST AND APPLICATION INFORMATION

East-West output stage

In order to obtain correct tracking of the vertical and horizontal EHT-correction, the EW output stage should be dimensioned as illustrated in Fig.44.

Resistor  $R_{EW}$  determines the gain of the EW output stage. Resistor  $R_c$  determines the reference current for both the vertical sawtooth generator and the geometry processor. The preferred value of  $R_c$  is 39 k $\Omega$  which results in a reference current of 100  $\mu$ A ( $V_{ref} = 3.9$  V).

The value of  $R_{EW}$  must be:

$$R_{EW} = R_c \times \frac{V_{scan}}{18 \times V_{ref}}$$

Example: With  $V_{ref} = 3.9$  V;  $R_c = 39$  k $\Omega$  and  $V_{scan} = 120$  V then  $R_{EW} = 68$  k $\Omega$ .

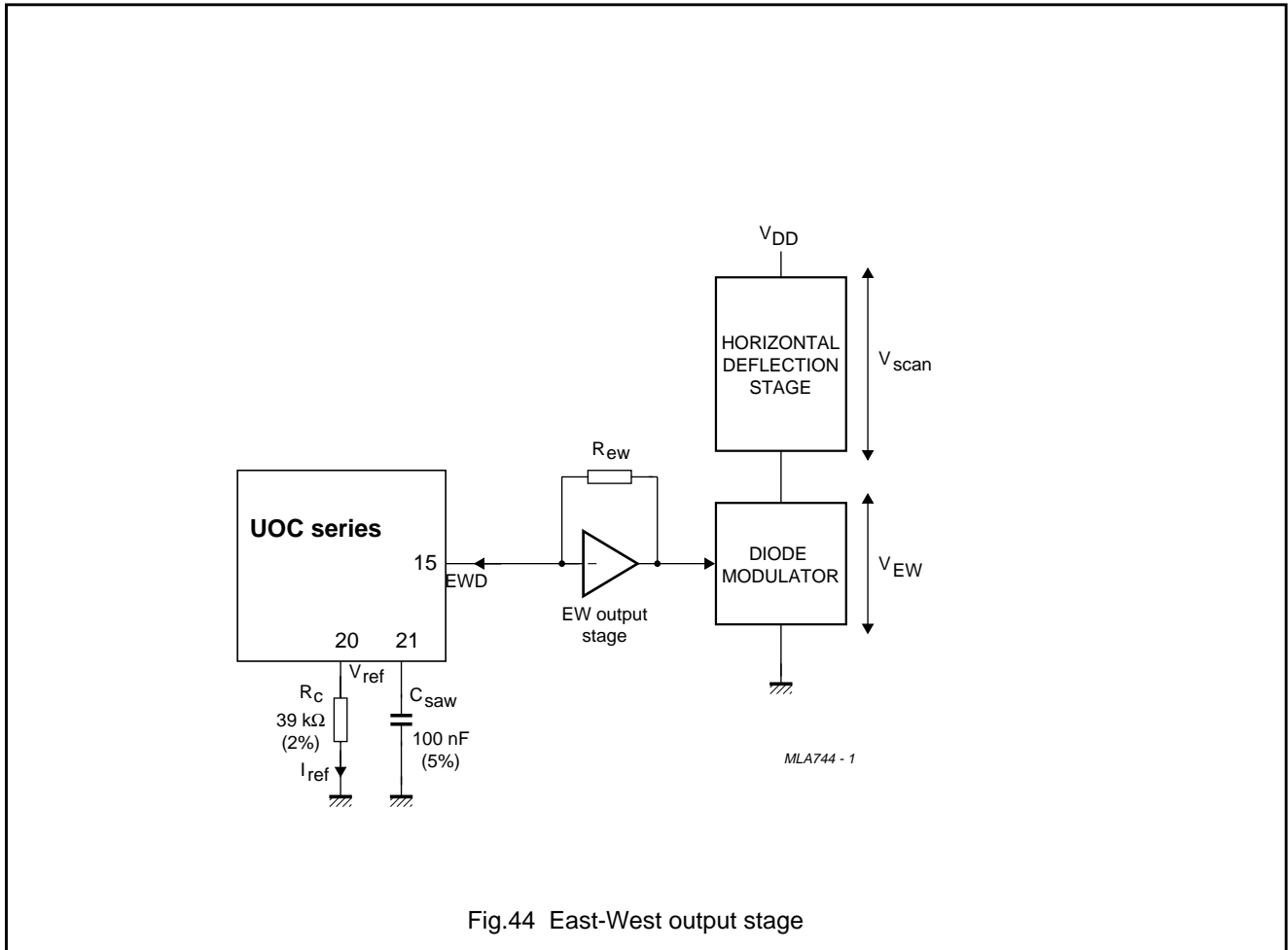
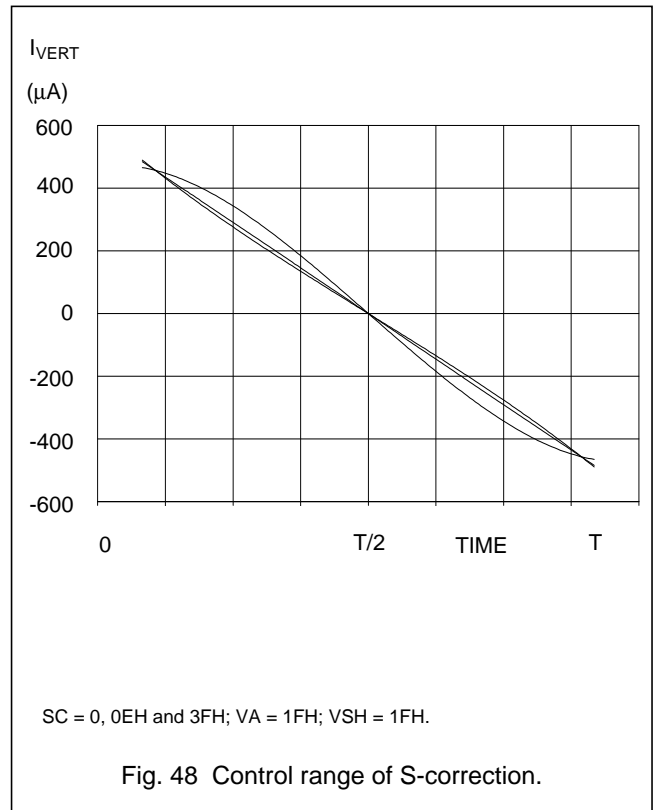
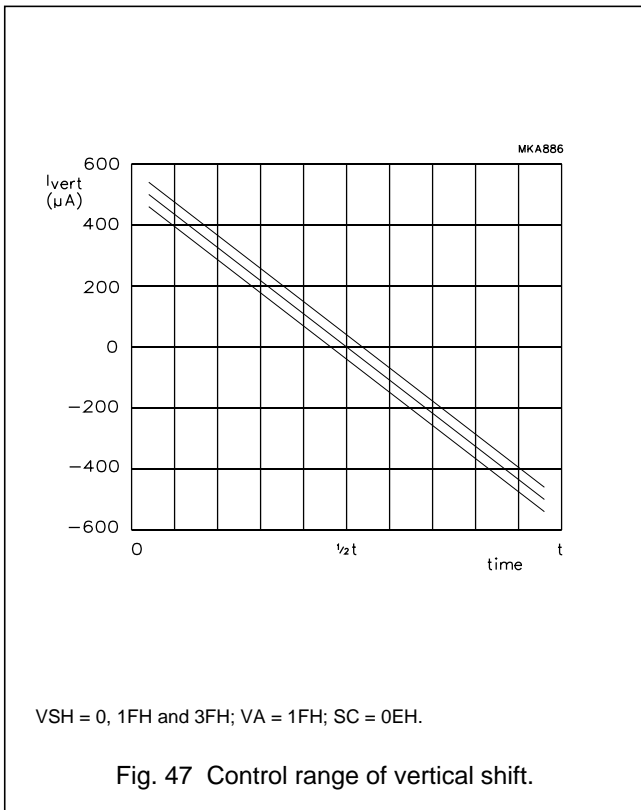
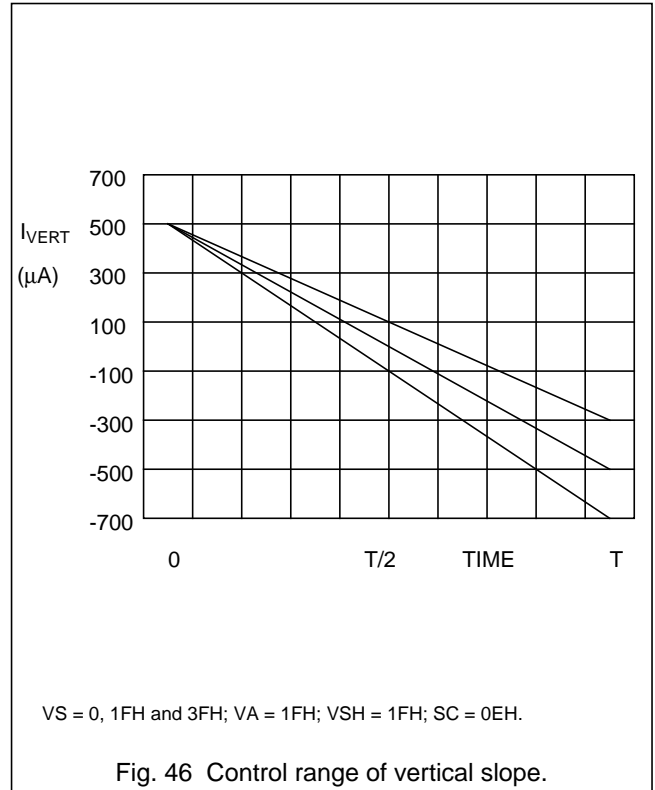
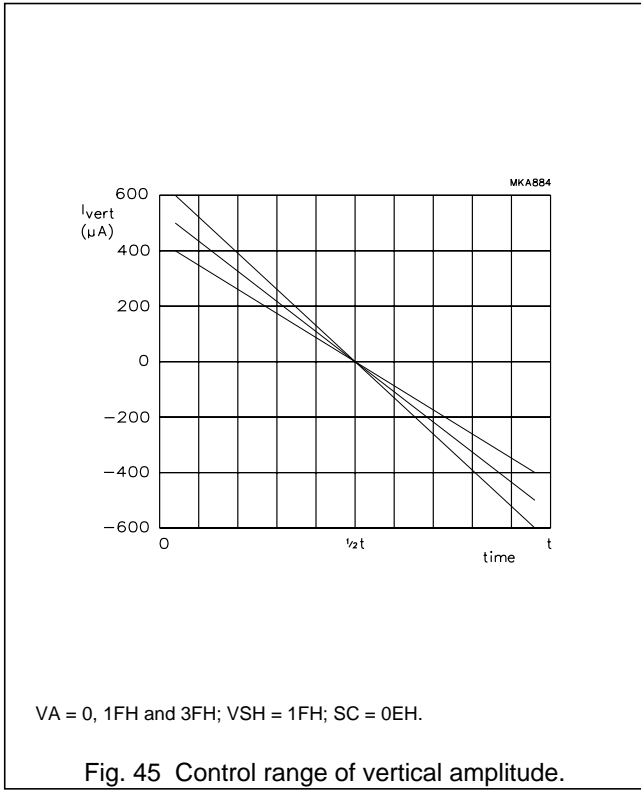

Fig.44 East-West output stage

TV signal processor-Teletext decoder with embedded  $\mu$ -Controller

TDA935X/6X/8X PS/N2 series



TV signal processor-Teletext decoder with embedded  $\mu$ -Controller

TDA935X/6X/8X PS/N2 series

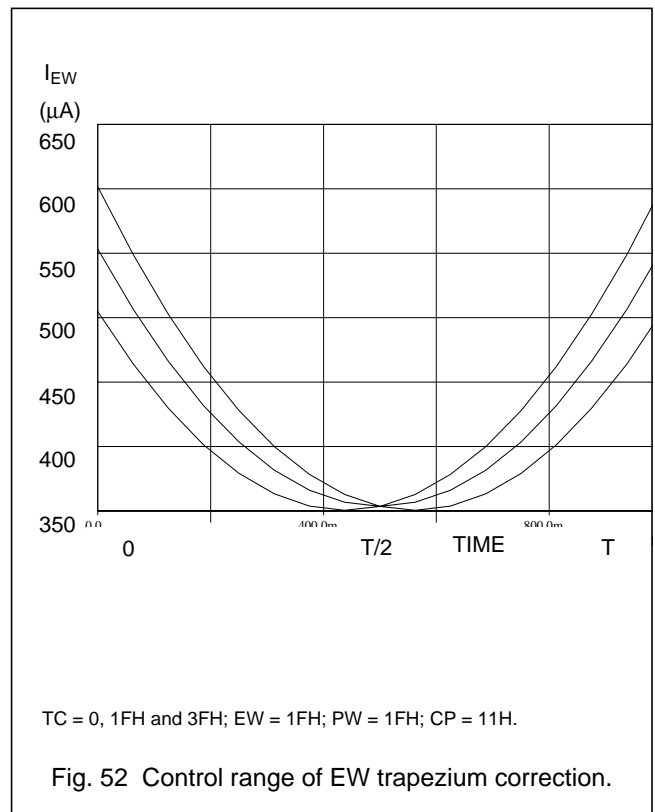
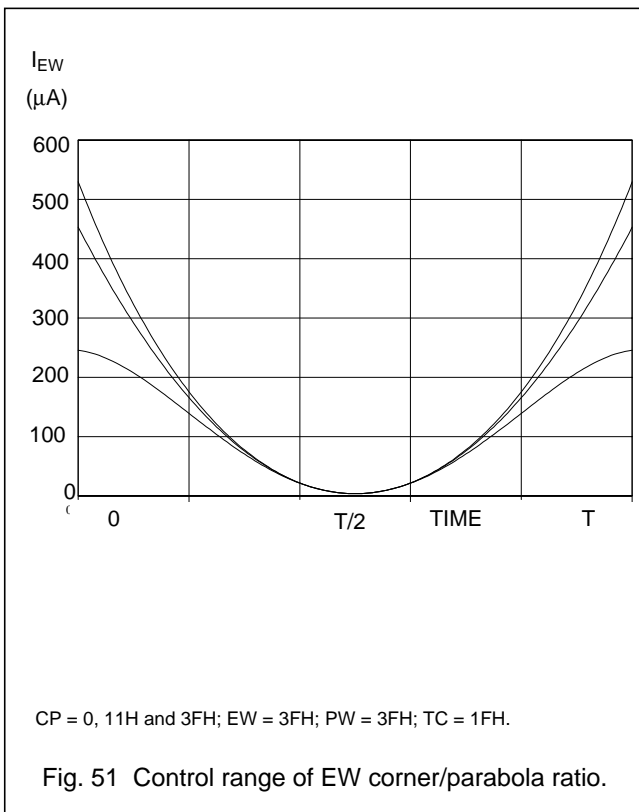
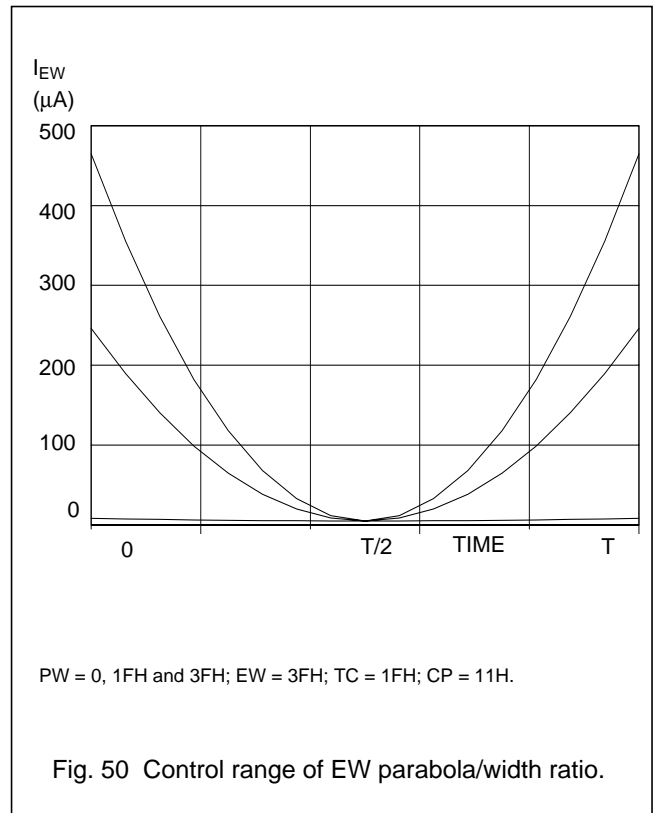
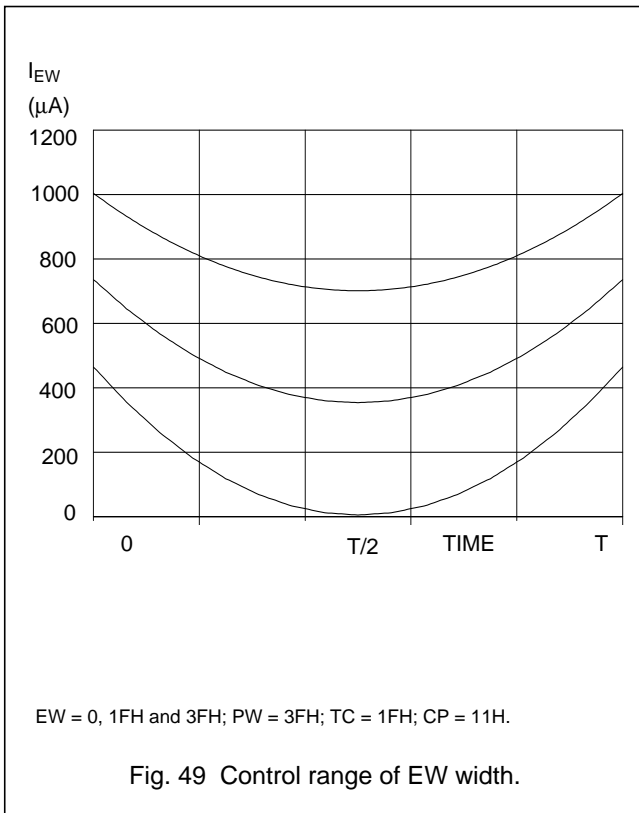



## TV signal processor-Teletext decoder with embedded $\mu$ -Controller

## TDA935X/6X/8X PS/N2 series

### Adjustment of geometry control parameters

The deflection processor offers 5 control parameters for picture alignment, viz:

- S-correction
- vertical amplitude
- vertical slope
- vertical shift
- horizontal shift.

The 110° types offer in addition:

- EW width
- EW parabola width
- EW upper/lower corner parabola
- EW trapezium correction.
- Vertical zoom
- Horizontal parallelogram and bow correction

It is important to notice that the ICs are designed for use with a DC-coupled vertical deflection stage. This is the reason why a vertical linearity alignment is not necessary (and therefore not available).

For a particular combination of picture tube type, vertical output stage and EW output stage it is determined which are the required values for the settings of S-correction, EW parabola/width ratio and EW corner/parabola ratio. These parameters can be preset via the I<sup>2</sup>C-bus, and do not need any additional adjustment. The rest of the parameters are preset with the mid-value of their control range (i.e. 1FH), or with the values obtained by previous TV-set adjustments.

The vertical shift control is meant for compensation of off-sets in the external vertical output stage or in the picture tube. It can be shown that without compensation these off-sets will result in a certain linearity error, especially with picture tubes that need large S-correction. The total linearity error is in first order approximation proportional to the value of the off-set, and to the square of the S-correction needed. The necessity to use the vertical shift alignment depends on the expected off-sets in vertical output stage and picture tube, on the required value of the S-correction, and on the demands upon vertical linearity.

For adjustment of the vertical shift and vertical slope independent of each other, a special service blanking mode can be entered by setting the SBL bit HIGH. In this mode the RGB-outputs are blanked during the second half of the picture. There are 2 different methods for alignment of the picture in vertical direction. Both methods make use of the service blanking mode.

The first method is recommended for picture tubes that have a marking for the middle of the screen. With the vertical shift control the last line of the visible picture is positioned exactly in the middle of the screen. After this adjustment the vertical shift should not be changed. The top of the picture is placed by adjustment of the vertical amplitude, and the bottom by adjustment of the vertical slope.

The second method is recommended for picture tubes that have no marking for the middle of the screen. For this method a video signal is required in which the middle of the picture is indicated (e.g. the white line in the circle test pattern). With the vertical slope control the beginning of the blanking is positioned exactly on the middle of the picture. Then the top and bottom of the picture are placed symmetrical with respect to the middle of the screen by adjustment of the vertical amplitude and vertical shift. After this adjustment the vertical shift has the right setting and should not be changed.

If the vertical shift alignment is not required VSH should be set to its mid-value (i.e. VSH = 1F). Then the top of the picture is placed by adjustment of the vertical amplitude and the bottom by adjustment of the vertical slope. After the vertical picture alignment the picture is positioned in the horizontal direction by adjustment of the EW width and the horizontal shift. Finally (if necessary) the left- and right-hand sides of the picture are aligned in parallel by adjusting the EW trapezium control.

To obtain the full range of the vertical zoom function the adjustment of the vertical geometry should be carried out at a nominal setting of the zoom DAC at position 19 HEX.

TV signal processor-Teletext decoder with embedded  $\mu$ -Controller

TDA935X/6X/8X PS/N2 series

PACKAGE OUTLINE

DIP64: plastic shrink dual in-line package; 64 leads (750 mil)

SOT274-1

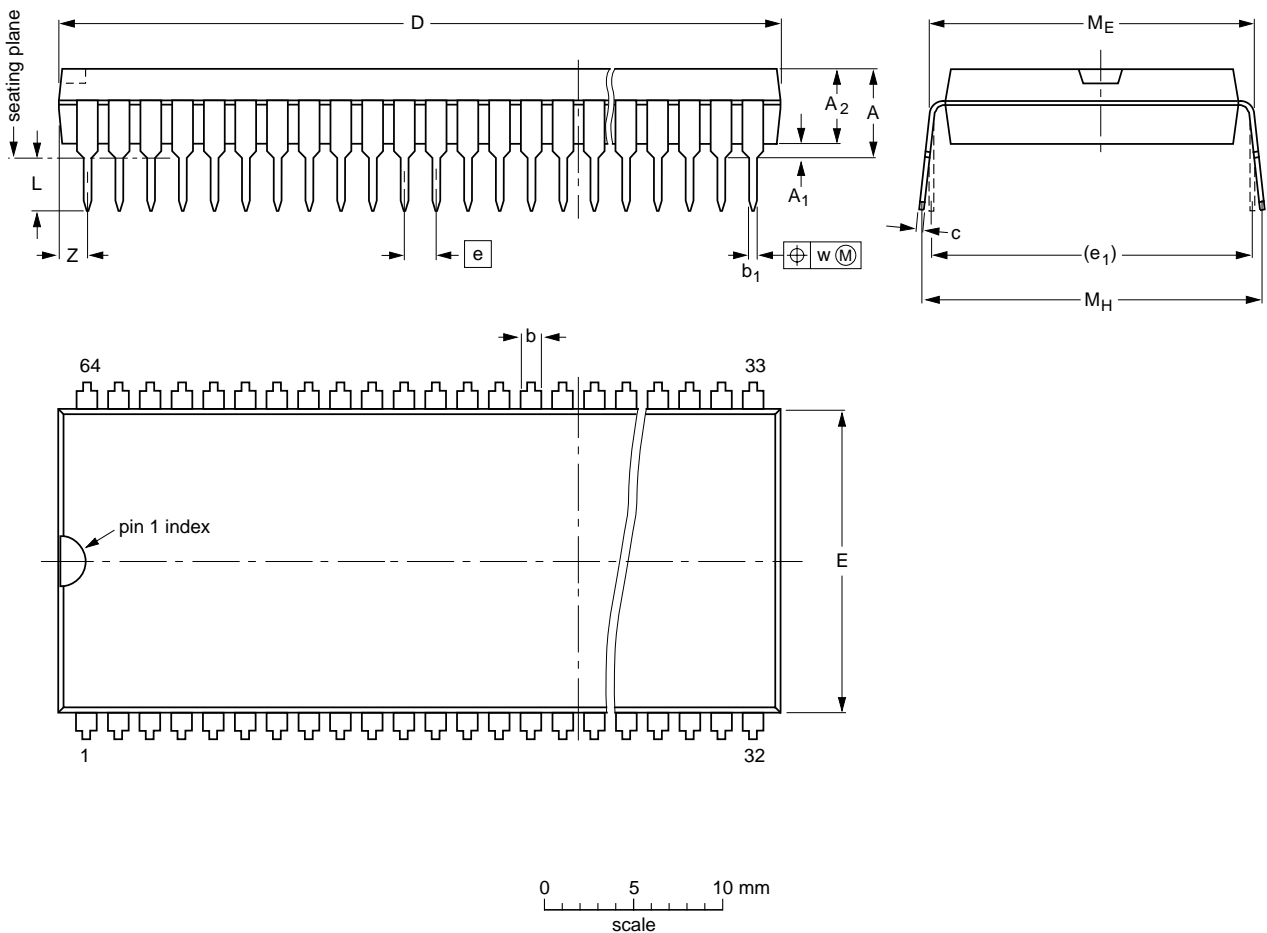

DIMENSIONS (mm are the original dimensions)

UNIT	A max.	A <sub>1</sub> min.	A <sub>2</sub> max.	b	b <sub>1</sub>	c	D <sup>(1)</sup>	E <sup>(1)</sup>	e	e <sub>1</sub>	L	M <sub>E</sub>	M <sub>H</sub>	w	Z <sup>(1)</sup> max.
mm	5.84	0.51	4.57	1.3 0.8	0.53 0.40	0.32 0.23	58.67 57.70	17.2 16.9	1.778	19.05	3.2 2.8	19.61 19.05	20.96 19.71	0.18	1.73

Note

1. Plastic or metal protrusions of 0.25 mm maximum per side are not included.

OUTLINE VERSION	REFERENCES				EUROPEAN PROJECTION	ISSUE DATE
	IEC	JEDEC	EIAJ			
SOT274-1						-92-10-13- 95-02-04

# TV signal processor-Teletext decoder with embedded $\mu$ -Controller

## TDA935X/6X/8X PS/N2 series

### SOLDERING

#### Introduction

There is no soldering method that is ideal for all IC packages. Wave soldering is often preferred when through-hole and surface mounted components are mixed on one printed-circuit board. However, wave soldering is not always suitable for surface mounted ICs, or for printed-circuits with high population densities. In these situations reflow soldering is often used.

This text gives a very brief insight to a complex technology. A more in-depth account of soldering ICs can be found in our "IC package Databook" (order code 9398 652 90011).

#### SDIP

##### SOLDERING BY DIPPING OR BY WAVE

The maximum permissible temperature of the solder is 260 °C; solder at this temperature must not be in contact with the joint for more than 5 seconds. The total contact time of successive solder waves must not exceed 5 seconds.

The device may be mounted up to the seating plane, but the temperature of the plastic body must not exceed the specified maximum storage temperature ( $T_{stg\ max}$ ). If the printed-circuit board has been pre-heated, forced cooling may be necessary immediately after soldering to keep the temperature within the permissible limit.

##### REPAIRING SOLDERED JOINTS

Apply a low voltage soldering iron (less than 24 V) to the lead(s) of the package, below the seating plane or not more than 2 mm above it. If the temperature of the soldering iron bit is less than 300 °C it may remain in contact for up to 10 seconds. If the bit temperature is between 300 and 400 °C, contact may be up to 5 seconds.

#### QFP

##### REFLOW SOLDERING

Reflow soldering techniques are suitable for all QFP packages.

The choice of heating method may be influenced by larger plastic QFP packages (44 leads, or more). If infrared or vapour phase heating is used and the large packages are not absolutely dry (less than 0.1% moisture content by weight), vaporization of the small amount of moisture in them can cause cracking of the plastic body. For details, refer to the Drypack information in our "Quality Reference Handbook" (order code 9397 750 00192).

Reflow soldering requires solder paste (a suspension of fine solder particles, flux and binding agent) to be applied to the printed-circuit board by screen printing, stencilling or pressure-syringe dispensing before package placement.

Several methods exist for reflowing; for example, infrared/convection heating in a conveyor type oven. Throughput times (preheating, soldering and cooling) vary between 50 and 300 seconds depending on heating method. Typical reflow peak temperatures range from 215 to 250 °C.

##### WAVE SOLDERING

Wave soldering is **not** recommended for QFP packages. This is because of the likelihood of solder bridging due to closely-spaced leads and the possibility of incomplete solder penetration in multi-lead devices.

**If wave soldering cannot be avoided, for QFP packages with a pitch (e) larger than 0.5 mm, the following conditions must be observed:**

- **A double-wave (a turbulent wave with high upward pressure followed by a smooth laminar wave) soldering technique should be used.**
- **The footprint must be at an angle of 45° to the board direction and must incorporate solder thieves downstream and at the side corners.**

During placement and before soldering, the package must be fixed with a droplet of adhesive. The adhesive can be applied by screen printing, pin transfer or syringe dispensing. The package can be soldered after the adhesive is cured.

Maximum permissible solder temperature is 260 °C, and maximum duration of package immersion in solder is 10 seconds, if cooled to less than 150 °C within 6 seconds. Typical dwell time is 4 seconds at 250 °C.

A mildly-activated flux will eliminate the need for removal of corrosive residues in most applications.

##### REPAIRING SOLDERED JOINTS

Fix the component by first soldering two diagonally-opposite end leads. Use only a low voltage soldering iron (less than 24 V) applied to the flat part of the lead. Contact time must be limited to 10 seconds at up to 300 °C. When using a dedicated tool, all other leads can be soldered in one operation within 2 to 5 seconds between 270 and 320 °C.

# TV signal processor-Teletext decoder with embedded $\mu$ -Controller

## TDA935X/6X/8X PS/N2 series

### DEFINITIONS

<b>Data sheet status</b>	
Objective specification	This data sheet contains target or goal specifications for product development.
Preliminary specification	This data sheet contains preliminary data; supplementary data may be published later.
Product specification	This data sheet contains final product specifications.
<b>Limiting values</b>	
Limiting values given are in accordance with the Absolute Maximum Rating System (IEC 134). Stress above one or more of the limiting values may cause permanent damage to the device. These are stress ratings only and operation of the device at these or at any other conditions above those given in the Characteristics sections of the specification is not implied. Exposure to limiting values for extended periods may affect device reliability.	
<b>Application information</b>	
Where application information is given, it is advisory and does not form part of the specification.	

### LIFE SUPPORT APPLICATIONS

These products are not designed for use in life support appliances, devices, or systems where malfunction of these products can reasonably be expected to result in personal injury. Philips customers using or selling these products for use in such applications do so at their own risk and agree to fully indemnify Philips for any damages resulting from such improper use or sale.

### PURCHASE OF PHILIPS I<sup>2</sup>C COMPONENTS



Purchase of Philips I<sup>2</sup>C components conveys a license under the Philips' I<sup>2</sup>C patent to use the components in the I<sup>2</sup>C system provided the system conforms to the I<sup>2</sup>C specification defined by Philips. This specification can be ordered using the code 9398 393 40011.