

SANYO	No.341G	2SB632,632K/2SD612,612K
		PNP/NPN Epitaxial Planar Silicon Transistors 25V/35V, 2A Low-Frequency Power Amp Applications

Features

- High collector dissipation and wide ASO.

(): 2SB632, 632K

Absolute Maximum Ratings at Ta = 25°C		2SB632, D612	2SB632K, D612K	unit
Collector-to-Base Voltage	V _{CB0}	(-)25	(-)35	V
Collector-to-Emitter Voltage	V _{CE0}	(-)25	(-)35	V
Emitter-to-Base Voltage	V _{EBO}		(-)5	V
Collector Current	I _C	(-)2		A
Collector Current (Pulse)	I _{CP}	(-)3		A
Collector Dissipation	P _C		1	W
			10	W
Junction Temperature	T _j		150	°C
Storage Temperature	T _{stg}		-55 to +150	°C

Electrical Characteristics at Ta = 25°C			min	typ	max	unit
C-B Breakdown Voltage	V _{(BR)CBO}	I _C = (-)10μA, I _E = 0	B632, D612 (-)25			V
			B632K, D612K (-)35			V
C-E Breakdown Voltage	V _{(BR)CEO}	I _C = (-)1mA, R _{BE} = ∞	B632, D612 (-)25			V
			B632K, D612K (-)35			V
E-B Breakdown Voltage	V _{(BR)EBO}	I _E = (-)10μA, I _C = 0	(-)5			V
Collector Cutoff Current	I _{CBO}	V _{CB} = (-)20V, I _E = 0			(-)1	μA
Emitter Cutoff Current	I _{EBO}	V _{EB} = (-)4V, I _C = 0			(-)1	μA
DC Current Gain	h _{FE} (1)	V _{CE} = (-)2V, I _C = (-)500mA	60※		320※	
	h _{FE} (2)	V _{CE} = (-)2V, I _C = (-)1.5A	30			
Gain-Bandwidth Product	f _T	V _{CE} = (-)10V, I _C = (-)50mA		100		MHz
Output Capacitance	C _{ob}	V _{CB} = (-)10V, f = 1MHz		(45)30		pF
C-E Saturation Voltage	V _{CE(sat)}	I _C = (-)1.5A, I _B = (-)0.15A		(-0.4)(-0.9)		V
				0.3	0.8	
B-E Saturation Voltage	V _{BE(sat)}	I _C = (-)1.5A, I _B = (-)0.15A		(-)1.1(-)1.5		V
Turn-ON Time	t _{on}	See specified Test Circuit.		(60)50		ns
Fall Time	t _f	"		(80)100		ns
Storage Time	t _{stg}	"		400		ns

※ : The 2SB632/2SD612 are classified by 500mA h_{FE} as follows.

60	D	120	100	E	200	160	F	320
----	---	-----	-----	---	-----	-----	---	-----

Switching Time Test Circuit

(For PNP, the polarity is reversed.)

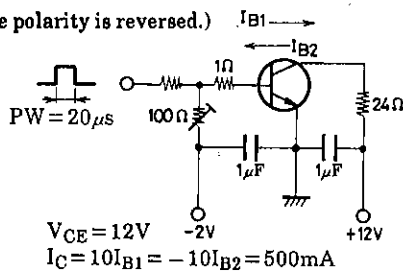

Package Dimensions 2009B

(unit : mm)

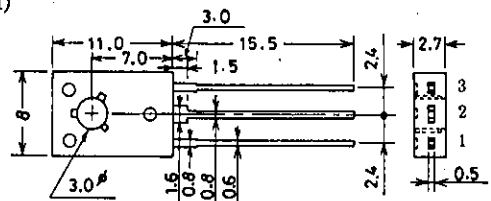

JEDEC: TO-126

- 1: Emitter
- 2: Collector
- 3: Base

SANYO Electric Co., Ltd. Semiconductor Business Headquarters

TOKYO OFFICE Tokyo Bldg., 1-10, 1 Chome, Ueno, Taito-ku, TOKYO, 110 JAPAN

2SB632, 632K/2SD612, 612K

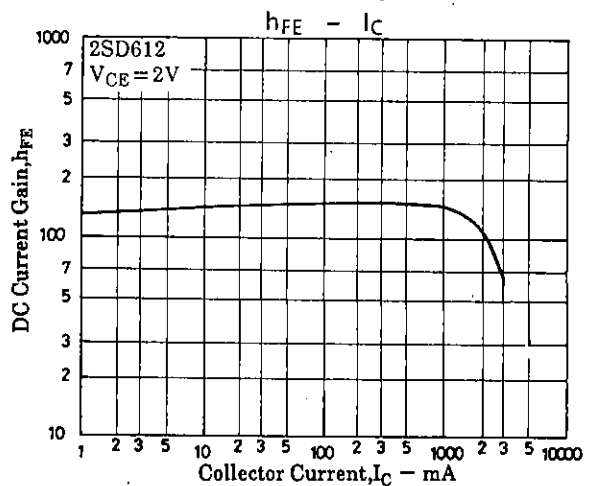
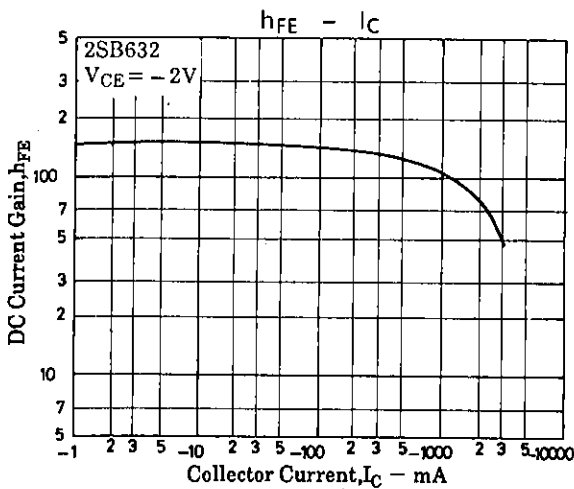
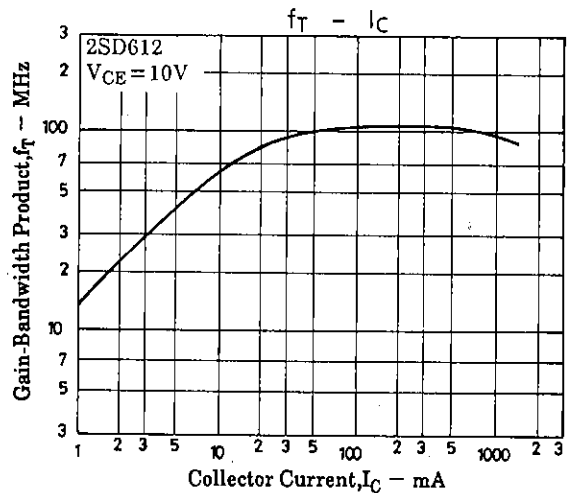
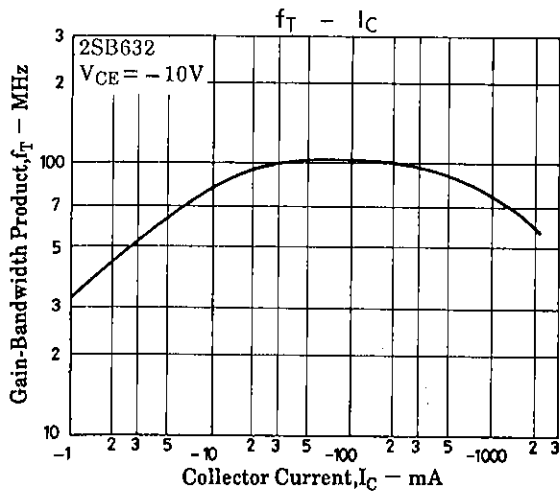
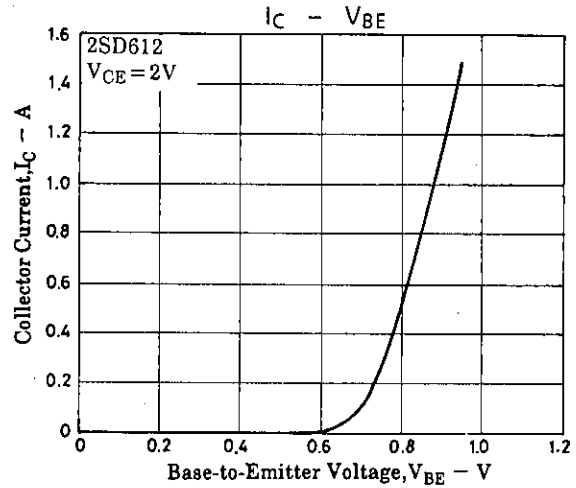
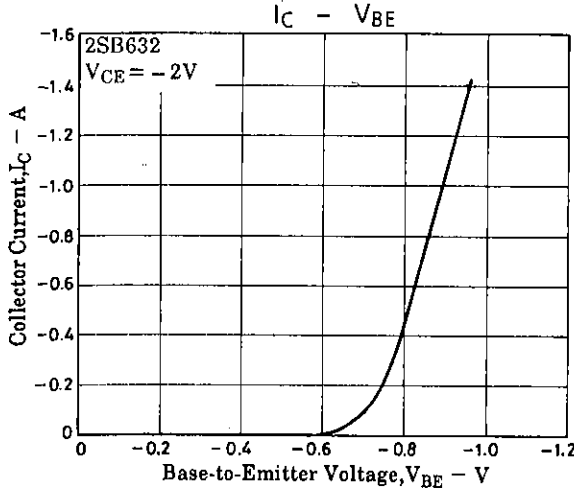
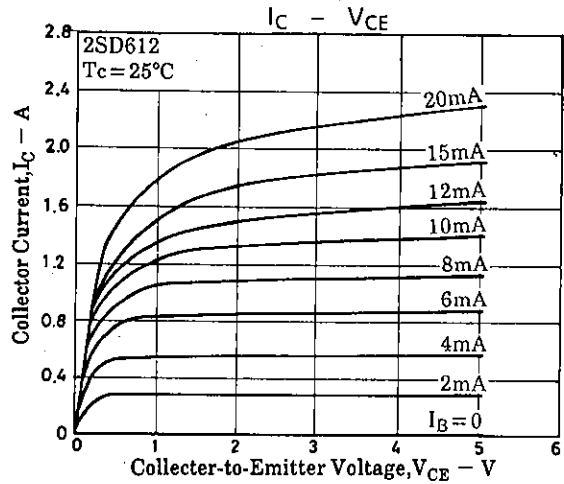
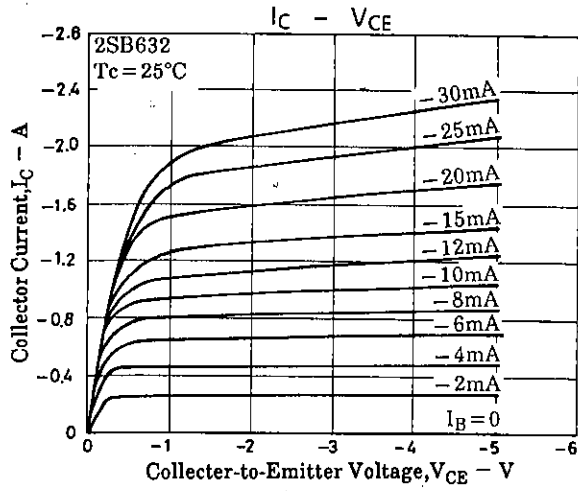

2SB632, 632K/2SD612, 612K

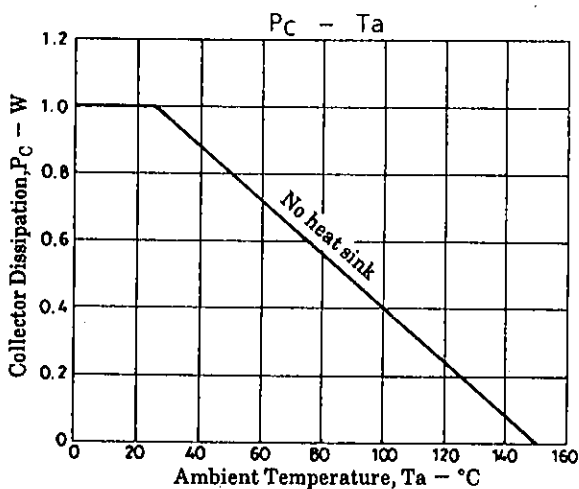
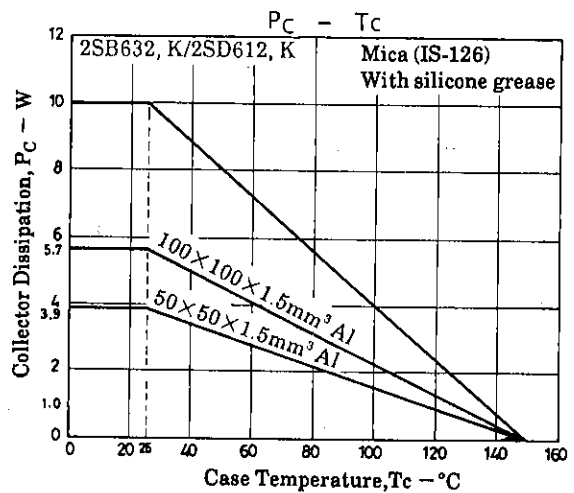
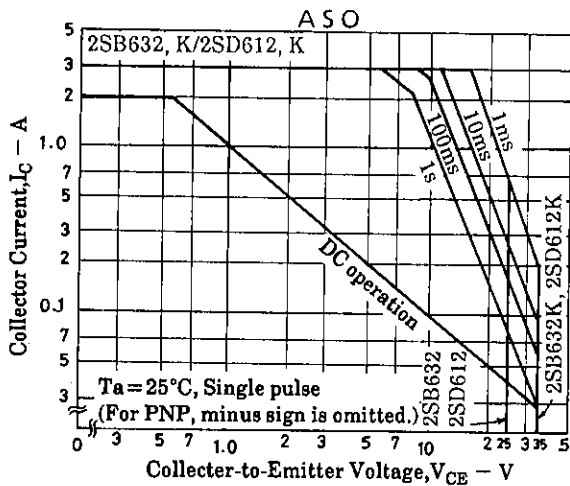
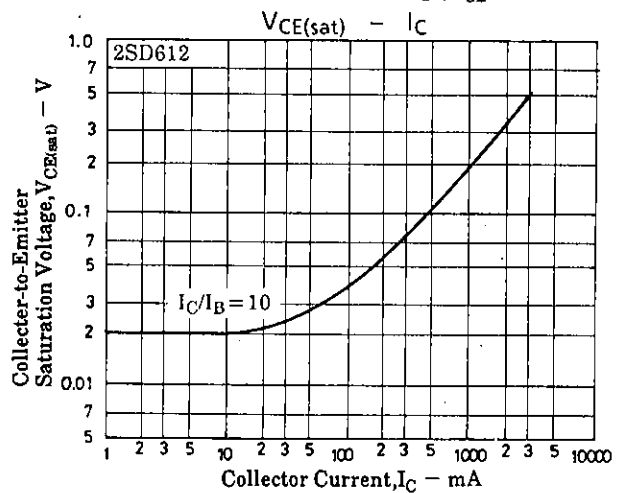
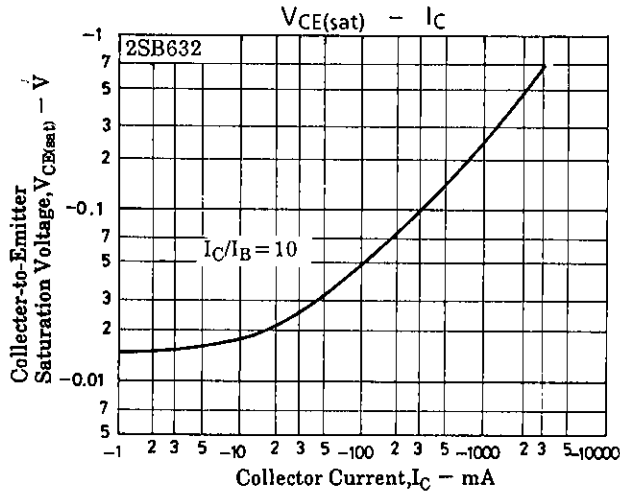
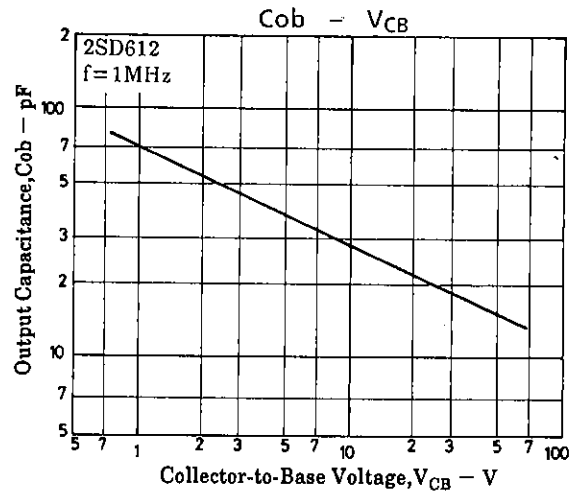
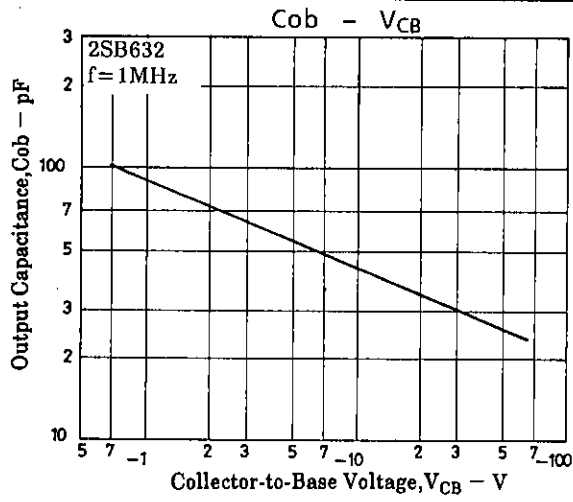

2SB632, 632K/2SD612, 612K

Sample Application Circuit 1 : 8W pure complementary amplifier using the 2SB632K/2SD612K
 [Specifications] Power supply : 100V AC supply transformer with no signal = 28.8V,
 Maximum output = (THD = 5%) = 25V, $f = 1\text{kHz}$, $R_L = 8\Omega$, $R_g = 600\Omega$

			typ	uint
Quiescent Current (Collector Current)	I_{CC0}	Output stage	14.0	mA
	I_D	Drive stage	42.0	mA
	I_C	First stage	1.4	mA
Voltage Gain	VG	Without NFB	75	dB
	VG	With NFB	40	dB
Output Power	P_O	THD = 5%	8.7	W
Total Harmonic Distortion	THD	$P_O = 1\text{W}$	0.05	%
Input Resistance	r_i	$P_O = 1\text{W}$	60	k Ω
Output Resistance	r_o	$P_O = 1\text{W}$	0.2	Ω

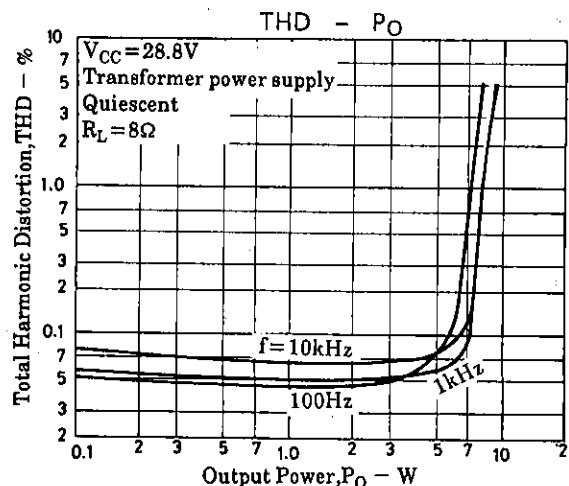
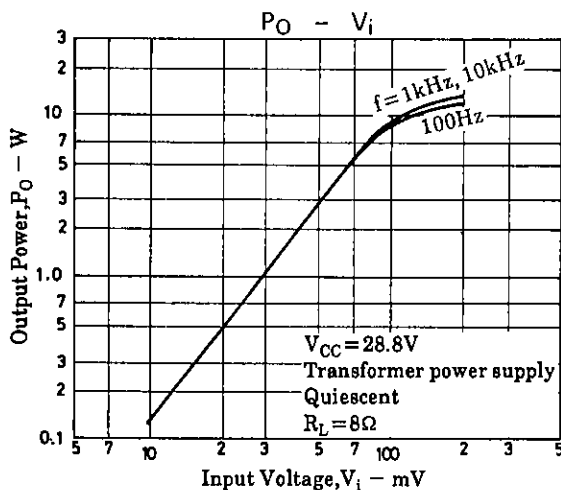
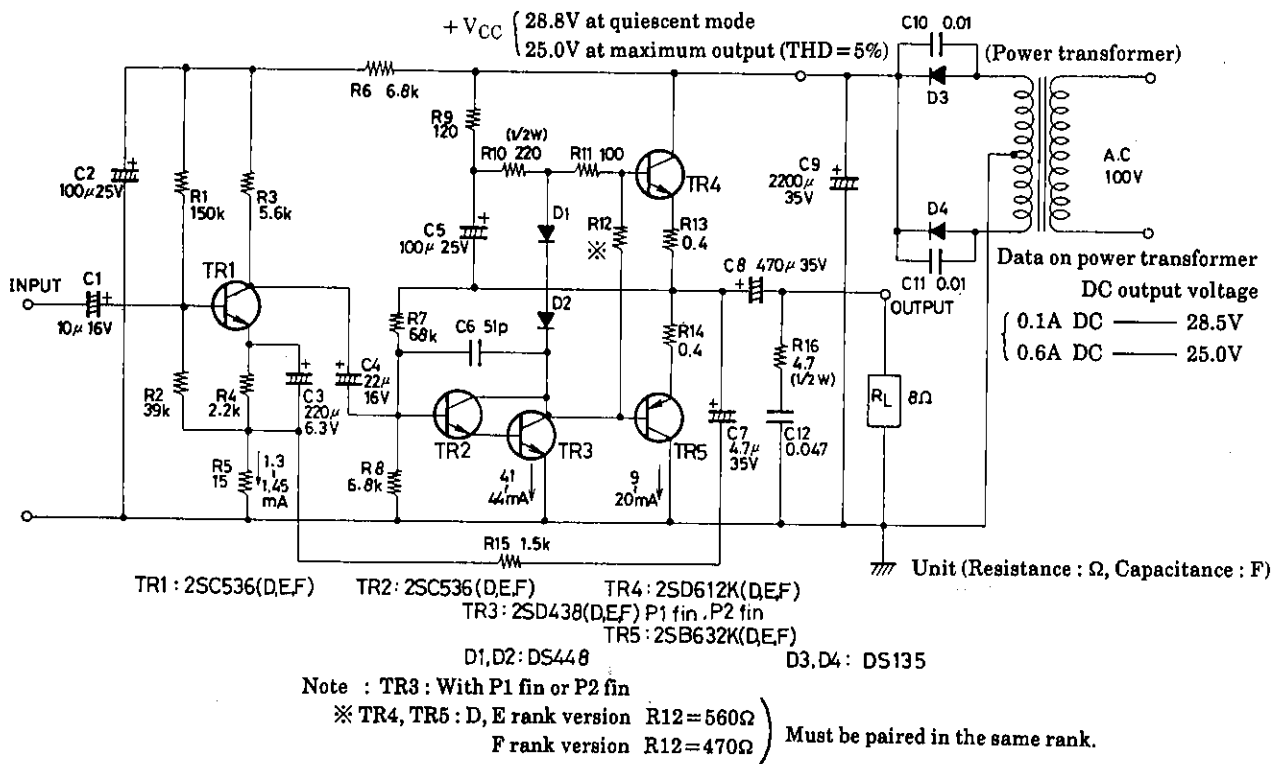

2SB632, 632K/2SD612, 612K

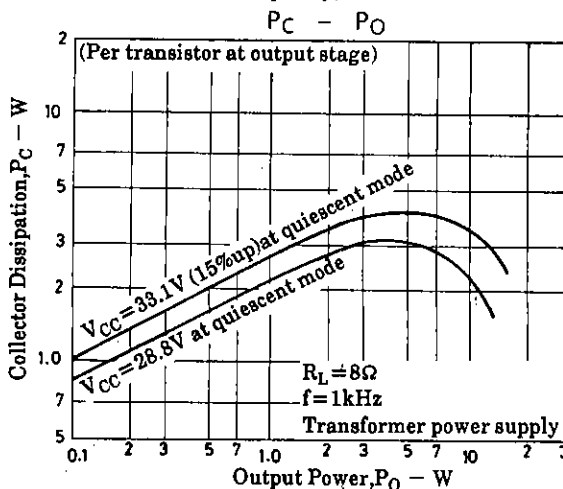
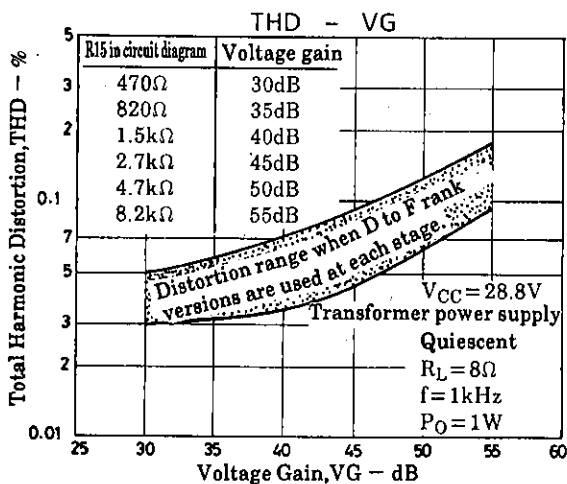
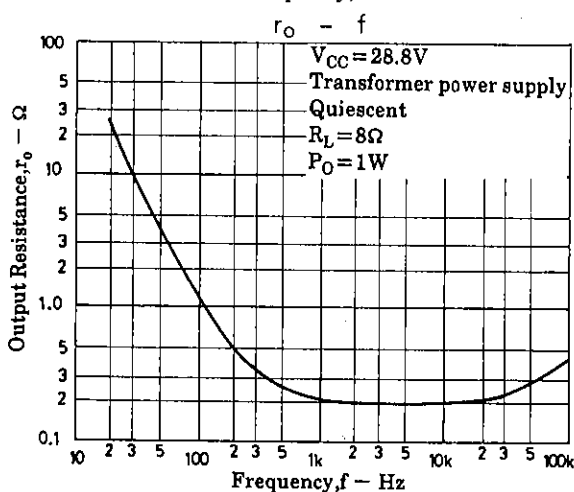
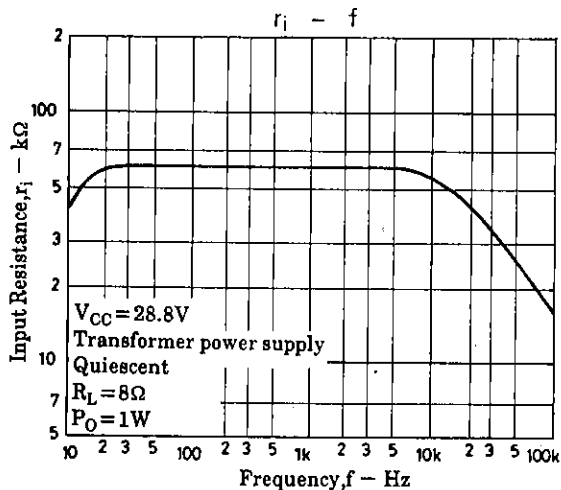
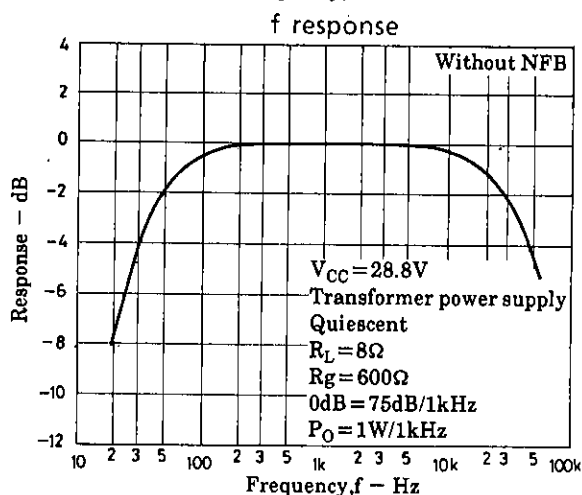
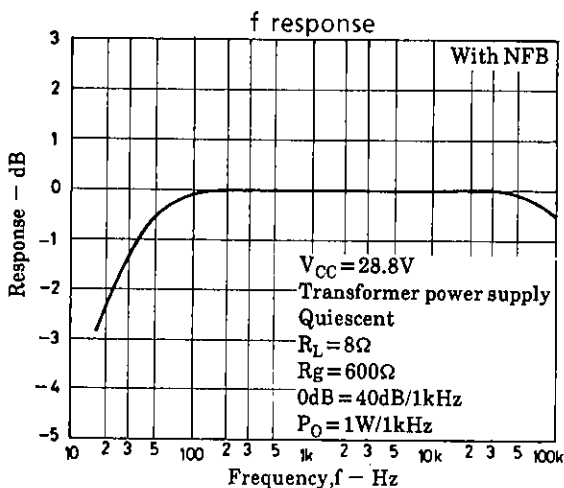
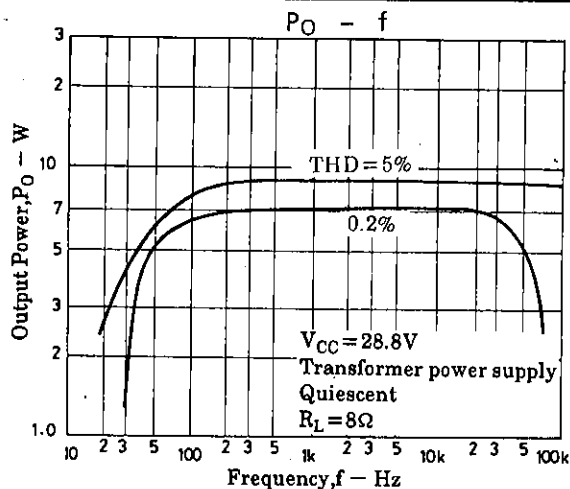
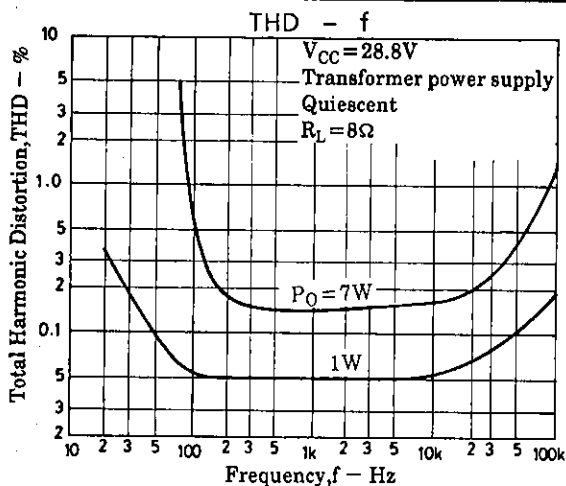

2SB632, 632K/2SD612, 612K

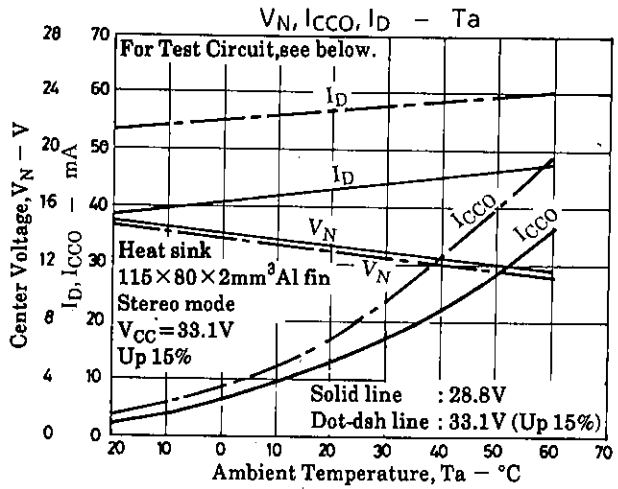
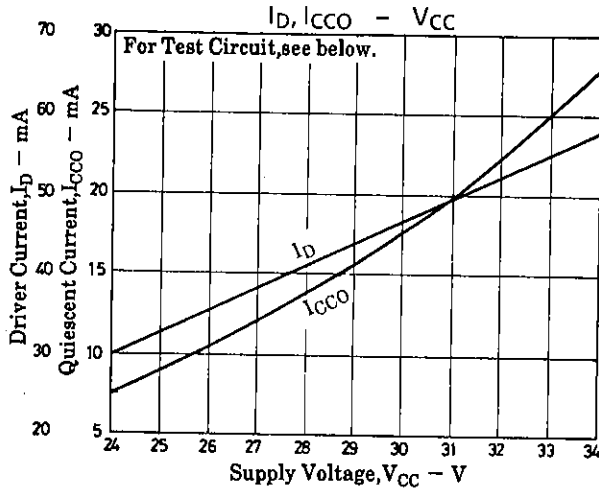

Sample Application Circuit 2 : 2SD612-Used 4W Input Transformer Coupling Amp for Car Use.

[Specifications] $V_{CC} = 13.2 \text{ V}$, $R_L = 4 \Omega$, $R_g = 600 \Omega$, $f = 1 \text{ kHz}$

Quiescent Current (Collector Current)	I_{CCO}	Output stage	12.0	mA
	I_D	Drive stage	9.0	mA
Voltage Gain	V_G	Without NFB	66	dB
	V_G	With NFB	49	dB
Output Power	P_O	THD = 10%	4.7	W
Total Harmonic Distortion	THD	$P_O = 0.5 \text{ W}$	0.8	%
Input impedance	r_i	$P_O = 0.5 \text{ W}$	60	k Ω

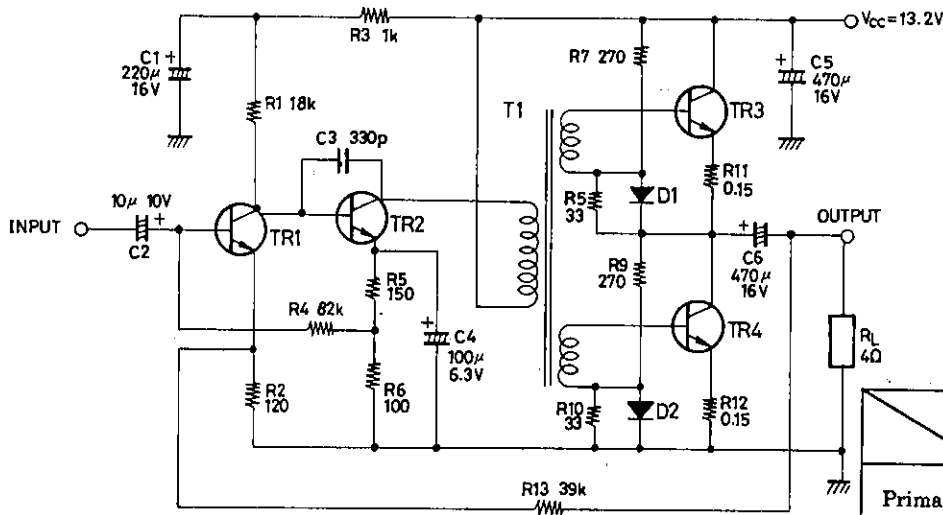
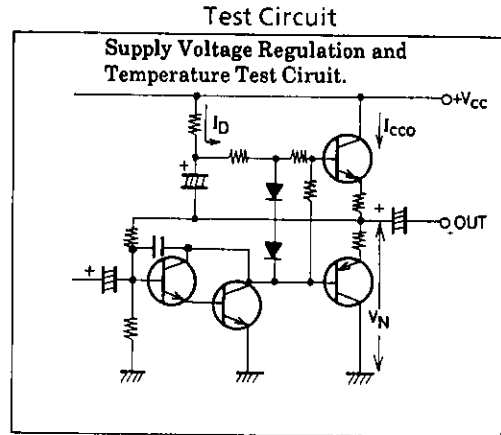

Data on transformer (T1)

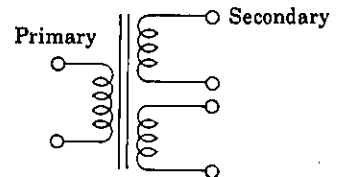

	Impedance	DC resistance
Primary	3k Ω	180 Ω
Secondary	400 Ω	18 Ω

(Must be paired in the same rank).

Unit (Resistance : Ω , Capacitance : F)

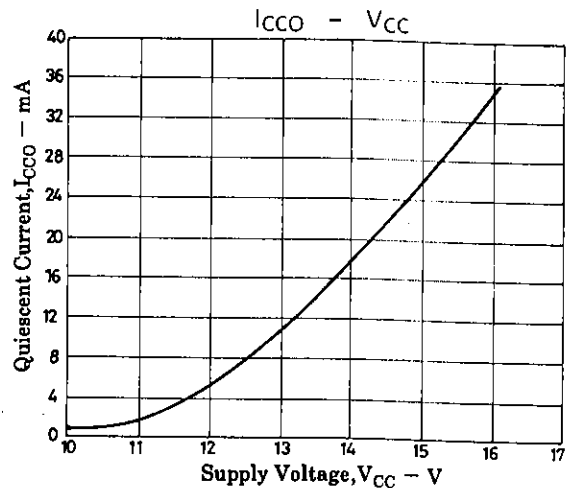
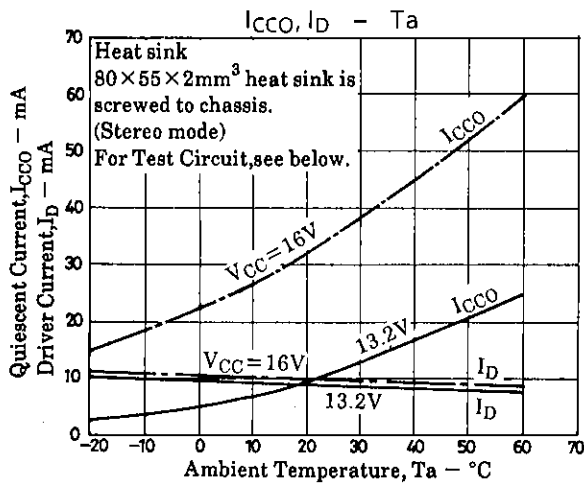
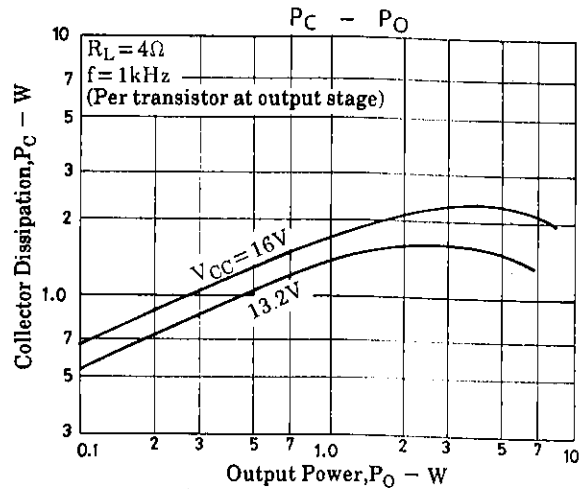
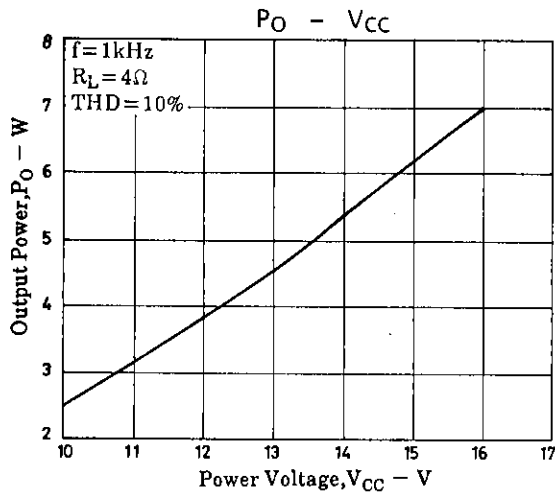
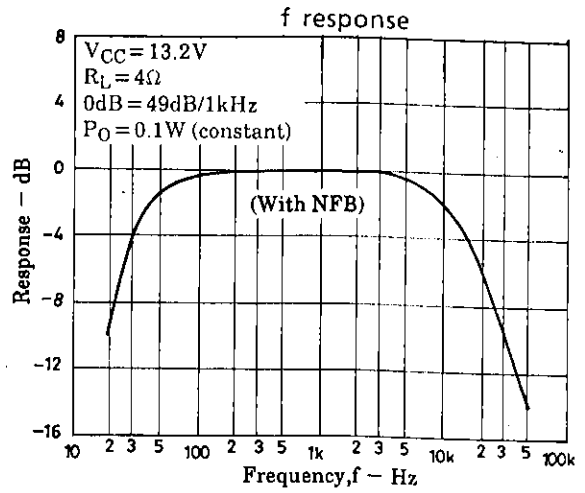
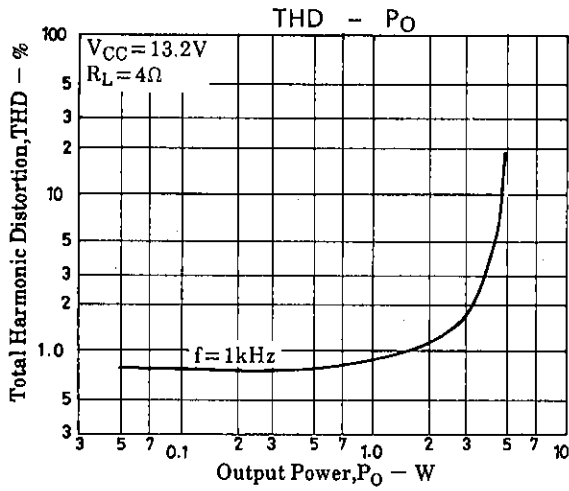

Test Circuit

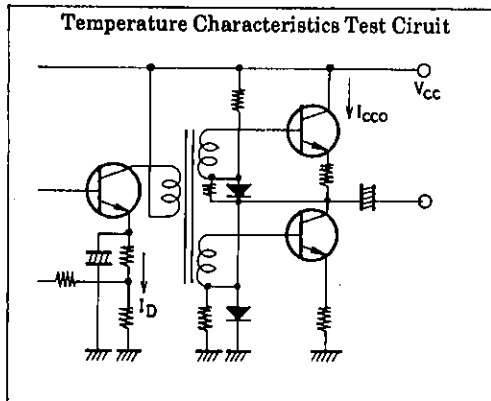

- No products described or contained herein are intended for use in surgical implants, life-support systems, aerospace equipment, nuclear power control systems, vehicles, disaster/crime-prevention equipment and the like, the failure of which may directly or indirectly cause injury, death or property loss.
- Anyone purchasing any products described or contained herein for an above-mentioned use shall:
 - ① Accept full responsibility and indemnify and defend SANYO ELECTRIC CO., LTD., its affiliates, subsidiaries and distributors and all their officers and employees, jointly and severally, against any and all claims and litigation and all damages, cost and expenses associated with such use:
 - ② Not impose any responsibility for any fault or negligence which may be cited in any such claim or litigation on SANYO ELECTRIC CO., LTD., its affiliates, subsidiaries and distributors or any of their officers and employees jointly or severally.
- Information (including circuit diagrams and circuit parameters) herein is for example only; it is not guaranteed for volume production. SANYO believes information herein is accurate and reliable, but no guarantees are made or implied regarding its use or any infringements of intellectual property rights or other rights of third parties.

This catalog provides information as of September, 1995. Specifications and information herein are subject to change without notice.