

TBA810SH/AS ✓

7W AUDIO POWER AMPLIFIER

■ FEATURES

- Low Noise
 - 1.7 μ V typ, 3.3 μ V max, total input noise.
 - ($V_{CC} = 15V$, $R_g = 7.7 k\Omega$, see test circuit)
 - where R_g : Signal Source Resistance for IC
- High Output Power
 - 7W typ ($V_{CC} = 16V$, $R_L = 4\Omega$, T.H.D. = 10%)
 - 6W typ ($V_{CC} = 14.4V$, $R_L = 4\Omega$, T.H.D. = 10%)
 - 2.5W typ ($V_{CC} = 9V$, $R_L = 4\Omega$, T.H.D. = 10%)
 - 1W typ ($V_{CC} = 6V$, $R_L = 4\Omega$, T.H.D. = 10%)
- Wide Range of Supply Voltage from 4 to 20V
- High Output Current up to 2.5A
- High Efficiency 75% at 6W Output
- Very Low Harmonic and Crossover Distortion
- TBA810S-H is provided with a thermal limiting circuit which fundamentally changes the criteria normally used in determining size of the heat sink.

TBA810SH

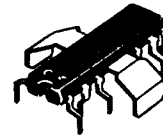

65.2

(QP-12T)

TBA810AS

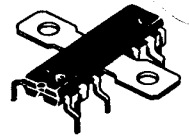

65.7

(QP-12TA)

■ PIN CONNECTION (Top View)

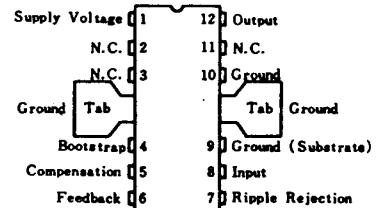

■ CIRCUIT SCHEMATIC

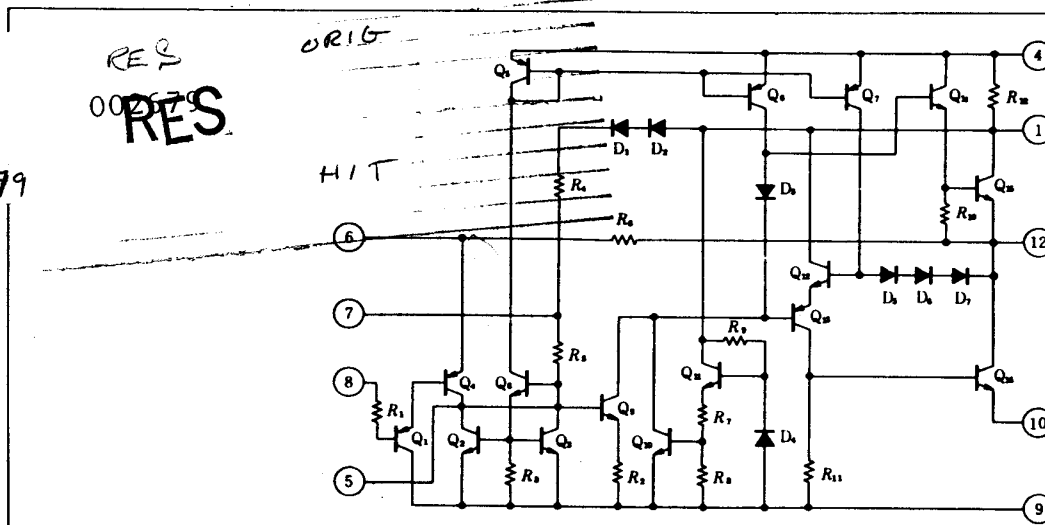

no ov protection per Bob

■ ABSOLUTE MAXIMUM RATINGS ($T_a = 25^\circ C$)

Item	Symbol	Rating	Unit
Supply Voltage	V_{CC}	20	V
Output Peak Current (nonrepetitive)	$I_{O(peak)}$	3.5	A
Output Current (repetitive)	I_O	2.5	A
Power Dissipation	when $T_a = 80^\circ C$	1	W
	when $T_{rob} = 100^\circ C$	5	W
Storage and Junction Temperature	T_{stg}, T_j	-40 to +150	$^\circ C$
Thermal Resistance (Junction-to-tab (max))	θ_{J-tab}	10	$^\circ C/W$
Thermal Resistance (Junction-to-ambient (max))	θ_{J-a}^*	70	$^\circ C/W$

* Obtained with tabs soldered to printed circuit with minimized copper area.

ELECTRICAL CHARACTERISTICS (Ta = 25°C)

Parameter	Symbol	Test Condition	min	typ	max	Unit	
Supply Voltage (pin 1)	V _{CC}	V _{CC} = 14.4V	4	—	20	V	
Quiescent Output Voltage (pin 12)	V _{out}		6.4	7.2	8.0	V	
Quiescent Total Current Drain	I _T		—	12	20	mA	
Bias Current (pin 8)	I _b		—	0.4	—	μA	
Output Power	P _{out}	T.H.D = 10% R _L = 4Ω f = 1kHz	V _{CC} = 16V	—	7	—	W
			V _{CC} = 14.4V	—	6	—	
			V _{CC} = 12V	3.6	4.2	—	
			V _{CC} = 9V	—	2.5	—	
			V _{CC} = 6V	—	1	—	
Input Voltage	V _{in}		—	—	220	mVrms	
Input Sensitivity	V _i	P _{out} = 6W, V _{CC} = 14.4V R _L = 4Ω, f = 1kHz	R _f = 56Ω	—	80	—	mV
			R _f = 22Ω	—	35	—	
Input Resistance (pin 8)	R _{in}		—	5	—	MΩ	
Frequency Response (-3dB)	B	V _{CC} = 14.4V, R _L = 4Ω, R _f = 33Ω, C ₃ = 1000pF 1)	50 to 10,000			Hz	
Total Harmonic Distortion	T.H.D	P _{out} = 0.5W, V _{CC} = 14.4V, R _L = 4Ω, f = 1kHz	—	0.3	—	%	
Voltage Gain (open loop)	G _v	V _{CC} = 14.4V, R _L = 4Ω, f = 1kHz	—	80	—	dB	
Voltage Gain (closed loop)	G _v	V _{CC} = 14.4V, R _L = 4Ω, f = 1kHz	38.7	41.7	44.7	dB	
Input Noise Voltage	e _n	V _{CC} = 14.4V, R _g = 0 2)	—	1.2	—	μV	
Output Noise Voltage		V _{CC} = 15.0V, R _g = 7.7kΩ 3)	—	200	1,000	μV	
Efficiency	η	P _{out} = 5W, V _{CC} = 14.4V, R _L = 4Ω, f = 1kHz	—	70	—	%	
Hum Rejection	HR	V _{CC} = 14.4V, R _L = 4Ω, f = 100Hz	—	46	—	dB	

Notes: 1. When C₃ = 820pF, C₁ = 500μF, R_f = 56Ω, B = 40 to 20,000Hz

2. B (-3dB) of IC: 40 to 20,000 Hz, B (-3dB) of Test equipment: 20 to 20,000Hz

3. B (-3dB) of IC: 50 to 10,000Hz, B (-3dB) of Test equipment: 10 to 100,000Hz, 10kΩ is additionally connected at input terminals.

TEST CIRCUIT

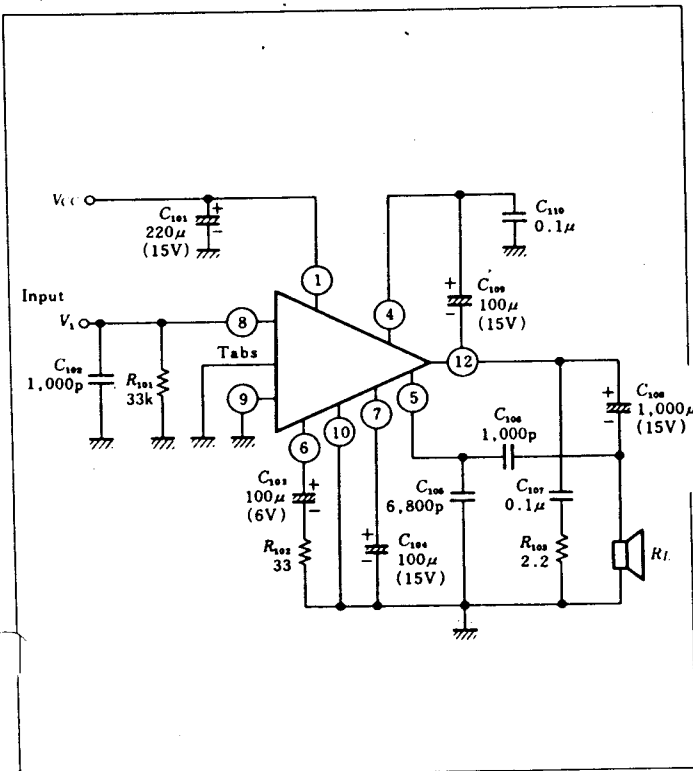

MOUNTING INSTRUCTIONS

The tabs on the TBA810 can be used to detract the heat generated in the integrated circuit so that the junction temperature does not exceed the permissible maximum (150°C).

This may be done by connecting tabs to an external heat sink, or by soldering them to a suitable copper area of the printed circuit board.

External heat sink or printed circuit copper area must be connected to electrical ground.

POWER RATING CHARACTERISTICS

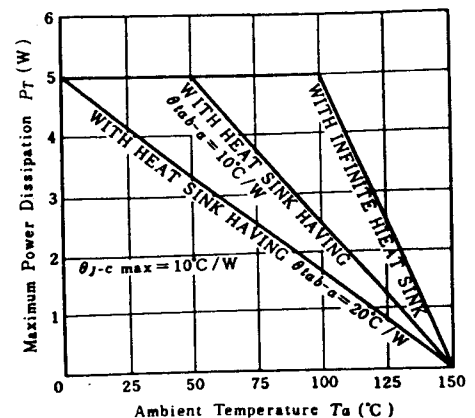

MAXIMUM POWER DISSIPATION VS. COPPER AREA OF P.C. BOARD

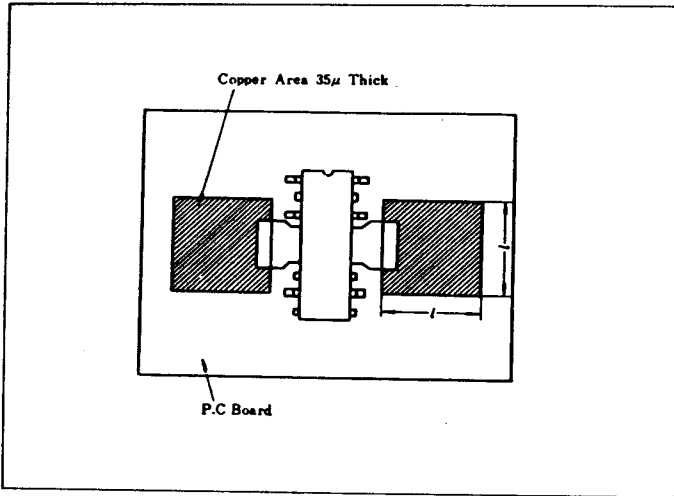

OUTPUT POWER VS. SUPPLY VOLTAGE

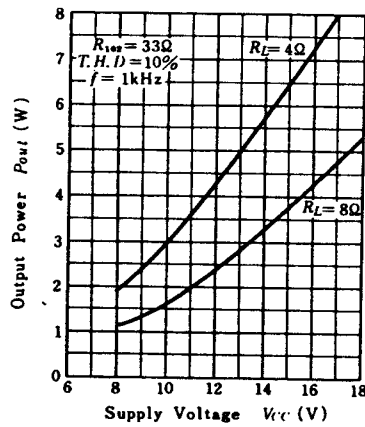

MAXIMUM POWER DISSIPATION VS. SUPPLY VOLTAGE

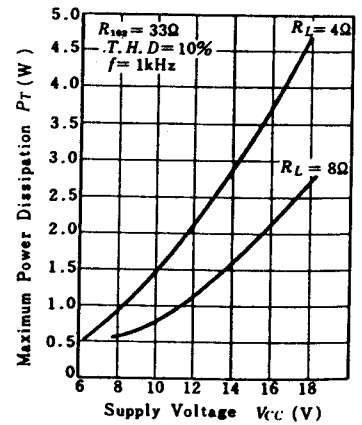

TOTAL HARMONIC DISTORTION VS. OUTPUT POWER

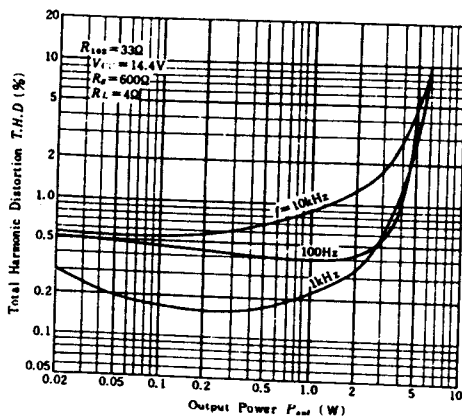

TOTAL HARMONIC DISTORTION VS. FREQUENCY

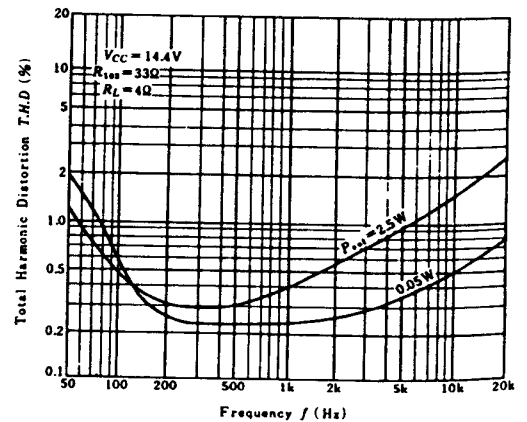

RELATIVE VOLTAGE GAIN AND INPUT VOLTAGE VS. FEEDBACK RESISTANCE

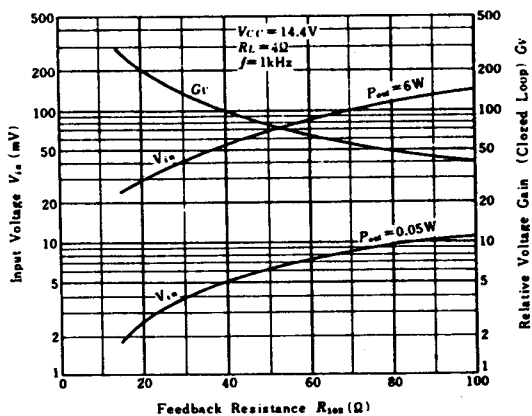

VALUE OF C106 VS. R102 FOR VARIOUS VALUE OF B

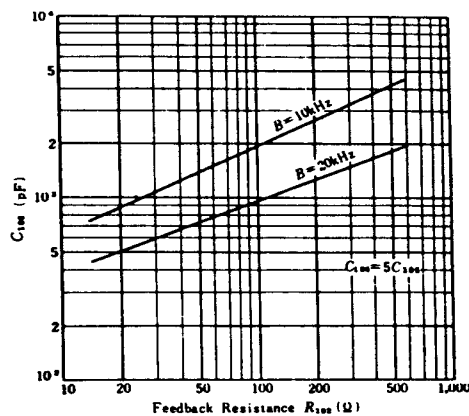

QUIESCENT TOTAL CURRENT DRAIN VS. SUPPLY VOLTAGE

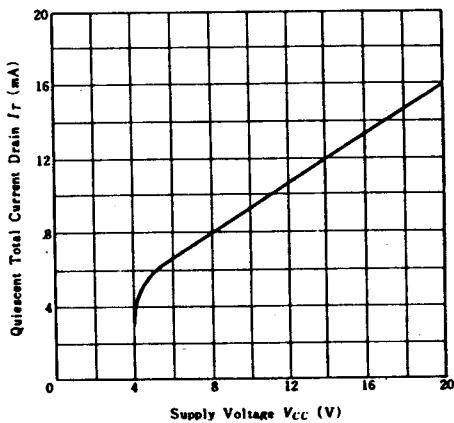

TYPICAL SUPPLY VOLTAGE REJECTION VS. FEEDBACK RESISTANCE

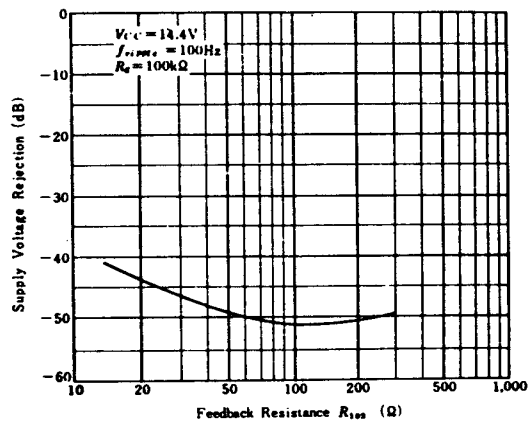

SUPPLY VOLTAGE REJECTION VS. RIPPLE FREQUENCY

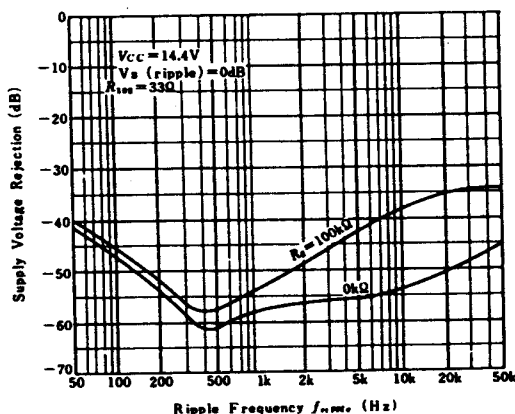

POWER BANDWIDTH CHARACTERISTICS

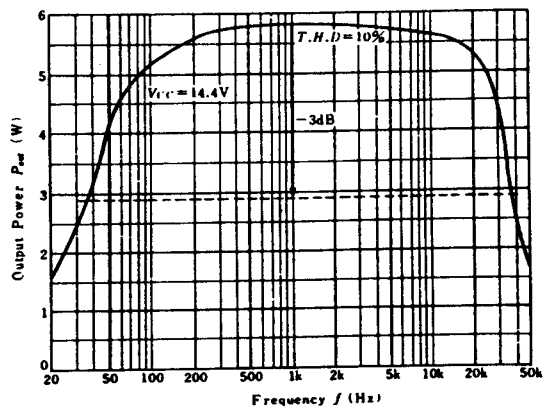

EXTERNAL COMPONENTS

Parts No.	Recommended Value	Purpose	Influence		Remarks
			Larger than recommended Value	Smaller than recommended Value	
R ₁₀₁	33kΩ	Determination of Input impedance	—	—	—
R ₁₀₂	33Ω	Determination of G _v	All Characteristics are influenced	Oscillation	$G_v = \frac{4000}{R_{102} (\Omega)}$
R ₁₀₃	2.2Ω (When C ₁₀₇ = 0.1μF)	Prevention of Oscillation	Oscillation	Oscillation	—
C ₁₀₃	100μF (When R ₁₀₂ = 33Ω)	Feedback Capacitor	f _L decreases	f _L increases	$f_L = \frac{1}{2\pi C_{103} R_{102}}$ (Low cut-off frequency)
C ₁₀₅ C ₁₀₆ C ₁₀₇ C ₁₁₀	6,800pF 1,000pF 0.1μF 0.1μF	Prevention of Oscillation	Oscillation	Oscillation	—
C ₁₀₈	1,000μF	Output Coupling Capacitor	Breakdown at Overload	Poor low-frequency characteristics	$f_L = \frac{1}{2\pi C_{108} R_L}$

The following figure illustrates a method of mounting the TBA810 that is satisfactory both from the heat dissipation viewpoint and from mechanical consideration.

