

# TDA8944J

2 x 7 W stereo Bridge Tied Load (BTL) audio amplifier

Rev. 02 — 14 February 2000

Product specification

## 1. General description

The TDA8944J is a dual-channel audio power amplifier with an output power of  $2 \times 7$  W at an  $8 \Omega$  load and a 12 V supply. The circuit contains two Bridge Tied Load (BTL) amplifiers with an all-NPN output stage and standby/mute logic. The TDA8944J comes in a 17-pin DIL-bent-SIL (DBS) power package. The TDA8944J is printed-circuit board (PCB) compatible with all other types in the TDA894x family. One PCB footprint accommodates both the mono and the stereo products.

## 2. Features

- Few external components
- Fixed gain
- Standby and mute mode
- No on/off switching plops
- Low standby current
- High supply voltage ripple rejection
- Outputs short-circuit protected to ground, supply and across the load
- Thermally protected
- Printed-circuit board compatible.

## 3. Applications

- Mains fed applications (e.g. TV sound)
- PC audio
- Portable audio.

## 4. Quick reference data

Table 1: Quick reference data

Symbol	Parameter	Conditions	Min	Typ	Max	Unit
$V_{CC}$	supply voltage		6	12	18	V
$I_q$	quiescent supply current	$V_{CC} = 12$ V; $R_L = \infty$	-	24	36	mA
$I_{stb}$	standby supply current		-	-	10	$\mu$ A



PHILIPS

Table 1: Quick reference data...continued

Symbol	Parameter	Conditions	Min	Typ	Max	Unit
$P_o$	output power	THD = 10%; $R_L = 8 \Omega$ ; $V_{CC} = 12 V$	6	7	-	W
THD	total harmonic distortion	$P_o = 1 W$	-	0.03	0.1	%
$G_v$	voltage gain		31	32	33	dB
SVRR	supply voltage ripple rejection		50	65	-	dB

### 5. Ordering information

Table 2: Ordering information

Type number	Package		Version
	Name	Description	
TDA8944J	DBS17P	plastic DIL-bent-SIL power package; 17 leads (lead length 12 mm)	SOT243-1

### 6. Block diagram

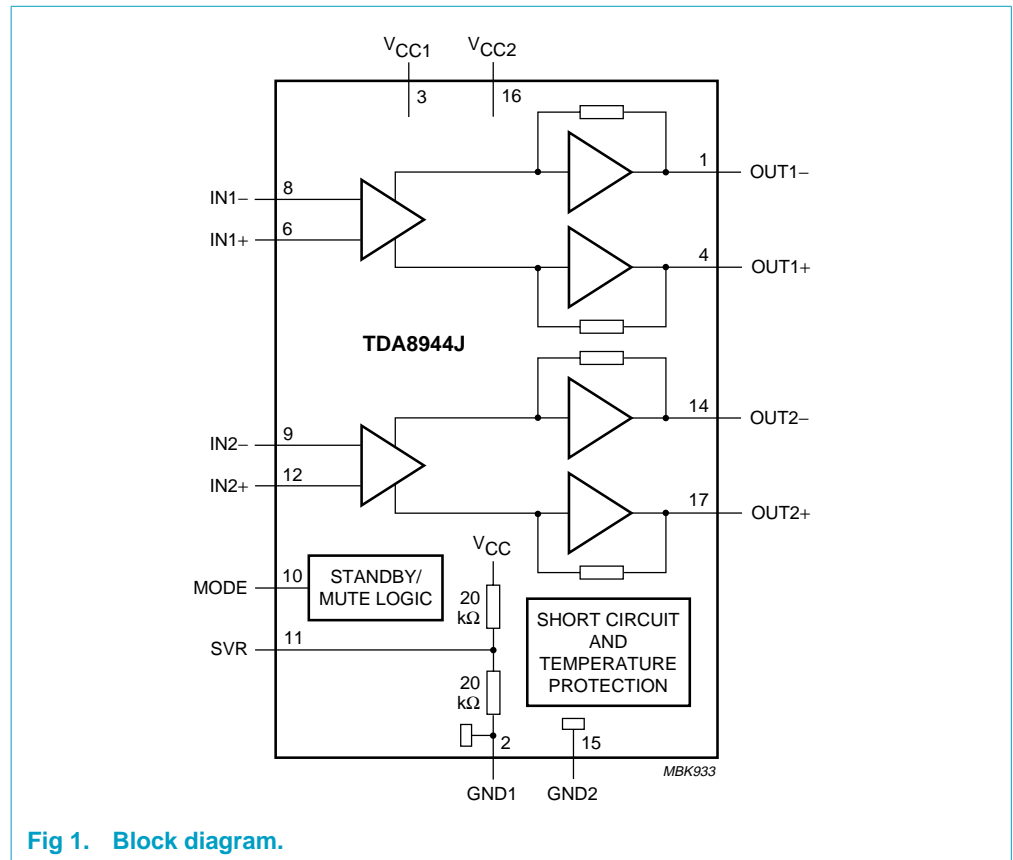

Fig 1. Block diagram.

## 7. Pinning information

### 7.1 Pinning

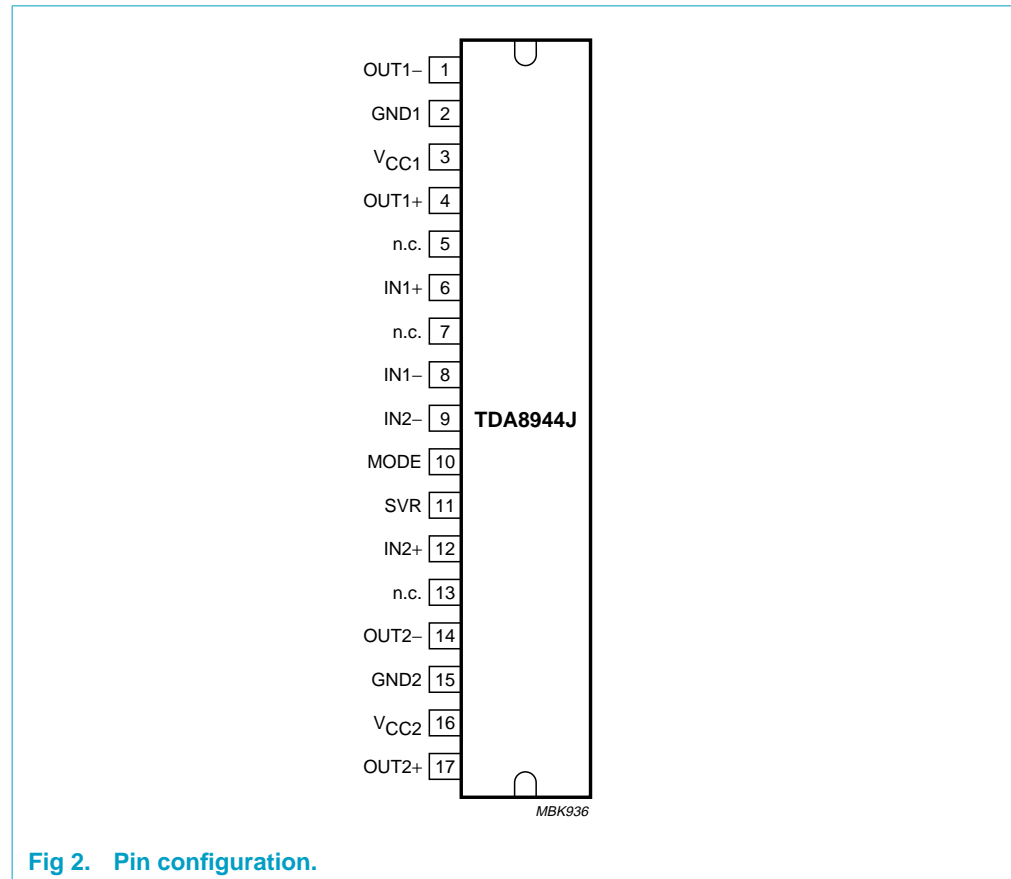

Fig 2. Pin configuration.

### 7.2 Pin description

Table 3: Pin description

Symbol	Pin	Description
OUT1-	1	negative loudspeaker terminal 1
GND1	2	ground channel 1
V <sub>CC1</sub>	3	supply voltage channel 1
OUT1+	4	positive loudspeaker terminal 1
n.c.	5	not connected
IN1+	6	positive input 1
n.c.	7	not connected
IN1-	8	negative input 1
IN2-	9	negative input 2
MODE	10	mode selection input (standby, mute, operating)
SVR	11	half supply voltage decoupling (ripple rejection)
IN2+	12	positive input 2

Table 3: Pin description...continued

Symbol	Pin	Description
n.c.	13	not connected
OUT2-	14	negative loudspeaker terminal 2
GND2	15	ground channel 2
V <sub>CC2</sub>	16	supply voltage channel 2
OUT2+	17	positive loudspeaker terminal 2

## 8. Functional description

The TDA8944J is a stereo BTL audio power amplifier capable of delivering 2 × 7 W output power to an 8 Ω load at THD = 10%, using a 12 V power supply and an external heatsink. The voltage gain is fixed at 32 dB.

With the three-level MODE input the device can be switched from 'standby' to 'mute' and to 'operating' mode.

The TDA8944J outputs are protected by an internal thermal shutdown protection mechanism and a short-circuit protection.

### 8.1 Input configuration

The TDA8944J inputs can be driven symmetrical (floating) as well as asymmetrical. In the asymmetrical mode one input pin is connected via a capacitor to the signal ground which should be as close as possible to the SVR (electrolytic) capacitor ground. Note that the DC level of the input pins is half of the supply voltage V<sub>CC</sub>, so coupling capacitors for both pins are necessary.

The input cut-off frequency is:

$$f_{i(cut-off)} = \frac{1}{2 - (R_i \times C_i)} \quad (1)$$

For R<sub>i</sub> = 45 kΩ and C<sub>i</sub> = 220 nF:

$$f_{i(cut-off)} = \frac{1}{2 - (45 \times 10^3 \times 220 \times 10^{-9})} = 16 \text{ Hz} \quad (2)$$

As shown in [Equation 1](#) and [2](#), large capacitor values for the inputs are not necessary; so the switch-on delay during charging of the input capacitors, can be minimized. This results in a good low frequency response and good switch-on behaviour.

**Remark:** To prevent HF oscillations do not leave the inputs open, connect a capacitor of at least 1.5 nF across the input pins close to the device.

## 8.2 Power amplifier

The power amplifier is a Bridge Tied Load (BTL) amplifier with an all-NPN output stage, capable of delivering a peak output current of 2 A.

The BTL principle offers the following advantages:

- Lower peak value of the supply current
- The ripple frequency on the supply voltage is twice the signal frequency
- No expensive DC-blocking capacitor
- Good low frequency performance.

### 8.2.1 Output power measurement

The output power as a function of the supply voltage is measured on the output pins at THD = 10%; see [Figure 8](#). The maximum output power is limited by the maximum supply voltage of 12 V and the maximum available output current: 2 A repetitive peak current.

### 8.2.2 Headroom

Typical CD music requires at least 12 dB (factor 15.85) dynamic headroom – compared to the average power output – for transferring the loudest parts without distortion. At  $V_{CC} = 12\text{ V}$ ,  $R_L = 8\ \Omega$  and  $P_o = 4\text{ W}$  at THD = 0.1% (see [Figure 6](#)), the Average Listening Level (ALL) – music power – without any distortion yields:

$$P_{o(ALL)} = 4\text{ W}/15.85 = 252\text{ mW}.$$

The power dissipation can be derived from [Figure 11 on page 10](#) for 0 dB respectively 12 dB headroom.

**Table 4: Power rating as function of headroom**

Headroom	Power output (THD = 0.1%)	Power dissipation (P)
0 dB	$P_o = 4\text{ W}$	8 W
12 dB	$P_{o(ALL)} = 252\text{ mW}$	4 W

For the average listening level a power dissipation of 4 W can be used for a heatsink calculation.

## 8.3 Mode selection

The TDA8944J has three functional modes, which can be selected by applying the proper DC voltage to pin MODE. See [Figure 4](#) and [5](#) for the respective DC levels, which depend on the supply voltage level. The MODE pin can be driven by a 3-state logic output stage: e.g. a microcontroller with additional components for DC-level shifting.

**Standby** — In this mode the current consumption is very low and the outputs are floating. The device is in standby mode when  $(V_{CC} - 0.5\text{ V}) < V_{MODE} < V_{CC}$ , or when the MODE pin is left floating (high impedance). The power consumption of the TDA8944J will be reduced to <0.18 mW.

**Mute** — In this mode the amplifier is DC-biased but not operational (no audio output); the DC level of the input and output pins remain on half the supply voltage. This allows the input coupling and Supply Voltage Ripple Rejection (SVRR) capacitors to be charged to avoid pop-noise. The device is in mute mode when  $3\text{ V} < V_{\text{MODE}} < (V_{\text{CC}} - 1.5\text{ V})$ .

**Operating** — In this mode the amplifier is operating normally. The operating mode is activated at  $V_{\text{MODE}} < 0.5\text{ V}$ .

### 8.3.1 Switch-on and switch-off

To avoid audible plops during supply voltage switch-on or switch-off, the device is set to standby mode before the supply voltage is applied (switch-on) or removed (switch-off).

The switch-on and switch-off time can be influenced by an RC-circuit on the MODE pin. Rapid on/off switching of the device or the MODE pin may cause 'click- and pop-noise'. This can be prevented by proper timing of the RC-circuit on the MODE pin.

## 8.4 Supply Voltage Ripple Rejection (SVRR)

The SVRR is measured with an electrolytic capacitor of  $10\text{ }\mu\text{F}$  on pin SVR at a bandwidth of 10 Hz to 80 kHz. [Figure 13 on page 11](#) illustrates the SVRR as function of the frequency. A larger capacitor value on the SVR pin improves the ripple rejection behaviour at the lower frequencies.

## 8.5 Built-in protection circuits

The TDA8944J contains two types of protection circuits, i.e. short-circuit and thermal shutdown.

### 8.5.1 Short-circuit protection

**Short-circuit to ground or supply line** — This is detected by a so-called 'missing current' detection circuit which measures the current in the positive supply line and the current in the ground line. A difference between both currents larger than 0.4 A, switches the power stage to standby mode (high impedance).

**Short-circuit across the load** — This is detected by an absolute-current measurement. An absolute-current larger than 2 A, switches the power stage to standby mode (high impedance).

### 8.5.2 Thermal shutdown protection

The junction temperature is measured by a temperature sensor; at a junction temperature of approximately  $150\text{ }^{\circ}\text{C}$  this detection circuit switches the power stage to standby mode (high impedance).

## 9. Limiting values

**Table 5: Limiting values**

In accordance with the Absolute Maximum Rating System (IEC 60134).

Symbol	Parameter	Conditions	Min	Max	Unit
V <sub>CC</sub>	supply voltage	no signal	-0.3	+25	V
		operating	-0.3	+18	V
V <sub>I</sub>	input voltage		-0.3	V <sub>CC</sub> + 0.3	V
I <sub>ORM</sub>	repetitive peak output current		-	2	A
T <sub>stg</sub>	storage temperature	non-operating	-55	+150	°C
T <sub>amb</sub>	operating ambient temperature		-40	+85	°C
P <sub>tot</sub>	total power dissipation		-	18	W
V <sub>CC(sc)</sub>	supply voltage to guarantee short-circuit protection		-	15	V

## 10. Thermal characteristics

**Table 6: Thermal characteristics**

Symbol	Parameter	Conditions	Value	Unit
R <sub>th(j-a)</sub>	thermal resistance from junction to ambient	in free air	40	K/W
R <sub>th(j-mb)</sub>	thermal resistance from junction to mounting base	both channels driven	6.9	K/W

## 11. Static characteristics

**Table 7: Static characteristics**

V<sub>CC</sub> = 12 V; T<sub>amb</sub> = 25 °C; R<sub>L</sub> = 8 Ω; V<sub>MODE</sub> = 0 V; V<sub>I</sub> = 0 V; measured in test circuit [Figure 14](#); unless otherwise specified.

Symbol	Parameter	Conditions	Min	Typ	Max	Unit
V <sub>CC</sub>	supply voltage	operating	6	12	18	V
I <sub>q</sub>	quiescent supply current	R <sub>L</sub> = ∞	[1] -	24	36	mA
I <sub>stb</sub>	standby supply current	V <sub>MODE</sub> = V <sub>CC</sub>	-	-	10	μA
V <sub>O</sub>	DC output voltage	[2] -	-	6	-	V
ΔV <sub>OUT</sub> [3]	differential output voltage offset		-	-	200	mV
V <sub>MODE</sub>	mode selection input voltage	operating mode	0	-	0.5	V
		mute mode	3	-	V <sub>CC</sub> - 1.5	V
		standby mode	V <sub>CC</sub> - 0.5	-	V <sub>CC</sub>	V
I <sub>MODE</sub>	mode selection input current	0 < V <sub>MODE</sub> < V <sub>CC</sub>	-	-	20	μA

[1] With a load connected at the outputs the quiescent current will increase, the maximum of this increase being equal to the differential output voltage offset (ΔV<sub>OUT</sub>) divided by the load resistance (R<sub>L</sub>).

[2] The DC output voltage with respect to ground is approximately 0.5V<sub>CC</sub>.

[3] ΔV<sub>OUT</sub> = |V<sub>OUT+</sub> - V<sub>OUT-</sub>|

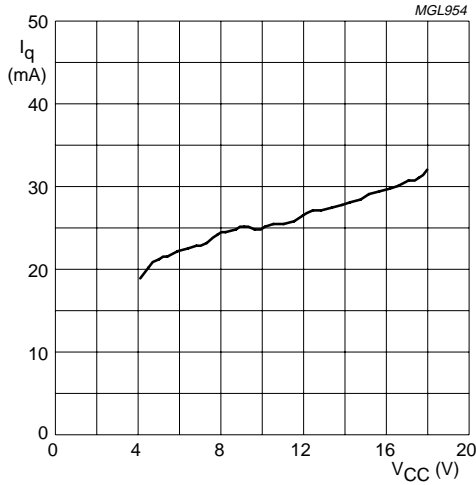

Fig 3. Quiescent current as function of supply voltage.

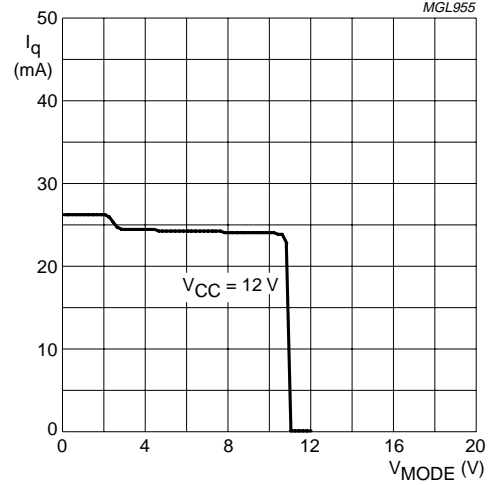

Fig 4. Quiescent current as function of mode voltage.

## 12. Dynamic characteristics

Table 8: Dynamic characteristics

$V_{CC} = 12\text{ V}$ ;  $T_{amb} = 25\text{ }^\circ\text{C}$ ;  $R_L = 8\ \Omega$ ;  $f = 1\text{ kHz}$ ;  $V_{MODE} = 0\text{ V}$ ; measured in test circuit [Figure 14](#); audio pass band 22 Hz to 22 kHz; unless otherwise specified.

Symbol	Parameter	Conditions	Min	Typ	Max	Unit
P <sub>o</sub>	output power	THD = 10%	6	7	-	W
		THD = 0.5%	4	5	-	W
THD	total harmonic distortion	P <sub>o</sub> = 1 W	-	0.03	0.1	%
G <sub>v</sub>	voltage gain		31	32	33	dB
Z <sub>i(dif)</sub>	differential input impedance		70	90	110	kΩ
V <sub>n(o)</sub>	noise output voltage		[1] -	90	120	μV
SVRR	supply voltage ripple rejection	f <sub>ripple</sub> = 1 kHz	[2] 50	65	-	dB
		f <sub>ripple</sub> = 100 Hz to 20 kHz	[2] -	60	-	dB
V <sub>o(mute)</sub>	output voltage	mute mode	[3] -	-	50	μV
α <sub>cs</sub>	channel separation	R <sub>s</sub> = 0 Ω	50	75	-	dB

- [1] The noise output voltage is measured at the output in a frequency range from 20 Hz to 20 kHz (unweighted), with a source impedance R<sub>s</sub> = 0 Ω at the input.
- [2] Supply voltage ripple rejection is measured at the output, with a source impedance R<sub>s</sub> = 0 Ω at the input. The ripple voltage is a sine wave with a frequency f<sub>ripple</sub> and an amplitude of 707 mV (RMS), which is applied to the positive supply rail.
- [3] Output voltage in mute mode is measured with an input voltage of 1 V (RMS) in a bandwidth of 20 kHz, so including noise.



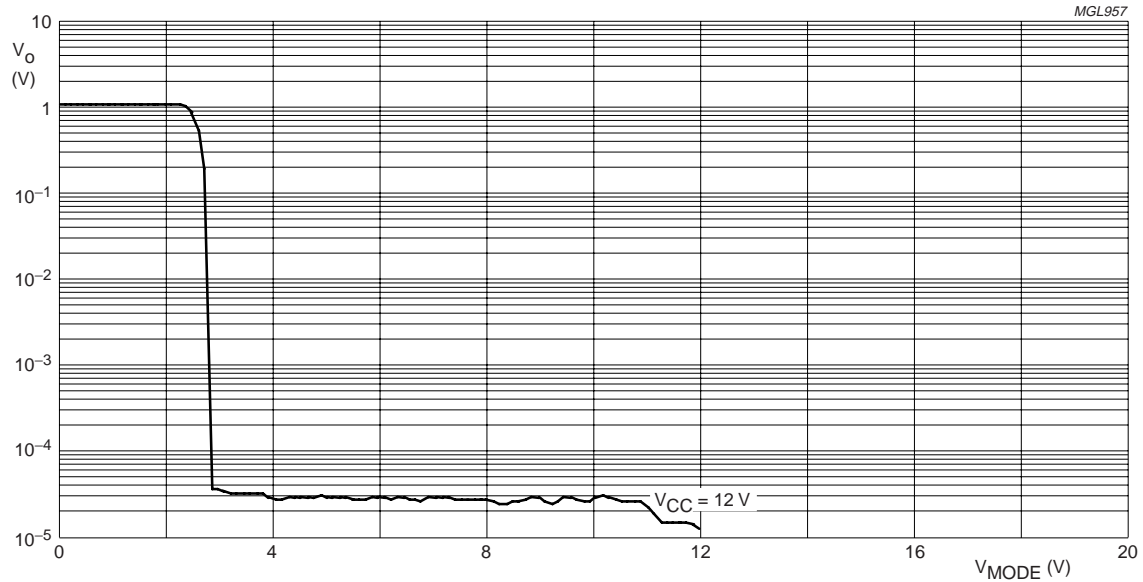

Fig 5. Output voltage as function of mode voltage.

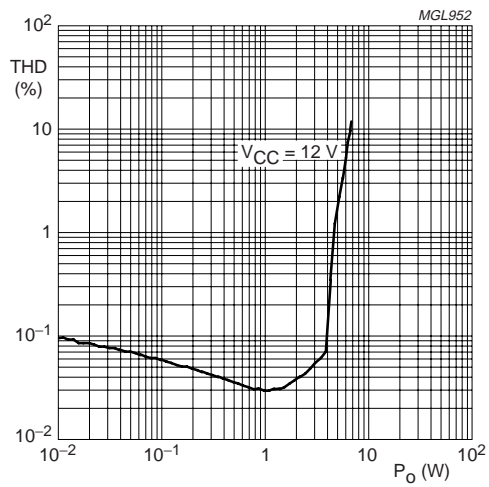
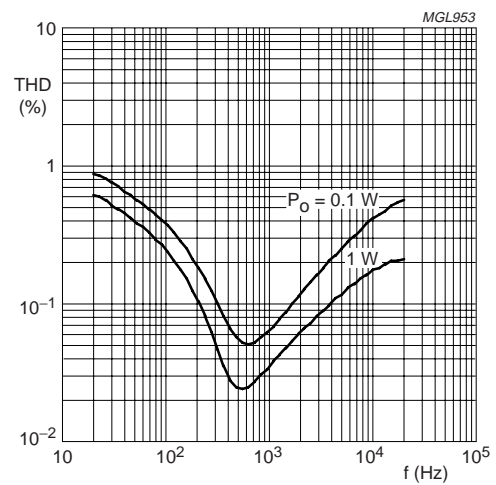
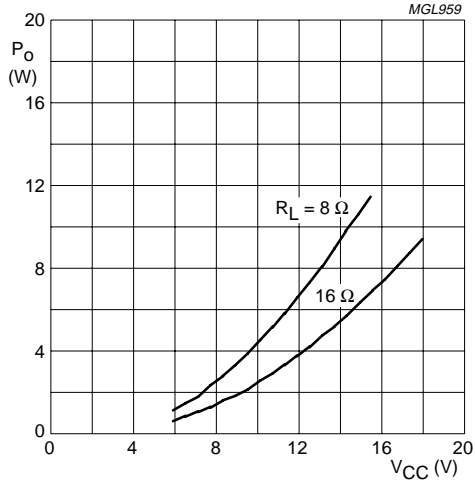

Fig 6. Total harmonic distortion as function of output power.



No bandpass filter applied.

Fig 7. Total harmonic distortion as function of frequency.



THD = 10%.

Fig 8. Output power as function of supply voltage.

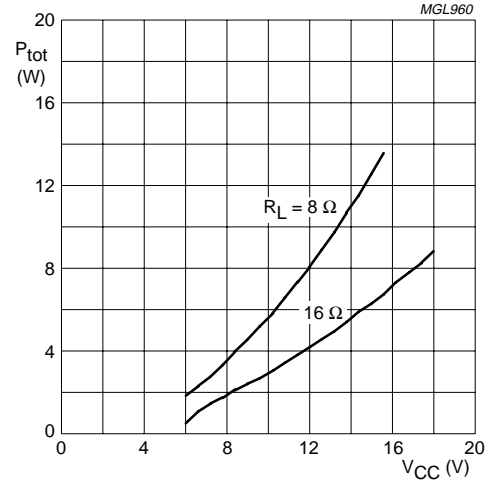
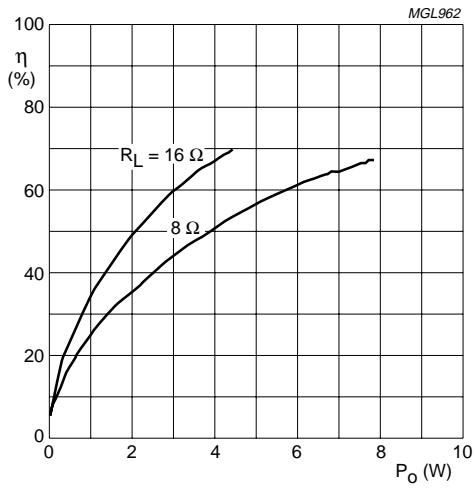

Fig 9. Total power dissipation as function of supply voltage.



$V_{CC} = 12\ V$ .

Fig 10. Efficiency as function of output power.

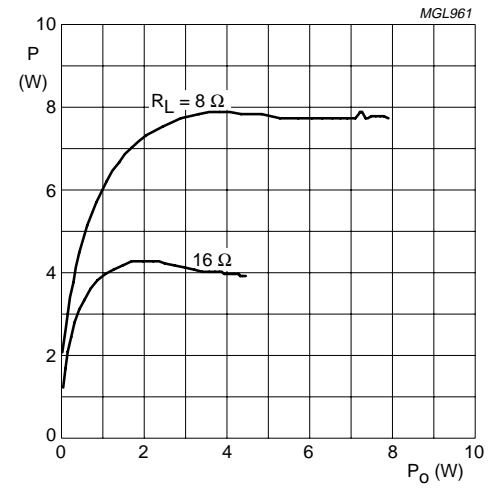
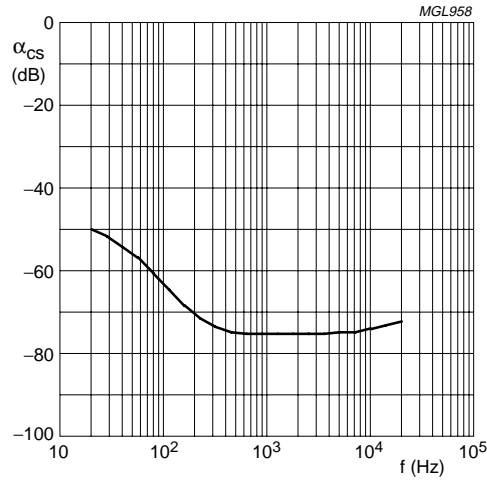
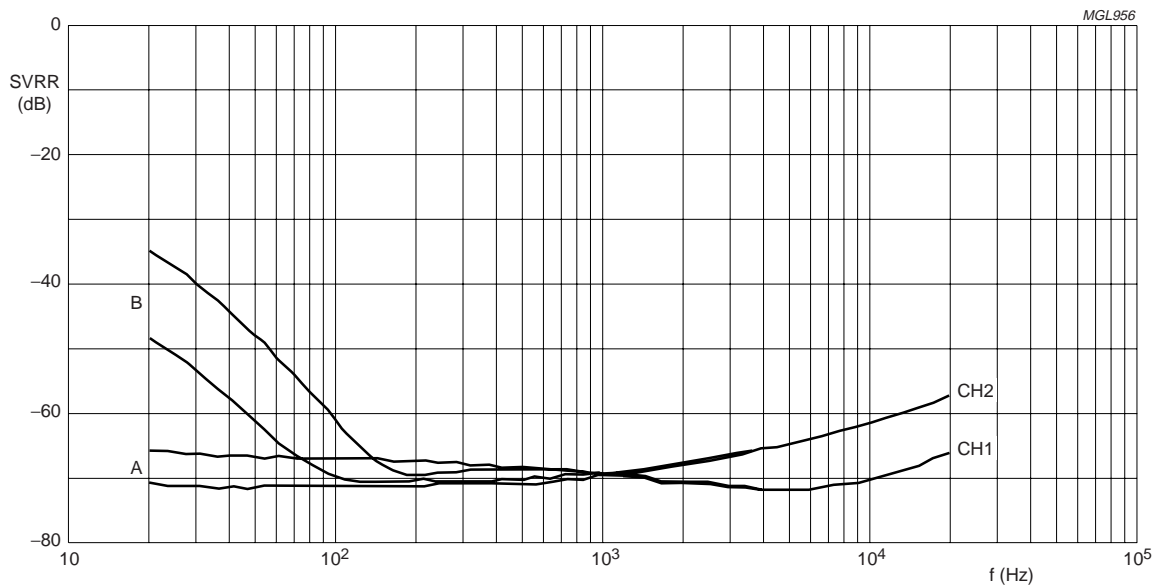

Fig 11. Power dissipation as function of output power.



No bandpass filter applied.

Fig 12. Channel separation as function of frequency.



$V_{CC} = 12\text{ V}$ ;  $R_s = 0\ \Omega$ ;  $V_{\text{ripple}} = 707\text{ mV}$  (peak-to-peak); no bandpass filter applied.

Curves A: inputs short-circuited

Curves B: inputs short-circuited and connected to ground (asymmetrical application)

Fig 13. Supply voltage ripple rejection as function of frequency.

13. Internal circuitry

Table 9: Internal circuitry

Pin	Symbol	Equivalent circuit
6 and 8	IN1+ and IN1-	<p>MGL946</p>
12 and 9	IN2+ and IN2-	
1 and 4	OUT1- and OUT1+	<p>MGL947</p>
14 and 17	OUT2- and OUT2+	
10	MODE	<p>MGL949</p>
11	SVR	<p>MGL948</p>

14. Application information

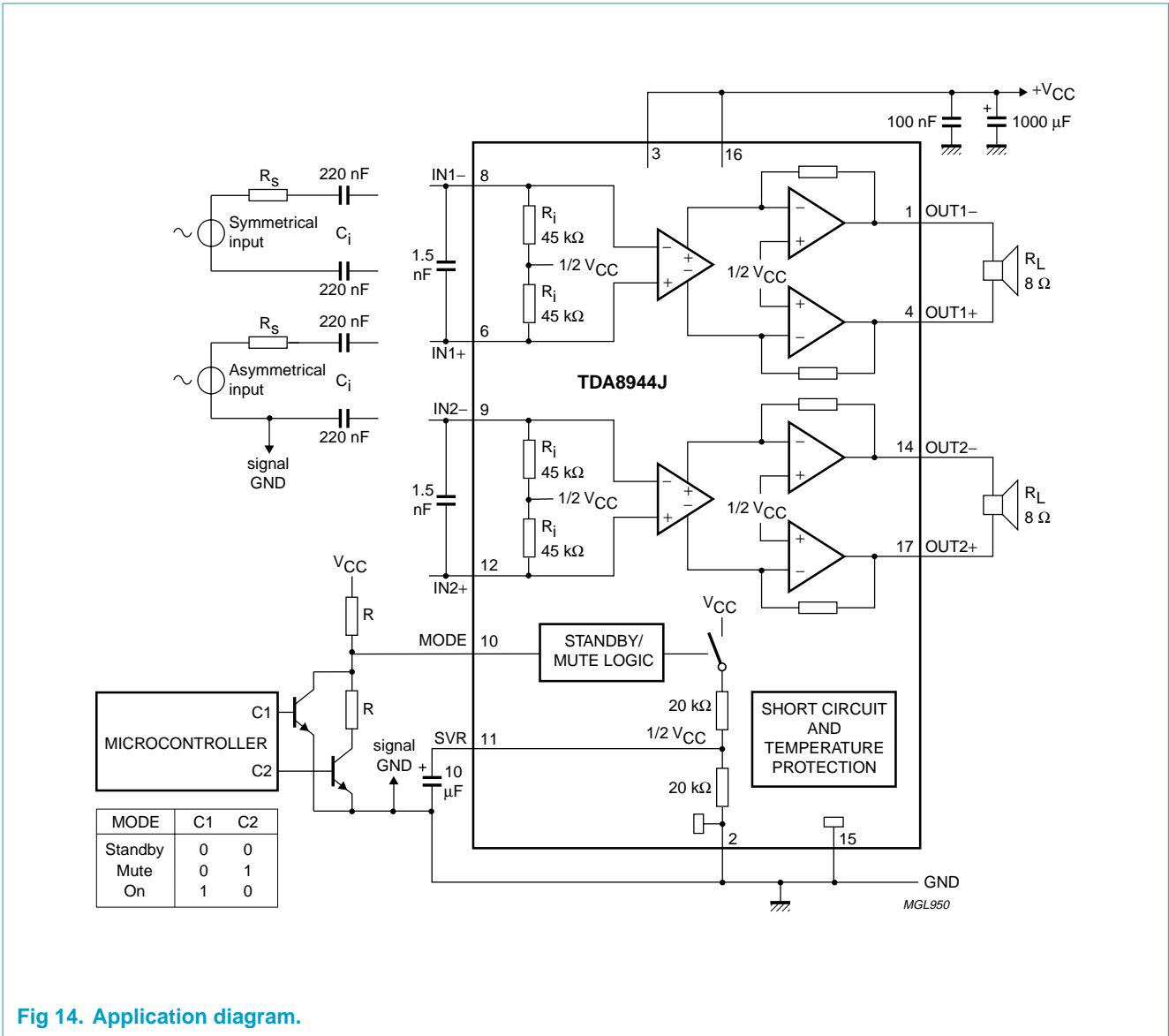

Fig 14. Application diagram.

14.1 Printed-circuit board (PCB)

14.1.1 Layout and grounding

For a high system performance level certain grounding techniques are essential. The input reference grounds have to be tied with their respective source grounds and must have separate tracks from the power ground tracks; this will prevent the large (output) signal currents from interfering with the small AC input signals. The small-signal ground tracks should be physically located as far as possible from the power ground tracks. Supply and output tracks should be as wide as possible for delivering maximum output power.

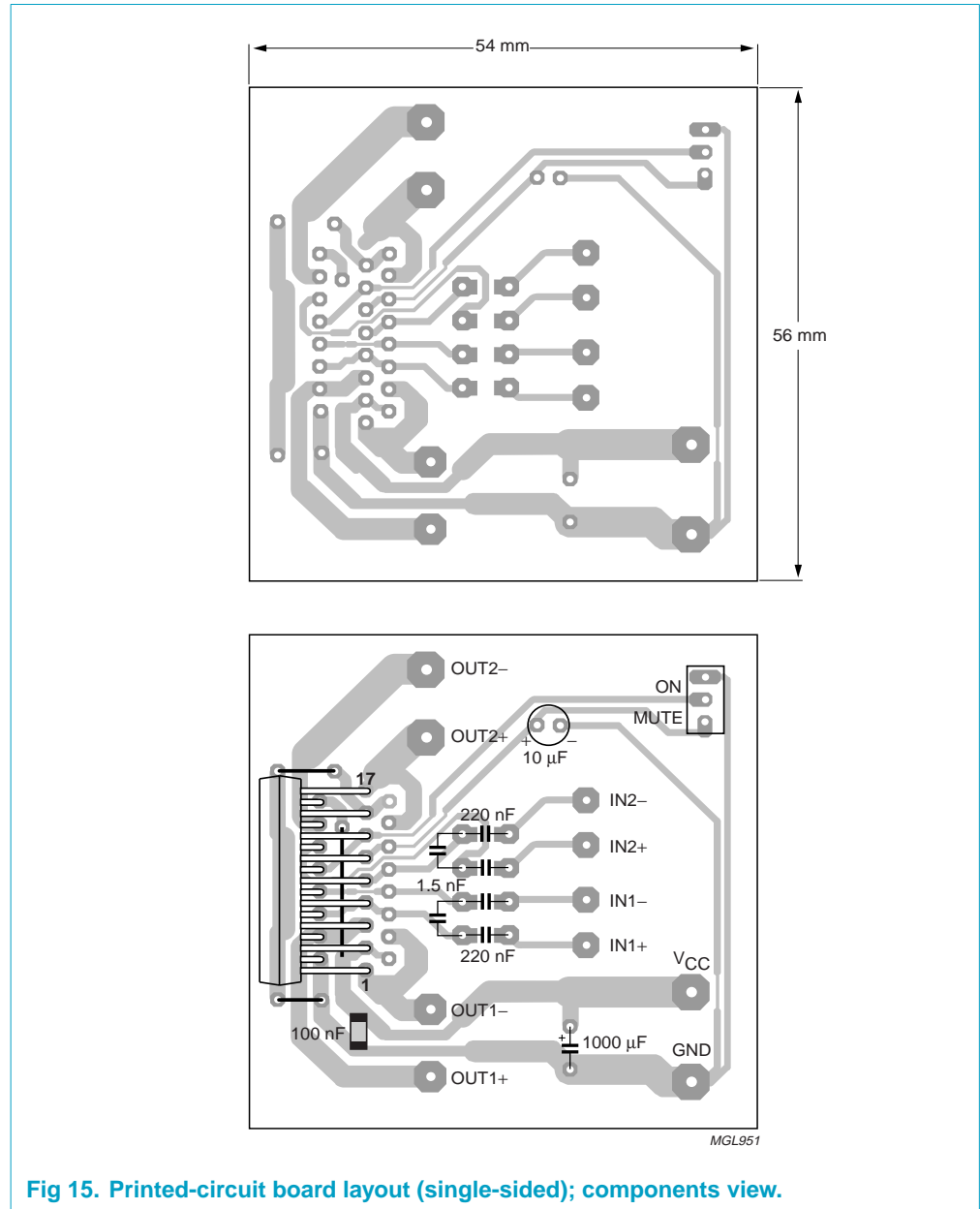

Fig 15. Printed-circuit board layout (single-sided); components view.

14.1.2 Power supply decoupling

Proper supply bypassing is critical for low-noise performance and high supply voltage ripple rejection. The respective capacitor locations should be as close as possible to the device and grounded to the power ground. Proper power supply decoupling also prevents oscillations.

For suppressing higher frequency transients (spikes) on the supply line a capacitor with low ESR – typical 100 nF – has to be placed as close as possible to the device. For suppressing lower frequency noise and ripple signals, a large electrolytic capacitor – e.g. 1000 μF or greater – must be placed close to the device.

The bypass capacitor on the SVR pin reduces the noise and ripple on the midrail voltage. For good THD and noise performance a low ESR capacitor is recommended.

## 14.2 Thermal behaviour and heatsink calculation

The measured maximum thermal resistance of the IC package,  $R_{th(j-mb)}$  is 6.9 K/W. A calculation for the heatsink can be made, with the following parameters:

$$T_{amb(max)} = 50 \text{ }^{\circ}\text{C}$$

$$V_{CC} = 12 \text{ V and } R_L = 8 \text{ } \Omega$$

$$T_{j(max)} = 150 \text{ }^{\circ}\text{C}.$$

$R_{th(tot)}$  is the total thermal resistance between the junction and the ambient including the heatsink. In the heatsink calculations the value of  $R_{th(mb-h)}$  is ignored.

At  $V_{CC} = 12 \text{ V}$  and  $R_L = 8 \text{ } \Omega$  the measured worstcase sine-wave dissipation is 8 W; see [Figure 11](#). For  $T_{j(max)} = 150 \text{ }^{\circ}\text{C}$  the temperature raise - caused by the power dissipation - is:  $150 - 50 = 100 \text{ }^{\circ}\text{C}$ .

$$P \times R_{th(tot)} = 100 \text{ }^{\circ}\text{C}$$

$$R_{th(tot)} = 100/8 = 12.5 \text{ K/W}$$

$$R_{th(h-a)} = R_{th(tot)} - R_{th(j-mb)} = 12.5 - 6.9 = 5.6 \text{ K/W}.$$

The calculation above is for an application at worstcase (stereo) sine-wave output signals. In practice music signals will be applied, which decreases the maximum power dissipation to approximately half of the sine-wave power dissipation (see [Section 8.2.2](#)). This allows for the use of a smaller heatsink:

$$P \times R_{th(tot)} = 100 \text{ }^{\circ}\text{C}$$

$$R_{th(tot)} = 100/4 = 25 \text{ K/W}$$

$$R_{th(h-a)} = R_{th(tot)} - R_{th(j-mb)} = 25 - 6.9 = 18.1 \text{ K/W}.$$

To increase the lifetime of the IC,  $T_{j(max)}$  should be reduced to 125  $^{\circ}\text{C}$ . This requires a heatsink of approximately 12 K/W for music signals.

## 15. Test information

### 15.1 Quality information

The *General Quality Specification for Integrated Circuits, SNW-FQ-611D* is applicable.

### 15.2 Test conditions

$T_{amb} = 25 \text{ }^{\circ}\text{C}$ ;  $V_{CC} = 12 \text{ V}$ ;  $f = 1 \text{ kHz}$ ;  $R_L = 8 \text{ } \Omega$ ; audio pass band 22 Hz to 22 kHz; unless otherwise specified.

**Remark:** In the graphs as function of frequency no bandpass filter was applied; see [Figure 7](#), [12](#) and [13](#).

16. Package outline

DBS17P: plastic DIL-bent-SIL power package; 17 leads (lead length 12 mm)

SOT243-1

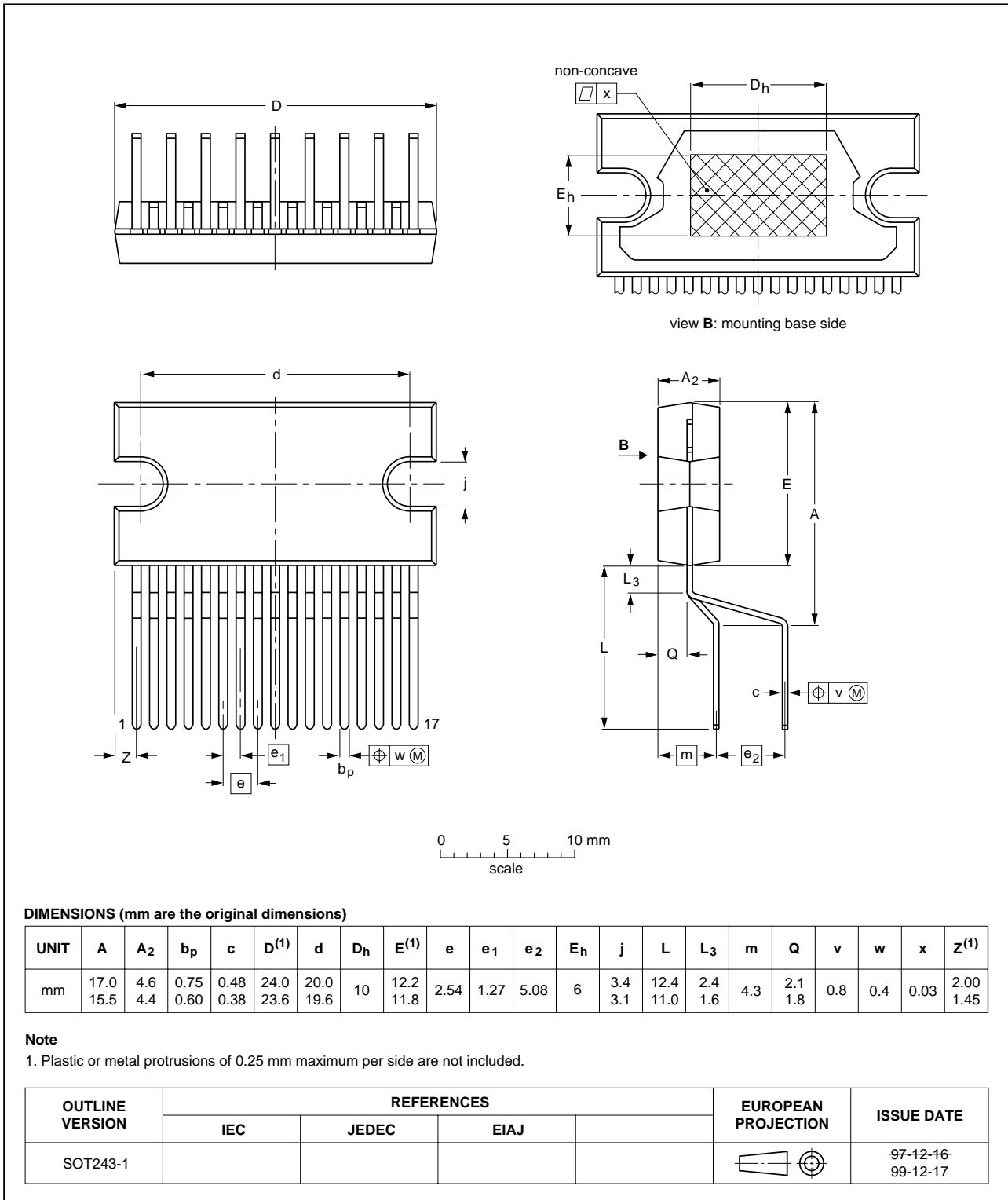

Fig 16. DBS17P package outline.



## 17. Soldering

### 17.1 Introduction to soldering through-hole mount packages

This text gives a brief insight to wave, dip and manual soldering. A more in-depth account of soldering ICs can be found in our *Data Handbook IC26; Integrated Circuit Packages* (document order number 9398 652 90011).

Wave soldering is the preferred method for mounting of through-hole mount IC packages on a printed-circuit board.

### 17.2 Soldering by dipping or by solder wave

The maximum permissible temperature of the solder is 260 °C; solder at this temperature must not be in contact with the joints for more than 5 seconds. The total contact time of successive solder waves must not exceed 5 seconds.

The device may be mounted up to the seating plane, but the temperature of the plastic body must not exceed the specified maximum storage temperature ( $T_{stg(max)}$ ). If the printed-circuit board has been pre-heated, forced cooling may be necessary immediately after soldering to keep the temperature within the permissible limit.

### 17.3 Manual soldering

Apply the soldering iron (24 V or less) to the lead(s) of the package, either below the seating plane or not more than 2 mm above it. If the temperature of the soldering iron bit is less than 300 °C it may remain in contact for up to 10 seconds. If the bit temperature is between 300 and 400 °C, contact may be up to 5 seconds.

### 17.4 Package related soldering information

**Table 10: Suitability of through-hole mount IC packages for dipping and wave soldering methods**

Package	Soldering method	
	Dipping	Wave
DBS, DIP, HDIP, SDIP, SIL	suitable	suitable <sup>[1]</sup>

[1] For SDIP packages, the longitudinal axis must be parallel to the transport direction of the printed-circuit board.

## 18. Revision history

Table 11: Revision history

Rev	Date	CPCN	Description
02	000214	-	<p><b>Product specification; second version; supersedes initial version TDA8944J-01 of 14 April 1999 (9397 750 04881). Modifications:</b></p> <ul style="list-style-type: none"> <li>• <b>Table 1 on page 1:</b> SVRR; Typ value 65 dB → added</li> <li>• <b>Figure 1 on page 2:</b> Block diagram; pin numbers changed OUT2- → 14 and OUT2+ → 17</li> <li>• <b>Figure 2 on page 3:</b> Pin configuration; pin numbers changed OUT2- → 14 and OUT2+ → 17</li> <li>• <b>Section 8 “Functional description”:</b> <ul style="list-style-type: none"> <li>– <b>Section 8.1 “Input configuration” on page 4</b> → added.</li> <li>– <b>Section 8.2 “Power amplifier” on page 5:</b> ....., capable of delivering a peak output current of 1.5 A → changed to 2 A.</li> <li>– <b>Section 8.2.1 “Output power measurement” on page 5</b> → added</li> <li>– <b>Section 8.2.2 “Headroom” on page 5</b> → added</li> </ul> </li> <li>• <b>Section 8.3 “Mode selection”:</b> <ul style="list-style-type: none"> <li>– Standby mode: <math>V_{\text{MODE}} &gt; (V_{\text{CC}} - 0.5 \text{ V})</math> → changed to <math>(V_{\text{CC}} - 0.5 \text{ V}) &lt; V_{\text{MODE}} &lt; V_{\text{CC}}</math>; The power consumption of the TDA8944J will be reduced to <math>&lt; 0.18 \text{ mW}</math> → added.</li> <li>– Mute mode: the DC level of the input and output pins remain on half the supply voltage → added;</li> <li>– <math>2.5 \text{ V} &lt; V_{\text{MODE}} &lt; (V_{\text{CC}} - 1.5 \text{ V})</math> → changed to <math>3 \text{ V} &lt; V_{\text{MODE}} &lt; (V_{\text{CC}} - 1.5 \text{ V})</math></li> <li>– <b>Section 8.3.1 “Switch-on and switch-off” on page 6</b></li> </ul> </li> <li>• <b>Section 8.4 “Supply Voltage Ripple Rejection (SVRR)” on page 6</b> → added</li> <li>• <b>Section 8.5 “Built-in protection circuits” on page 6</b> → added</li> <li>• <b>Table 5 on page 7:</b> <ul style="list-style-type: none"> <li>– <math>P_{\text{tot}}</math> value added 18 W</li> <li>– <math>V_{\text{CC}(\text{sc})}</math> value added 15 V</li> </ul> </li> <li>• <b>Table 6 on page 7:</b> <ul style="list-style-type: none"> <li>– <math>R_{\text{th}(\text{j-a})}</math> value added 40 K/W</li> <li>– <math>R_{\text{th}(\text{j-c})}</math> value 10 → changed to 6.9 K/W; condition ‘in free air’ → changed to ‘both channels driven’</li> </ul> </li> <li>• <b>Table 7 on page 7:</b> <math>V_{\text{MODE}}</math> - mute mode - value Min 2.5 → changed to 3 V</li> <li>• <b>Table 8 on page 8:</b> <ul style="list-style-type: none"> <li>– SVRR; Typ values 65 and 60 dB → added</li> <li>– <math>\alpha_{\text{CS}}</math>; Typ value 75 dB → added</li> </ul> </li> <li>• <b>Figure 3 to 13:</b> figures added</li> <li>• <b>Section 13 “Internal circuitry” on page 12:</b> → added</li> <li>• <b>Figure 14:</b> figure adjusted</li> <li>• <b>Section 14.1 “Printed-circuit board (PCB)” on page 13:</b> → added</li> <li>• <b>Figure 15:</b> figure added</li> <li>• <b>Section 14.2 “Thermal behaviour and heatsink calculation” on page 15:</b> → added</li> <li>• <b>Section 15.2 “Test conditions” on page 15:</b> → added</li> </ul>
01	990414	-	<b>Preliminary specification; initial version.</b>

## 19. Data sheet status

Datasheet status	Product status	Definition <sup>[1]</sup>
Objective specification	Development	This data sheet contains the design target or goal specifications for product development. Specification may change in any manner without notice.
Preliminary specification	Qualification	This data sheet contains preliminary data, and supplementary data will be published at a later date. Philips Semiconductors reserves the right to make changes at any time without notice in order to improve design and supply the best possible product.
Product specification	Production	This data sheet contains final specifications. Philips Semiconductors reserves the right to make changes at any time without notice in order to improve design and supply the best possible product.

[1] Please consult the most recently issued data sheet before initiating or completing a design.

## 20. Definitions

**Short-form specification** — The data in a short-form specification is extracted from a full data sheet with the same type number and title. For detailed information see the relevant data sheet or data handbook.

**Limiting values definition** — Limiting values given are in accordance with the Absolute Maximum Rating System (IEC 60134). Stress above one or more of the limiting values may cause permanent damage to the device. These are stress ratings only and operation of the device at these or at any other conditions above those given in the Characteristics sections of the specification is not implied. Exposure to limiting values for extended periods may affect device reliability.

**Application information** — Applications that are described herein for any of these products are for illustrative purposes only. Philips Semiconductors make no representation or warranty that such applications will be suitable for the specified use without further testing or modification.

## 21. Disclaimers

**Life support** — These products are not designed for use in life support appliances, devices, or systems where malfunction of these products can reasonably be expected to result in personal injury. Philips Semiconductors customers using or selling these products for use in such applications do so at their own risk and agree to fully indemnify Philips Semiconductors for any damages resulting from such application.

**Right to make changes** — Philips Semiconductors reserves the right to make changes, without notice, in the products, including circuits, standard cells, and/or software, described or contained herein in order to improve design and/or performance. Philips Semiconductors assumes no responsibility or liability for the use of any of these products, conveys no licence or title under any patent, copyright, or mask work right to these products, and makes no representations or warranties that these products are free from patent, copyright, or mask work right infringement, unless otherwise specified.

## Philips Semiconductors - a worldwide company

**Argentina:** see South America

**Australia:** Tel. +61 2 9704 8141, Fax. +61 2 9704 8139

**Austria:** Tel. +43 160 101, Fax. +43 160 101 1210

**Belarus:** Tel. +375 17 220 0733, Fax. +375 17 220 0773

**Belgium:** see The Netherlands

**Brazil:** see South America

**Bulgaria:** Tel. +359 268 9211, Fax. +359 268 9102

**Canada:** Tel. +1 800 234 7381

**China/Hong Kong:** Tel. +852 2 319 7888, Fax. +852 2 319 7700

**Colombia:** see South America

**Czech Republic:** see Austria

**Denmark:** Tel. +45 3 288 2636, Fax. +45 3 157 0044

**Finland:** Tel. +358 961 5800, Fax. +358 96 158 0920

**France:** Tel. +33 14 099 6161, Fax. +33 14 099 6427

**Germany:** Tel. +49 40 23 5360, Fax. +49 402 353 6300

**Hungary:** see Austria

**India:** Tel. +91 22 493 8541, Fax. +91 22 493 8722

**Indonesia:** see Singapore

**Ireland:** Tel. +353 17 64 0000, Fax. +353 17 64 0200

**Israel:** Tel. +972 36 45 0444, Fax. +972 36 49 1007

**Italy:** Tel. +39 039 203 6838, Fax +39 039 203 6800

**Japan:** Tel. +81 33 740 5130, Fax. +81 3 3740 5057

**Korea:** Tel. +82 27 09 1412, Fax. +82 27 09 1415

**Malaysia:** Tel. +60 37 50 5214, Fax. +60 37 57 4880

**Mexico:** Tel. +9-5 800 234 7381

**Middle East:** see Italy

**For all other countries apply to:** Philips Semiconductors,  
International Marketing & Sales Communications,  
Building BE, P.O. Box 218, 5600 MD EINDHOVEN,  
The Netherlands, Fax. +31 40 272 4825

**Netherlands:** Tel. +31 40 278 2785, Fax. +31 40 278 8399

**New Zealand:** Tel. +64 98 49 4160, Fax. +64 98 49 7811

**Norway:** Tel. +47 22 74 8000, Fax. +47 22 74 8341

**Philippines:** Tel. +63 28 16 6380, Fax. +63 28 17 3474

**Poland:** Tel. +48 22 5710 000, Fax. +48 22 5710 001

**Portugal:** see Spain

**Romania:** see Italy

**Russia:** Tel. +7 095 755 6918, Fax. +7 095 755 6919

**Singapore:** Tel. +65 350 2538, Fax. +65 251 6500

**Slovakia:** see Austria

**Slovenia:** see Italy

**South Africa:** Tel. +27 11 471 5401, Fax. +27 11 471 5398

**South America:** Tel. +55 11 821 2333, Fax. +55 11 829 1849

**Spain:** Tel. +34 33 01 6312, Fax. +34 33 01 4107

**Sweden:** Tel. +46 86 32 2000, Fax. +46 86 32 2745

**Switzerland:** Tel. +41 14 88 2686, Fax. +41 14 81 7730

**Taiwan:** Tel. +886 22 134 2865, Fax. +886 22 134 2874

**Thailand:** Tel. +66 27 45 4090, Fax. +66 23 98 0793

**Turkey:** Tel. +90 216 522 1500, Fax. +90 216 522 1813

**Ukraine:** Tel. +380 44 264 2776, Fax. +380 44 268 0461

**United Kingdom:** Tel. +44 208 730 5000, Fax. +44 208 754 8421

**United States:** Tel. +1 800 234 7381

**Uruguay:** see South America

**Vietnam:** see Singapore

**Yugoslavia:** Tel. +381 11 3341 299, Fax. +381 11 3342 553

**Internet:** <http://www.semiconductors.philips.com>

(SCA69)

## Contents

<b>1</b>	<b>General description</b> . . . . .	<b>1</b>
<b>2</b>	<b>Features</b> . . . . .	<b>1</b>
<b>3</b>	<b>Applications</b> . . . . .	<b>1</b>
<b>4</b>	<b>Quick reference data</b> . . . . .	<b>1</b>
<b>5</b>	<b>Ordering information</b> . . . . .	<b>2</b>
<b>6</b>	<b>Block diagram</b> . . . . .	<b>2</b>
<b>7</b>	<b>Pinning information</b> . . . . .	<b>3</b>
7.1	Pinning . . . . .	3
7.2	Pin description . . . . .	3
<b>8</b>	<b>Functional description</b> . . . . .	<b>4</b>
8.1	Input configuration . . . . .	4
8.2	Power amplifier . . . . .	5
8.2.1	Output power measurement . . . . .	5
8.2.2	Headroom . . . . .	5
8.3	Mode selection . . . . .	5
8.3.1	Switch-on and switch-off . . . . .	6
8.4	Supply Voltage Ripple Rejection (SVRR) . . . . .	6
8.5	Built-in protection circuits . . . . .	6
8.5.1	Short-circuit protection . . . . .	6
8.5.2	Thermal shutdown protection . . . . .	6
<b>9</b>	<b>Limiting values</b> . . . . .	<b>7</b>
<b>10</b>	<b>Thermal characteristics</b> . . . . .	<b>7</b>
<b>11</b>	<b>Static characteristics</b> . . . . .	<b>7</b>
<b>12</b>	<b>Dynamic characteristics</b> . . . . .	<b>8</b>
<b>13</b>	<b>Internal circuitry</b> . . . . .	<b>12</b>
<b>14</b>	<b>Application information</b> . . . . .	<b>13</b>
14.1	Printed-circuit board (PCB) . . . . .	13
14.1.1	Layout and grounding . . . . .	13
14.1.2	Power supply decoupling . . . . .	14
14.2	Thermal behaviour and heatsink calculation . . . . .	15
<b>15</b>	<b>Test information</b> . . . . .	<b>15</b>
15.1	Quality information . . . . .	15
15.2	Test conditions . . . . .	15
<b>16</b>	<b>Package outline</b> . . . . .	<b>16</b>
<b>17</b>	<b>Soldering</b> . . . . .	<b>17</b>
17.1	Introduction to soldering through-hole mount packages . . . . .	17
17.2	Soldering by dipping or by solder wave . . . . .	17
17.3	Manual soldering . . . . .	17
17.4	Package related soldering information . . . . .	17
<b>18</b>	<b>Revision history</b> . . . . .	<b>18</b>
<b>19</b>	<b>Data sheet status</b> . . . . .	<b>19</b>
<b>20</b>	<b>Definitions</b> . . . . .	<b>19</b>
<b>21</b>	<b>Disclaimers</b> . . . . .	<b>19</b>



# PHILIPS

*Let's make things better.*