

SANYO

No.2168B

L78MR00 Series

5 to 12V 0.5A 5-Pin
Voltage Regulators with Reset Function

The L78MR00 series, 500mA general-purpose voltage regulator ICs provide reset output signal for micro computers.

Features

- Reset function (power supply voltage monitor : Generates a reset signal at a power-on and temporal power-down).
- Output voltage

L78MR05 : 5V	(Reset output	On-chip pull-up resistor)
L78MR06 : 6V	(Reset output	Open collector)
L78MR08 : 8V	(Reset output	Open collector)
L78MR09 : 9V	(Reset output	Open collector)
L78MR12 : 12V	(Reset output	Open collector)
- Output current 500mA
- On-chip ASO protector.
- On-chip thermal protector.
- On-chip over current limiter.
- The use of package TO220-5H facilitates easy mounting and thermal design.
- Delay time (t_d) may be set by an external capacitor.

[Common to L78MR00 Series]

Maximum Ratings at $T_a = 25^\circ\text{C}$

				unit
Maximum Input Voltage	$V_{IN\ max}$		35	V
Reset Pin Supply Voltage	V_{reset}		35	V
Allowable Power Dissipation	$P_d\ max$	No fin	1.75	W
		$T_C = 25^\circ\text{C}$	20	W
Operating Temperature	T_{opr}		-30 to +80	$^\circ\text{C}$
Storage Temperature	T_{stg}		-55 to +150	$^\circ\text{C}$

Equivalent Circuit Block Diagram

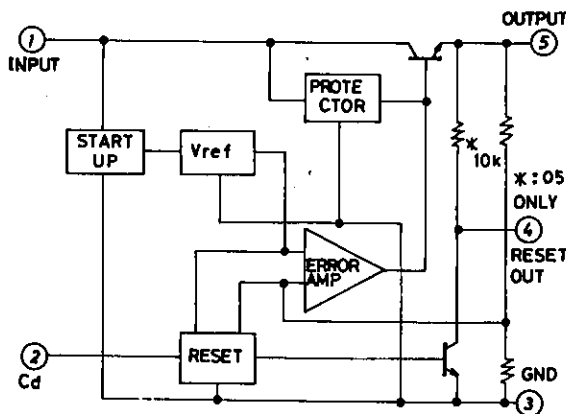

Unit (resistance: Ω)

Package Dimensions
(unit: mm)

3079

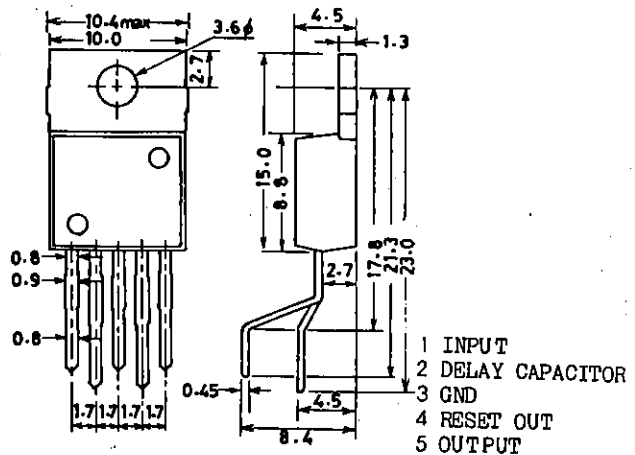

SANYO : TO-220 5H

SANYO Electric Co., Ltd. Semiconductor Business Headquarters
TOKYO OFFICE Tokyo Bldg., 1-10, 1 Chome, Ueno, Taito-ku, TOKYO, 110 JAPAN

L78MR00 Series

[L78MR05]

Recommended Operating Conditions at $T_a = 25^\circ\text{C}$

Parameter	Symbol	Value	unit
Input Voltage	V_{IN}	7.5 to 20	V
Output Current	I_o	5 to 500	mA

Operating Characteristics at $T_a = 25^\circ\text{C}$, $V_{IN} = 10\text{V}$, $I_o = 0.35\text{A}$, $C_o = 10\mu\text{F}$

Parameter	Symbol	Conditions	min	typ	max	unit
Output Voltage	V_{o1}	$T_j = 25^\circ\text{C}$	4.8	5.0	5.2	V
	V_{o2}	$7\text{V} \leq V_{IN} \leq 20\text{V}$, $5\text{mA} \leq I_o \leq 0.35\text{A}$	4.75		5.25	V
Line Regulation	ΔV_o	LN1 $T_j = 25^\circ\text{C}$, $7\text{V} \leq V_{IN} \leq 25\text{V}$, $I_o = 0.2\text{A}$		1.0	100	mV
		LN2 $T_j = 25^\circ\text{C}$, $8\text{V} \leq V_{IN} \leq 25\text{V}$, $I_o = 0.2\text{A}$		0.5	50	mV
Load Regulation	ΔV_o	LD1 $T_j = 25^\circ\text{C}$, $5\text{mA} \leq I_o \leq 0.5\text{A}$		3.0	100	mV
		LD2 $T_j = 25^\circ\text{C}$, $5\text{mA} \leq I_o \leq 0.2\text{A}$		1.5	50	mV
Current Dissipation	I_{CC}	$T_j = 25^\circ\text{C}$	3.4		6.0	mA
Current Dissipation Variation (Line)	ΔI_{CC}	LN $8\text{V} \leq V_{IN} \leq 25\text{V}$, $I_o \leq 0.2\text{A}$			0.8	mA
		LD $5\text{mA} \leq I_o \leq 0.35\text{A}$			0.5	mA
Output Noise Voltage	V_{NO}	$I_o = 5\text{mA}$, $10\text{Hz} \leq f \leq 100\text{kHz}$		60		μV
Ripple Rejection	Rr1	$T_j = 25^\circ\text{C}$, $f = 120\text{Hz}$, $8\text{V} \leq V_{IN} \leq 18\text{V}$, $I_o = 0.1\text{A}$	62	80		dB
	Rr2	$T_j = 25^\circ\text{C}$, $f = 120\text{Hz}$, $8\text{V} \leq V_{IN} \leq 18\text{V}$, $I_o = 0.3\text{A}$	62	77		dB
Dropout Voltage	V_{drop}			2.0	2.5	V
Peak Output Current	I_{OP}	$T_j = 25^\circ\text{C}$		1.1		A
Short Circuit Current	I_{OSC}	$T_j = 25^\circ\text{C}$, $V_{IN} = 35\text{V}$		0.02		A
Temperature Coefficient of Output Voltage	$\Delta V_o/\Delta T$	$I_o = 5\text{mA}$, $T_j = 25$ to 125°C	-0.3			mV/ $^\circ\text{C}$
'L' Reset Output Voltage	V_{ORL}	$V_o \leq 4.5\text{V}$, $I_o = 5\text{mA}$			0.2	V
Reset Threshold Voltage	V_{RT}	$I_o = 5\text{mA}$		$V_o - 0.3V_o - 0.2$		V
Reset Hysteresis Voltage	V_{RTH}	$I_o = 5\text{mA}$		100		mV
Reset Output Delay Time	t_d	$C_d = 0.1\mu\text{F}$, $I_o = 5\text{mA}$		10		ms

[L78MR06]

Recommended Operating Conditions at $T_a = 25^\circ\text{C}$

Parameter	Symbol	Value	unit
Input Voltage	V_{IN}	8.5 to 21	V
Output Current	I_o	5 to 500	mA
Reset Output Current	I_{oR}	$V_o \leq 5.64\text{V}$	20 mA max

Operating Characteristics at $T_a = 25^\circ\text{C}$, $V_{IN} = 11\text{V}$, $I_o = 0.35\text{A}$, $C_o = 10\mu\text{F}$

Parameter	Symbol	Conditions	min	typ	max	unit
Output Voltage	V_{o1}	$T_j = 25^\circ\text{C}$	5.75	6.0	6.25	V
	V_{o2}	$8\text{V} \leq V_{IN} \leq 21\text{V}$, $5\text{mA} \leq I_o \leq 0.35\text{A}$	5.7		6.3	V
Line Regulation	ΔV_o	LN1 $T_j = 25^\circ\text{C}$, $8\text{V} \leq V_{IN} \leq 25\text{V}$, $I_o = 0.2\text{A}$		1.2	100	mV
		LN2 $T_j = 25^\circ\text{C}$, $9\text{V} \leq V_{IN} \leq 25\text{V}$, $I_o = 0.2\text{A}$		0.6	50	mV
Load Regulation	ΔV_o	LD1 $T_j = 25^\circ\text{C}$, $5\text{mA} \leq I_o \leq 0.5\text{A}$		4.0	120	mV
		LD2 $T_j = 25^\circ\text{C}$, $5\text{mA} \leq I_o \leq 0.2\text{A}$		2.0	60	mV
Current Dissipation	I_{CC}	$T_j = 25^\circ\text{C}$	3.4		6.0	mA
Current Dissipation Variation (Line)	ΔI_{CC}	LN $9\text{V} \leq V_{IN} \leq 25\text{V}$, $I_o \leq 0.2\text{A}$			0.8	mA
		LD $5\text{mA} \leq I_o \leq 0.35\text{A}$			0.5	mA
Output Noise Voltage	V_{NO}	$I_o = 5\text{mA}$, $10\text{Hz} \leq f \leq 100\text{kHz}$		70		μV
Ripple Rejection	Rr1	$T_j = 25^\circ\text{C}$, $f = 120\text{Hz}$, $9\text{V} \leq V_{IN} \leq 19\text{V}$, $I_o = 0.1\text{A}$	59	80		dB
	Rr2	$T_j = 25^\circ\text{C}$, $f = 120\text{Hz}$, $9\text{V} \leq V_{IN} \leq 19\text{V}$, $I_o = 0.3\text{A}$	59	75		dB

Continued on next page.

L78MR00 Series

Continued from preceding page.

			min	typ	max	unit
Dropout Voltage	V_{drop}			2.0	2.5	V
Peak Output Current	I_{OP}	$T_j = 25^\circ\text{C}$		1.1		A
Short Circuit Current	I_{OSC}	$T_j = 25^\circ\text{C}, V_{IN} = 35\text{V}$		0.02		A
Temperature Coefficient of Output Voltage	$\Delta V_o/\Delta T$	$I_o = 5\text{mA}, T_j = 25 \text{ to } 125^\circ\text{C}$		-0.4		mV/°C
'L' Reset Output Voltage	V_{ORL}	$V_o \leq 5.64\text{V}, I_{OR} = 20\text{mA}, I_o = 5\text{mA}$			0.8	V
Reset Output Leakage Current	I_{RL}	$V_R = 35\text{V}$			50	μA
Reset Threshold Voltage	V_{RT}	$I_o = 5\text{mA}$	$V_o - 0.36$	$V_o - 0.24$		V
Reset Hysteresis Voltage	V_{RTH}	$I_o = 5\text{mA}$		120		mV
Reset Output Delay Time	t_d	$C_d = 0.1\mu\text{F}, I_o = 5\text{mA}$		10		ms

[L78MR08]

Recommended Operating Conditions at $T_a = 25^\circ\text{C}$

				unit
Input Voltage	V_{IN}		10.5 to 23	V
Output Current	I_o		5 to 500	mA
Reset Output Current	I_{OR}	$V_o \leq 7.2\text{V}$	20	mA max

Operating Characteristics at $T_a = 25^\circ\text{C}, V_{IN} = 14\text{V}, I_o = 0.35\text{A}, C_o = 10\mu\text{F}$

			min	typ	max	unit
Output Voltage	V_{o1}	$T_j = 25^\circ\text{C}$	7.7	8.0	8.3	V
	V_{o2}	$10.5\text{V} \leq V_{IN} \leq 23\text{V},$ $5\text{mA} \leq I_o \leq 0.35\text{A}$	7.6		8.4	V
Line Regulation	ΔV_o	LN1 $T_j = 25^\circ\text{C}, 10.5\text{V} \leq V_{IN} \leq 25\text{V},$ $I_o = 0.2\text{A}$		1.6	100	mV
		LN2 $T_j = 25^\circ\text{C}, 11\text{V} \leq V_{IN} \leq 25\text{V},$ $I_o = 0.2\text{A}$		0.8	50	mV
Load Regulation	ΔV_o	LD1 $T_j = 25^\circ\text{C}, 5\text{mA} \leq I_o \leq 0.5\text{A}$		5.0	160	mV
		LD2 $T_j = 25^\circ\text{C}, 5\text{mA} \leq I_o \leq 0.2\text{A}$		2.0	80	mV
Current Dissipation	I_{CC}	$T_j = 25^\circ\text{C}$		3.5	6.0	mA
Current Dissipation Variation (Line)	ΔI_{CC}	LN $10.5\text{V} \leq V_{IN} \leq 25\text{V}, I_o \leq 0.2\text{A}$			0.8	mA
Current Dissipation Variation (Load)	ΔI_{CC}	LD $5\text{mA} \leq I_o \leq 0.35\text{A}$			0.5	mA
Output Noise Voltage	V_{NO}	$I_o = 5\text{mA}, 10\text{Hz} \leq f \leq 100\text{kHz}$		100		μV
Ripple Rejection	Rr1	$T_j = 25^\circ\text{C}, f = 120\text{Hz},$ $11.5\text{V} \leq V_{IN} \leq 21.5\text{V}, I_o = 0.1\text{A}$	56	75		dB
	Rr2	$T_j = 25^\circ\text{C}, f = 120\text{Hz},$ $11.5\text{V} \leq V_{IN} \leq 21.5\text{V}, I_o = 0.3\text{A}$	56	71		dB
Dropout Voltage	V_{drop}			2.0	2.5	V
Peak Output Current	I_{OP}	$T_j = 25^\circ\text{C}$		1.1		A
Short Circuit Current	I_{OSC}	$T_j = 25^\circ\text{C}, V_{IN} = 35\text{V}$		0.02		A
Temperature Coefficient of Output Voltage	$\Delta V_o/\Delta T$	$I_o = 5\text{mA}, T_j = 25 \text{ to } 125^\circ\text{C}$		-0.7		mV/°C
'L' Reset Output Voltage	V_{ORL}	$V_o \leq 7.2\text{V}, I_{OR} = 20\text{mA}, I_o = 5\text{mA}$			0.8	V
Reset Output Leakage Current	I_{RL}	$V_R = 35\text{V}$			50	μA
Reset Threshold Voltage	V_{RT}	$I_o = 5\text{mA}$	$V_o - 0.48$	$V_o - 0.32$		V
Reset Hysteresis Voltage	V_{RTH}	$I_o = 5\text{mA}$		160		mV
Reset Output Delay Time	t_d	$C_d = 0.1\mu\text{F}, I_o = 5\text{mA}$		10		ms

L78MR00 Series

[L78MR09]

Recommended Operating Conditions at $T_a = 25^\circ\text{C}$

Parameter	Symbol	Condition	min	typ	max	unit
Input Voltage	V_{IN}			12 to 24		V
Output Current	I_o			5 to 500		mA
Reset Output Current	I_{OR}	$V_o \leq 8.1\text{V}$		20		mA max

Operating Characteristics at $T_a = 25^\circ\text{C}$, $V_{IN} = 15\text{V}$, $I_o = 0.35\text{A}$, $C_o = 10\mu\text{F}$

Parameter	Symbol	Condition	min	typ	max	unit
Output Voltage	V_{o1}	$T_j = 25^\circ\text{C}$	8.6	9.0	9.4	V
	V_{o2}	$11.5\text{V} \leq V_{IN} \leq 24\text{V}$, $5\text{mA} \leq I_o \leq 0.35\text{A}$	8.5		9.5	V
Line Regulation	ΔV_o	LN1 $T_j = 25^\circ\text{C}$, $11.5\text{V} \leq V_{IN} \leq 25\text{V}$, $I_o = 0.2\text{A}$		1.6	100	mV
		LN2 $T_j = 25^\circ\text{C}$, $12\text{V} \leq V_{IN} \leq 25\text{V}$, $I_o = 0.2\text{A}$		0.8	50	mV
Load Regulation	ΔV_o	LD1 $T_j = 25^\circ\text{C}$, $5\text{mA} \leq I_o \leq 0.5\text{A}$		5.0	180	mV
		LD2 $T_j = 25^\circ\text{C}$, $5\text{mA} \leq I_o \leq 0.2\text{A}$		3.0	90	mV
Current Dissipation	I_{CC}	$T_j = 25^\circ\text{C}$		3.5	6.0	mA
Current Dissipation Variation (Line)	ΔI_{CC}	LN $11.5\text{V} \leq V_{IN} \leq 25\text{V}$, $I_o \leq 0.2\text{A}$			0.8	mA
		LD $5\text{mA} \leq I_o \leq 0.35\text{A}$			0.5	mA
Output Noise Voltage	V_{NO}	$I_o = 5\text{mA}$, $10\text{Hz} \leq f \leq 100\text{kHz}$		110		μV
Ripple Rejection	R_{r1}	$T_j = 25^\circ\text{C}$, $f = 120\text{Hz}$, $12\text{V} \leq V_{IN} \leq 22\text{V}$, $I_o = 0.1\text{A}$	56	73		dB
		$T_j = 25^\circ\text{C}$, $f = 120\text{Hz}$, $12\text{V} \leq V_{IN} \leq 22\text{V}$, $I_o = 0.3\text{A}$	56	70		dB
Dropout Voltage	V_{drop}			2.0	2.5	V
Peak Output Current	I_{OP}	$T_j = 25^\circ\text{C}$		1.1		A
Short Circuit Current	I_{OSC}	$T_j = 25^\circ\text{C}$, $V_{IN} = 35\text{V}$		0.02		A
Temperature Coefficient of Output Voltage	$\Delta V_o / \Delta T$	$I_o = 5\text{mA}$, $T_j = 25$ to 125°C	-0.9			mV/ $^\circ\text{C}$
'L' Reset Output Voltage	V_{ORL}	$V_o \leq 8.1\text{V}$, $I_{OR} = 20\text{mA}$, $I_o = 5\text{mA}$			0.8	V
Reset Output Leakage Current	I_{RL}	$V_R = 35\text{V}$			50	μA
Reset Threshold Voltage	V_{RT}	$I_o = 5\text{mA}$		$V_o - 0.54 V_o - 0.36$		V
Reset Hysteresis Voltage	V_{RTH}	$I_o = 5\text{mA}$		180		mV
Reset Output Delay Time	t_d	$C_d = 0.1\mu\text{F}$, $I_o = 5\text{mA}$		10		ms

[L78MR12]

Recommended Operating Conditions at $T_a = 25^\circ\text{C}$

Parameter	Symbol	Condition	min	typ	max	unit
Input Voltage	V_{IN}			15 to 27		V
Output Current	I_o			5 to 500		mA
Reset Output Current	I_{OR}	$V_o \leq 10.8\text{V}$		20		mA max

Operating Characteristics at $T_a = 25^\circ\text{C}$, $V_{IN} = 19\text{V}$, $I_o = 0.35\text{A}$, $C_o = 10\mu\text{F}$

Parameter	Symbol	Condition	min	typ	max	unit
Output Voltage	V_{o1}	$T_j = 25^\circ\text{C}$	11.5	12.0	12.5	V
	V_{o2}	$14.5\text{V} \leq V_{IN} \leq 27\text{V}$, $5\text{mA} \leq I_o \leq 0.35\text{A}$	11.4		12.6	V
Line Regulation	ΔV_o	LN1 $T_j = 25^\circ\text{C}$, $14.5\text{V} \leq V_{IN} \leq 30\text{V}$, $I_o = 0.2\text{A}$		2.4	100	mV
		LN2 $T_j = 25^\circ\text{C}$, $16\text{V} \leq V_{IN} \leq 30\text{V}$, $I_o = 0.2\text{A}$		1.2	50	mV
Load Regulation	ΔV_o	LD1 $T_j = 25^\circ\text{C}$, $5\text{mA} \leq I_o \leq 0.5\text{A}$		7.0	240	mV
		LD2 $T_j = 25^\circ\text{C}$, $5\text{mA} \leq I_o \leq 0.2\text{A}$		4.0	120	mV
Current Dissipation	I_{CC}	$T_j = 25^\circ\text{C}$		3.7	6.0	mA

Continued on next page.

L78MR00 Series

Continued from preceding page.

				min	typ	max	unit
Current Dissipation Variation (Line)	ΔI_{CC} LN	$14.5V \leq V_{IN} \leq 30V, I_o \leq 0.2A$				0.8	mA
		ΔI_{CC} LD	$5mA \leq I_o \leq 0.35A$				0.5
Output Noise Voltage	V_{NO}	$I_o = 5mA, 10Hz \leq f \leq 100kHz$			140		μV
Ripple Rejection	Rr1	$T_j = 25^\circ C, f = 120Hz,$		55	68		dB
		$15V \leq V_{IN} \leq 25V, I_o = 0.1A$					
		Rr2	$T_j = 25^\circ C, f = 120Hz,$		55	66	
		$15V \leq V_{IN} \leq 25V, I_o = 0.3A$					
Dropout Voltage	V_{drop}				2.0	2.5	V
Peak Output Current	I_{OP}	$T_j = 25^\circ C$			1.1		A
Short Circuit Current	I_{OSC}	$T_j = 25^\circ C, V_{IN} = 35V$			0.02		A
Temperature Coefficient of Output Voltage	$\Delta V_o / \Delta T$	$I_o = 5mA, T_j = 25 \text{ to } 125^\circ C$			-1.6		mV/°C
'L' Reset Output Voltage	V_{ORL}	$V_o \leq 10.8V, I_{OR} = 20mA, I_o = 5mA$				0.8	V
Reset Output Leakage Current	I_{RL}	$V_R = 35V$				50	μA
Reset Threshold Voltage	V_{RT}	$I_o = 5mA$			$V_o - 0.72$	$V_o - 0.48$	V
Reset Hysteresis Voltage	V_{RTH}	$I_o = 5mA$			240		mV
Reset Output Delay Time	t_d	$C_d = 0.1\mu F, I_o = 5mA$			10		ms

Sample Application Circuit

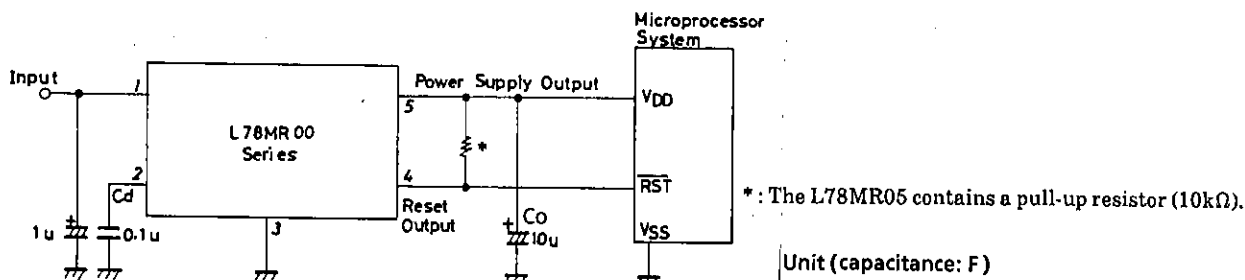

Note on use) If a load current (in particular, pulse-like load current) that is greater than a rated value is used, a reset signal may be generated due to the overload. Please keep it in mind.

L78MR05 Reset Operation

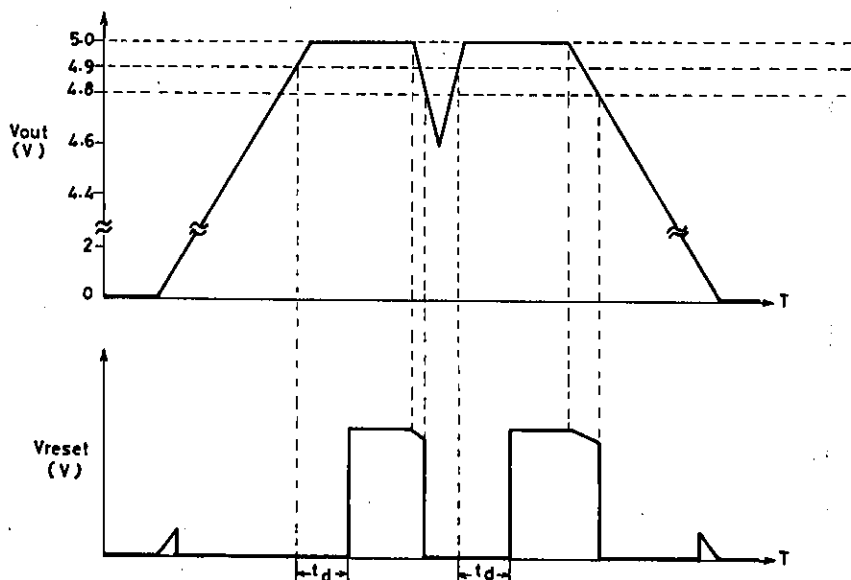

L78MR00 Series

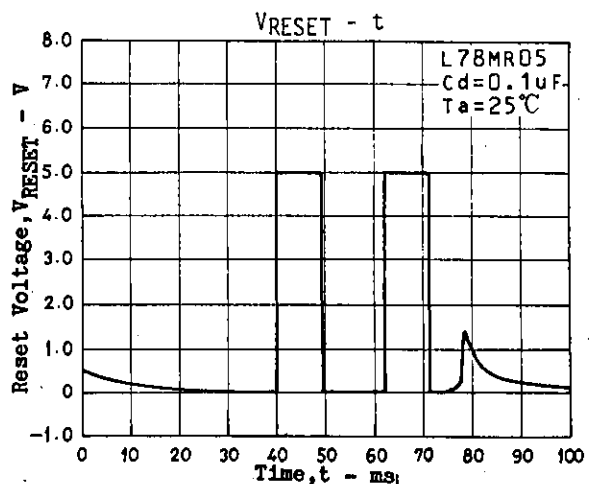
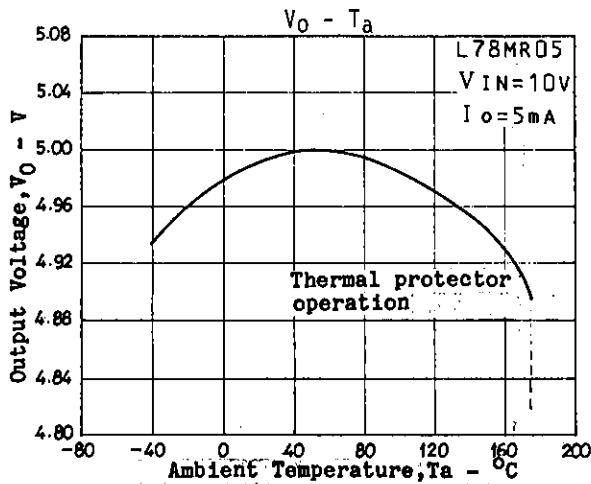
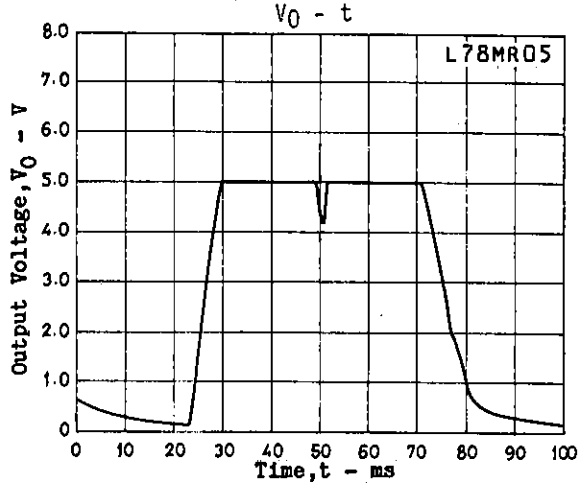
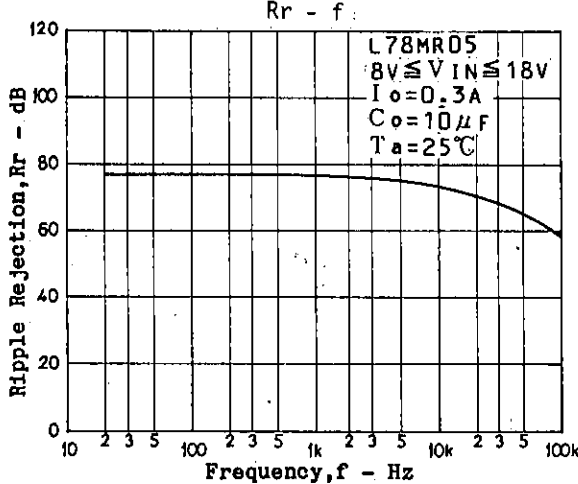
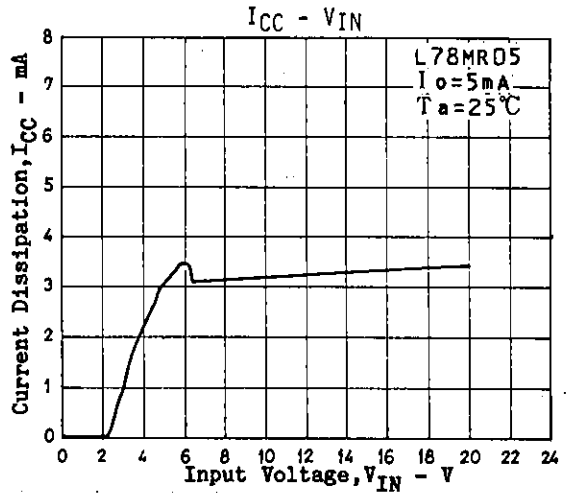
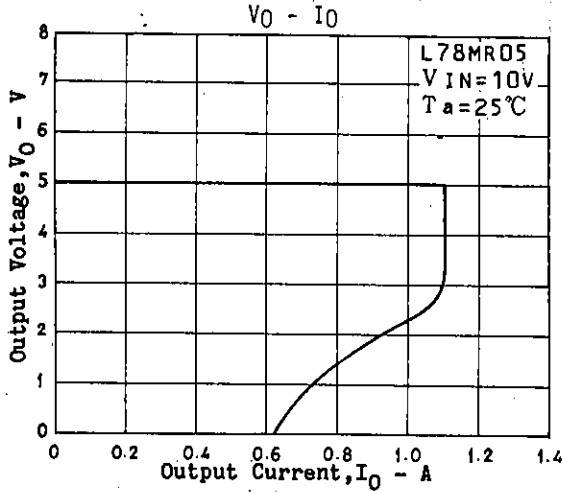
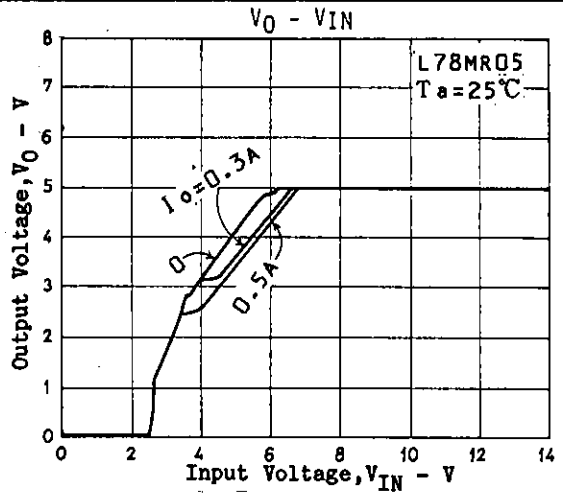
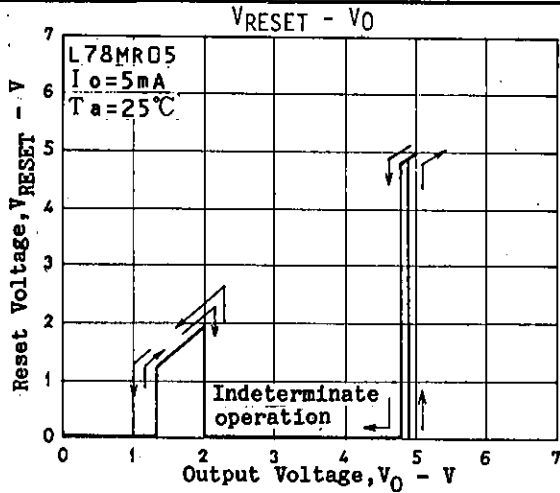

L78MR00 Series

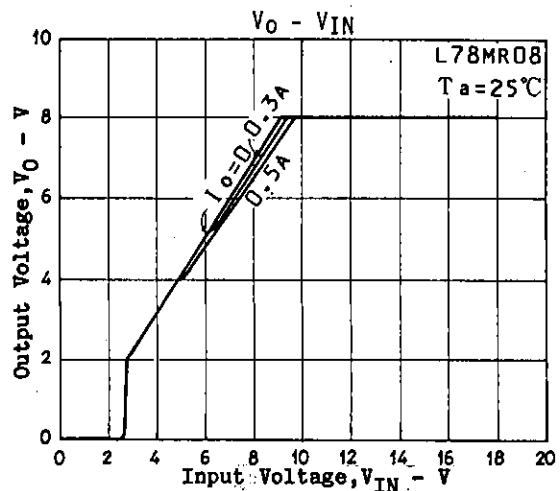
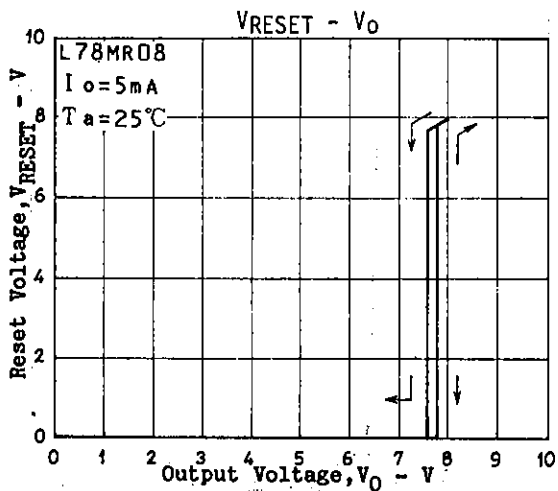
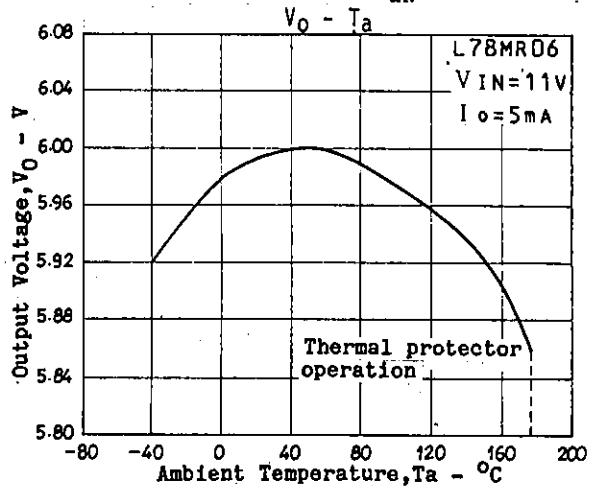
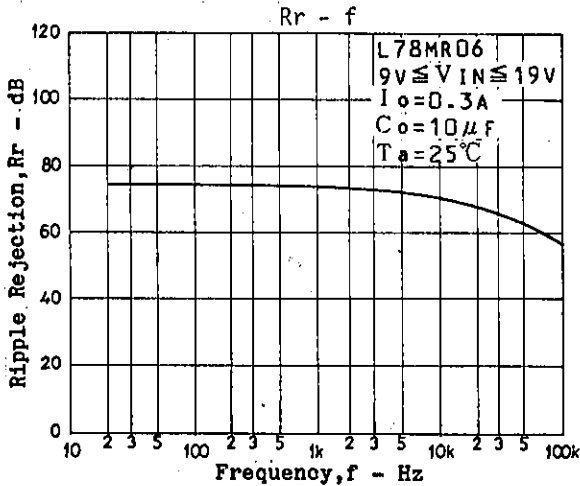
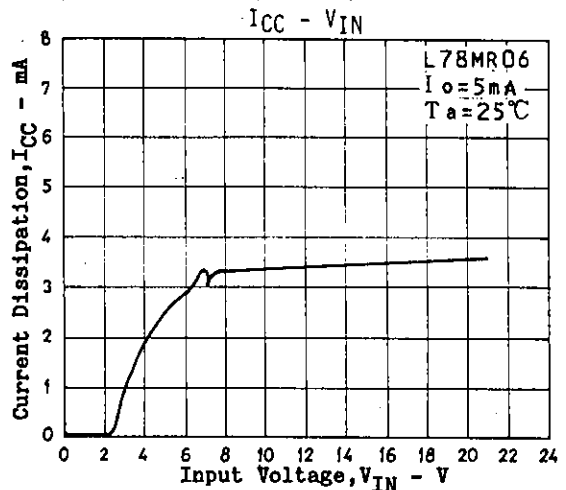
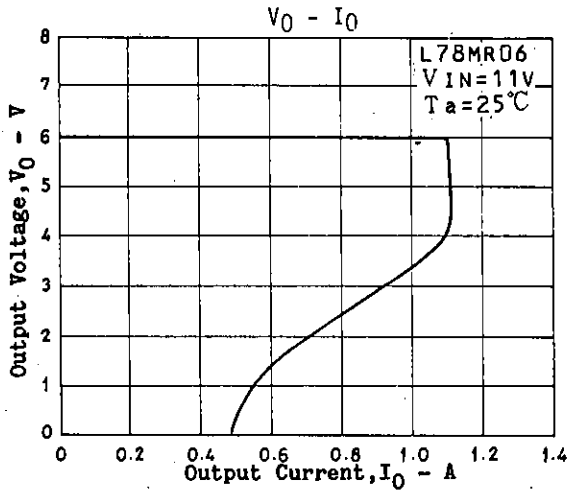
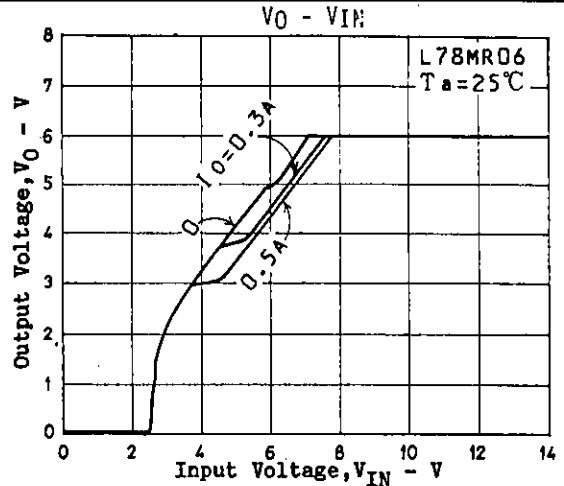
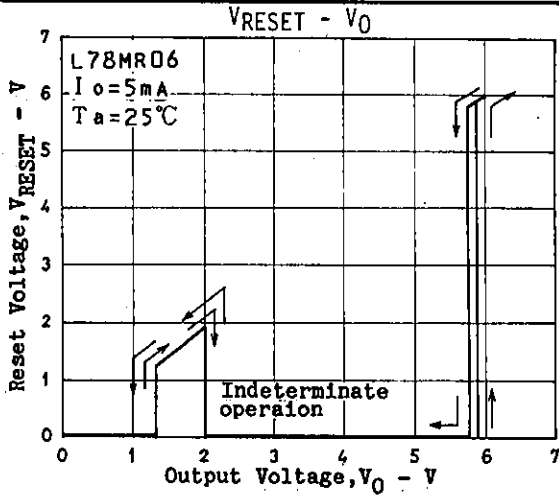

L78MR00 Series

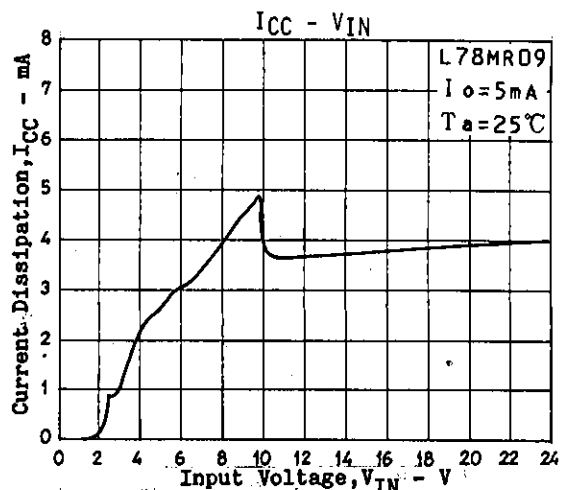
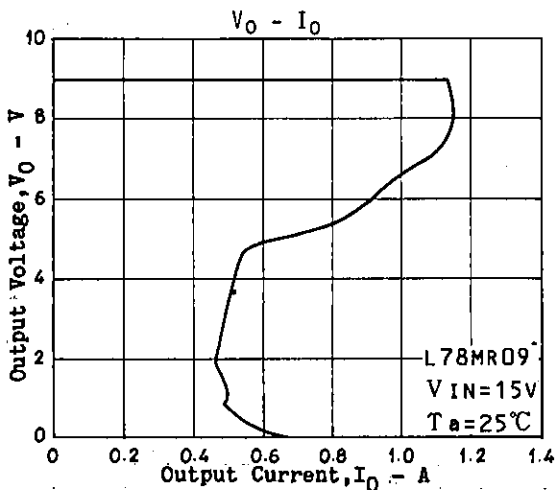
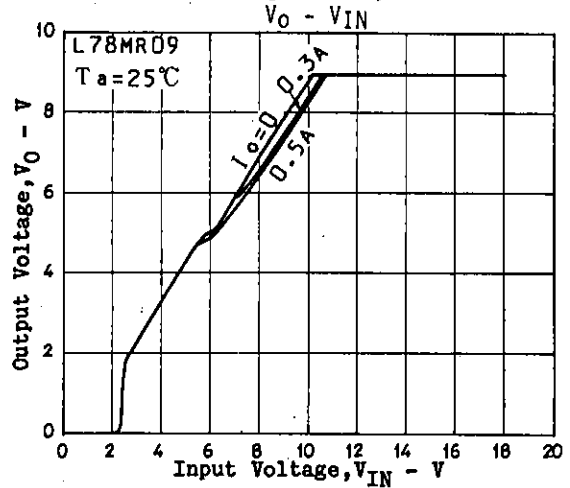
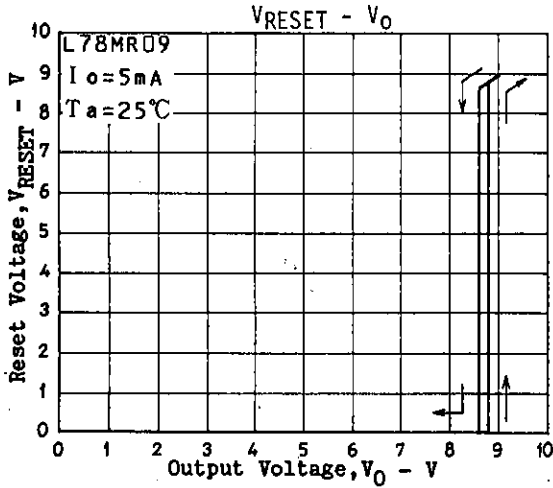
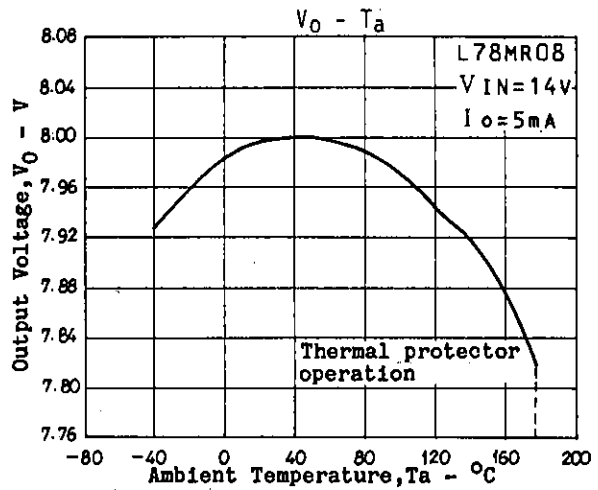
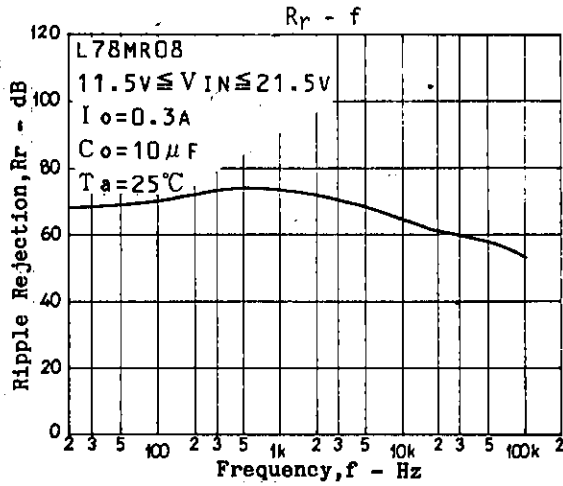
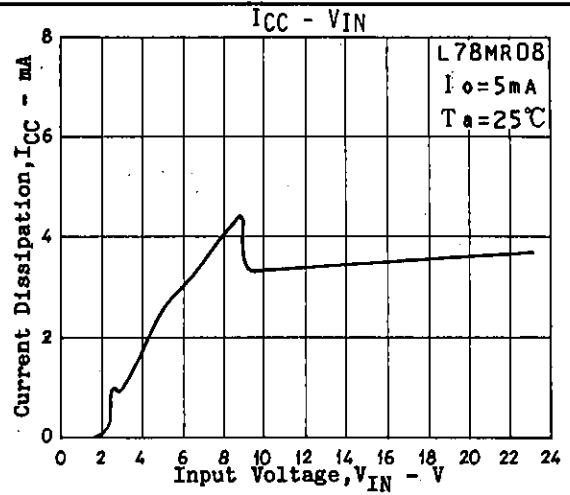
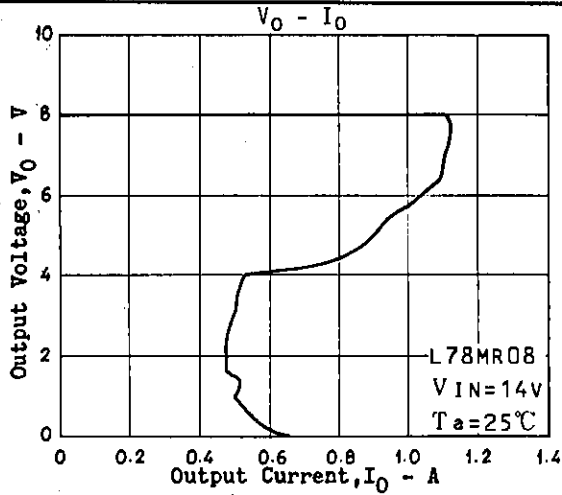

L78MR00 Series

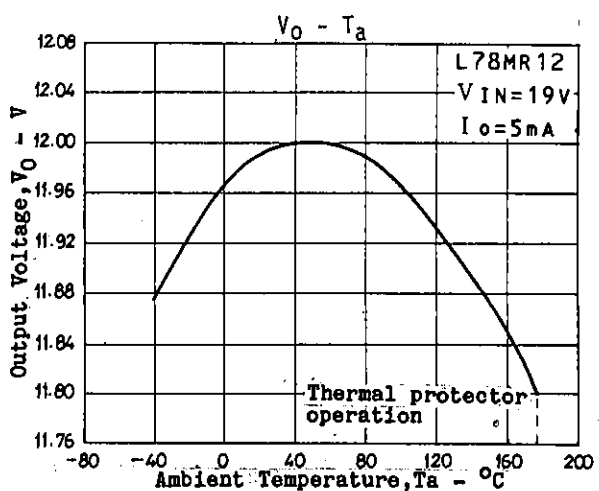
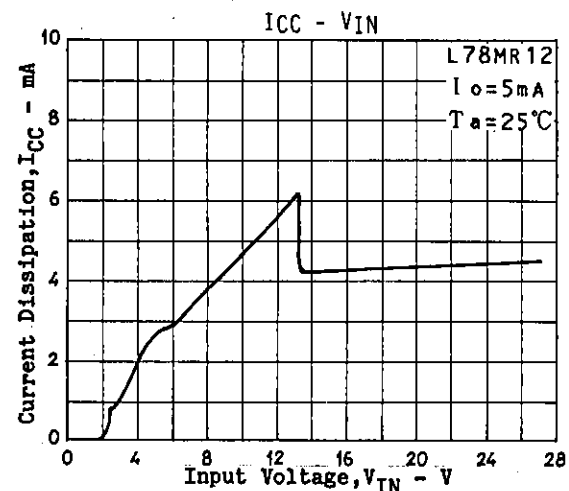
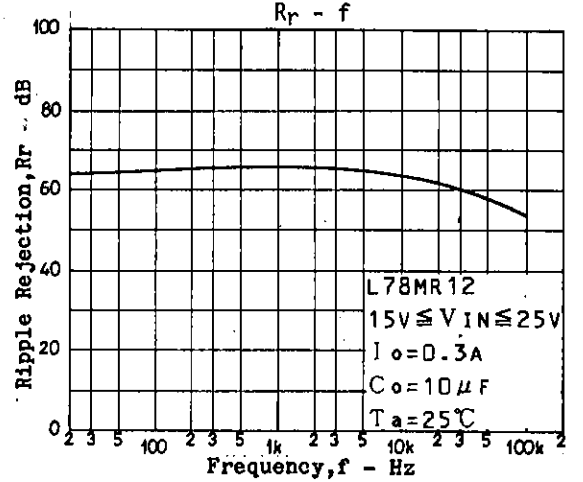
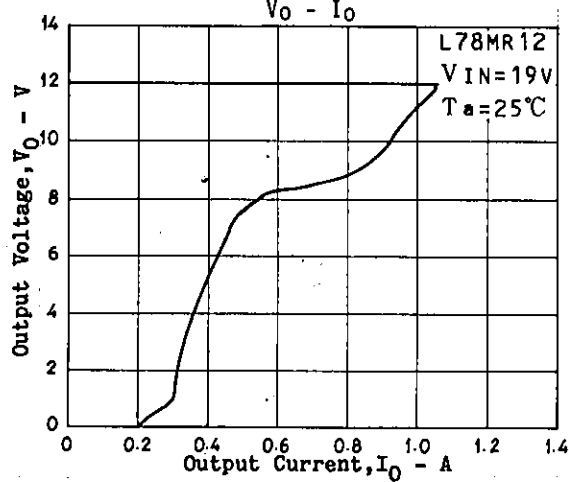
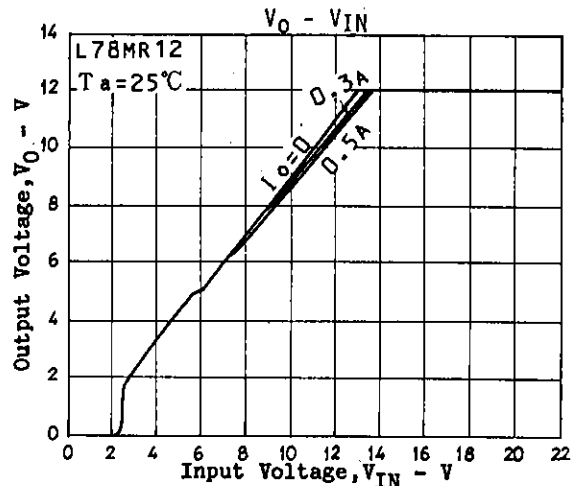
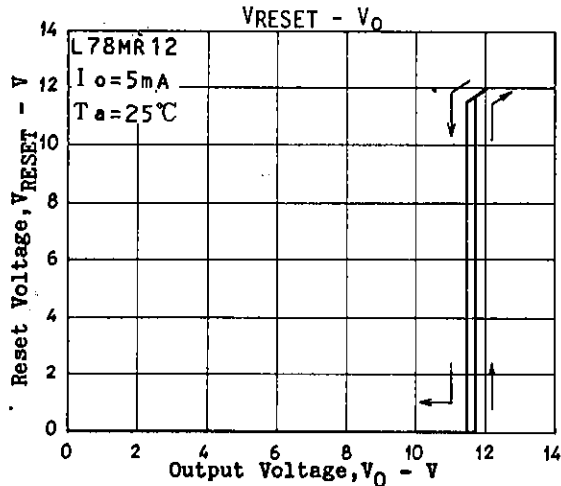
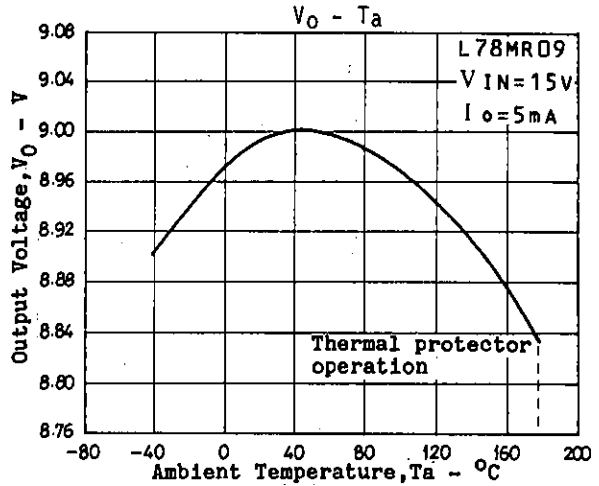
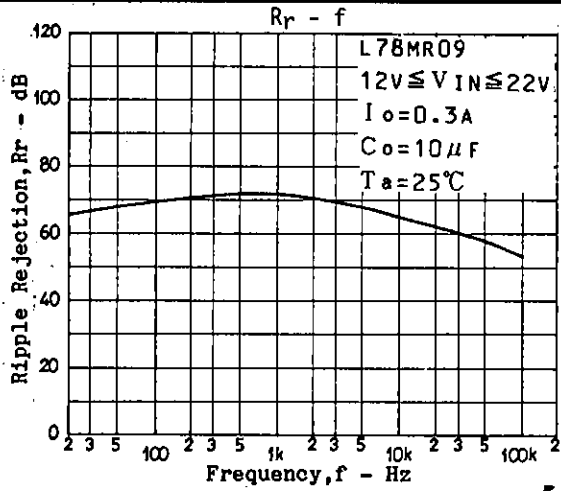

L78MR00 Series

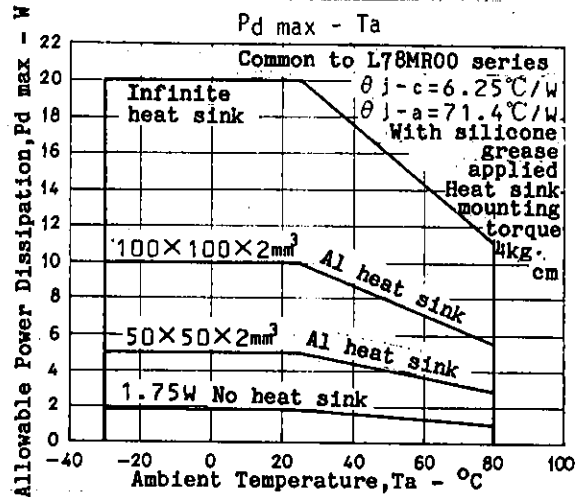
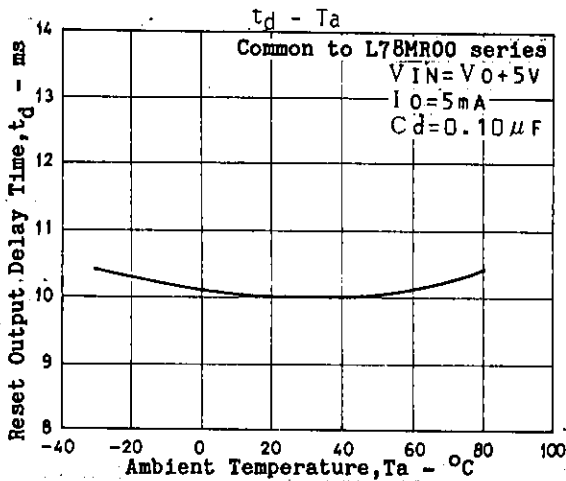
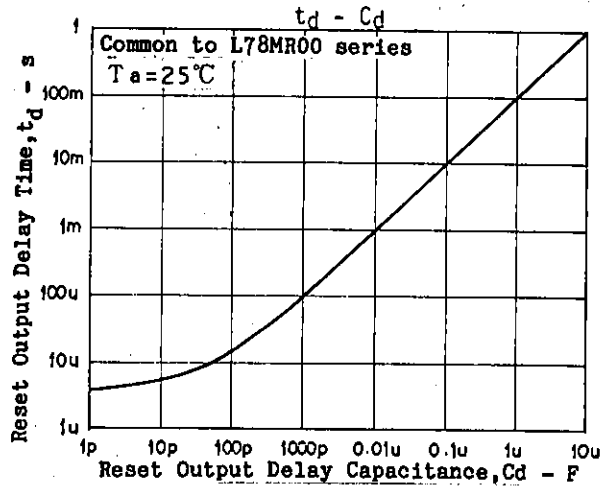
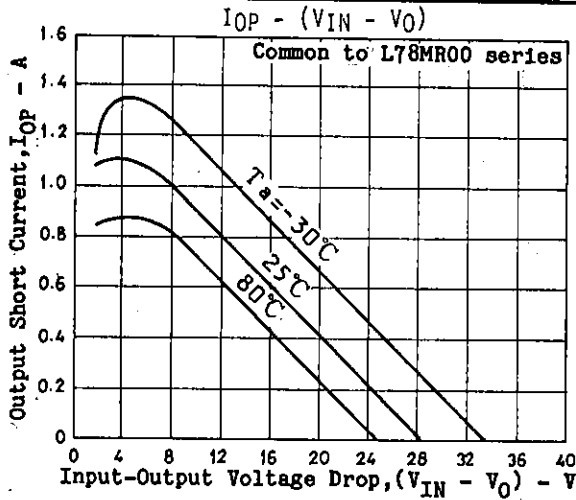

- No products described or contained herein are intended for use in surgical implants, life-support systems, aerospace equipment, nuclear power control systems, vehicles, disaster/crime-prevention equipment and the like, the failure of which may directly or indirectly cause injury, death or property loss.
- Anyone purchasing any products described or contained herein for an above-mentioned use shall:
 - ① Accept full responsibility and indemnify and defend SANYO ELECTRIC CO., LTD., its affiliates, subsidiaries and distributors and all their officers and employees, jointly and severally, against any and all claims and litigation and all damages, cost and expenses associated with such use;
 - ② Not impose any responsibility for any fault or negligence which may be cited in any such claim or litigation on SANYO ELECTRIC CO., LTD., its affiliates, subsidiaries and distributors or any of their officers and employees jointly or severally.
- Information (including circuit diagrams and circuit parameters) herein is for example only; it is not guaranteed for volume production. SANYO believes information herein is accurate and reliable, but no guarantees are made or implied regarding its use or any infringements of intellectual property rights or other rights of third parties.