

**LA6524****4-output Power Driver****Overview**

The LA6524 is a 4-output power driver developed for use in consumer and industrial equipment.

Functions

- Four buffer amp circuits on chip
- High output current (I_o max = 0.5 A)
- Includes current limiter
- Broad operating voltage range (± 2 to +12 V)
- Single power supply operation possible (4 to 24 V)
- Thermal shutdown circuit built-in.

Package Dimensions

unit : mm

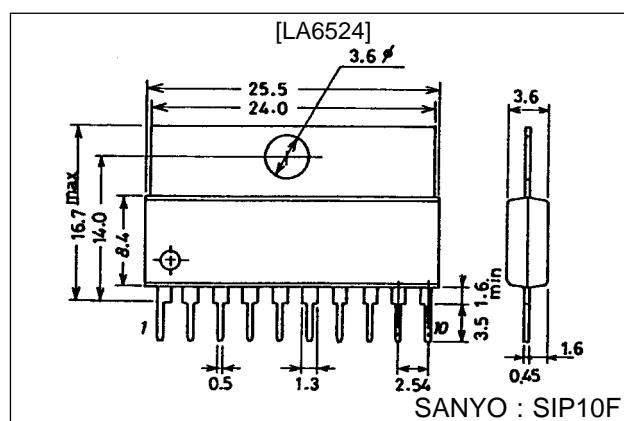
3046B-SIP10F**Specifications****Maximum Ratings at $T_a = 25\text{ }^\circ\text{C}$**

Parameter	Symbol	Conditions	Ratings	Unit
Maximum supply voltage	V_{CC}/V_{EE}		± 15	V
Input voltage	V_{IN}		± 14	V
Allowable power dissipation	P_d max	When using Al heat sink ($50 \times 50 \times 1.5 \text{ mm}^3$)	2.0	W
Operating temperature	T_{opr}		-20 to $+75$	$^\circ\text{C}$
Storage temperature	T_{stg}		-40 to $+125$	$^\circ\text{C}$

Operating Characteristics at $T_a = 25\text{ }^\circ\text{C}$, $V_{CC}/V_{EE} = \pm 10\text{ V}$

Parameter	Symbol	Conditions	min	typ	max	Unit
Current drain with no load	I_{CC}			10	30	mA
Input offset voltage	V_{IO}	$R_S \leq 10 \text{ k}\Omega$		2	7	mV
Input bias current	I_B			50	500	nA
Input voltage range	V_{ID}		-9		$+8$	V
Maximum output voltage	V_O	$R_L = 33 \Omega$		± 8		V
Slew rate	SR	$R_L = 33 \Omega$, $R_1 = 2.2 \Omega$, $C_1 = 0.1 \mu\text{F}$		0.15		V/ μs
Limiter current (built-in type)	I_{SC}			0.5		A

LA6524

Pin Assignments

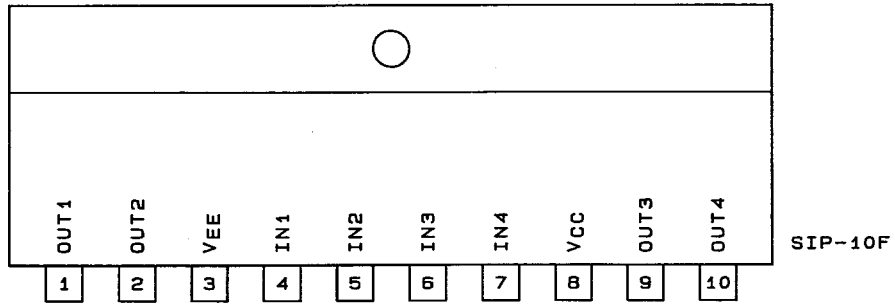

A03203

Block Diagram

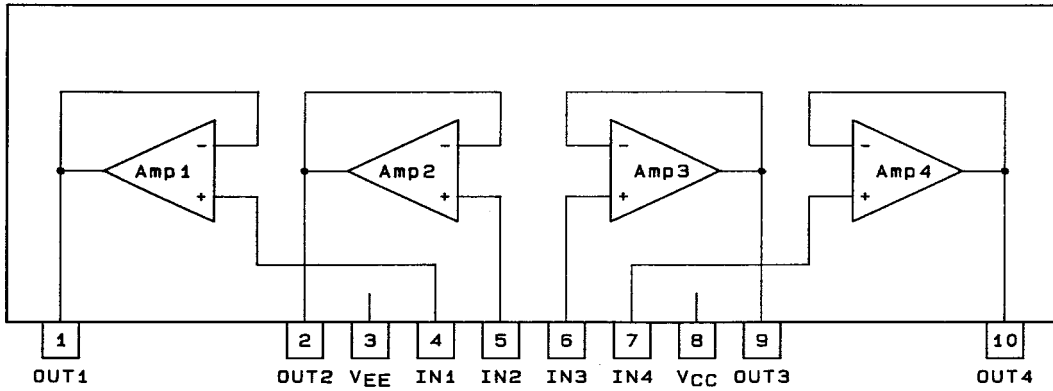

A03204

Sample Application Circuit

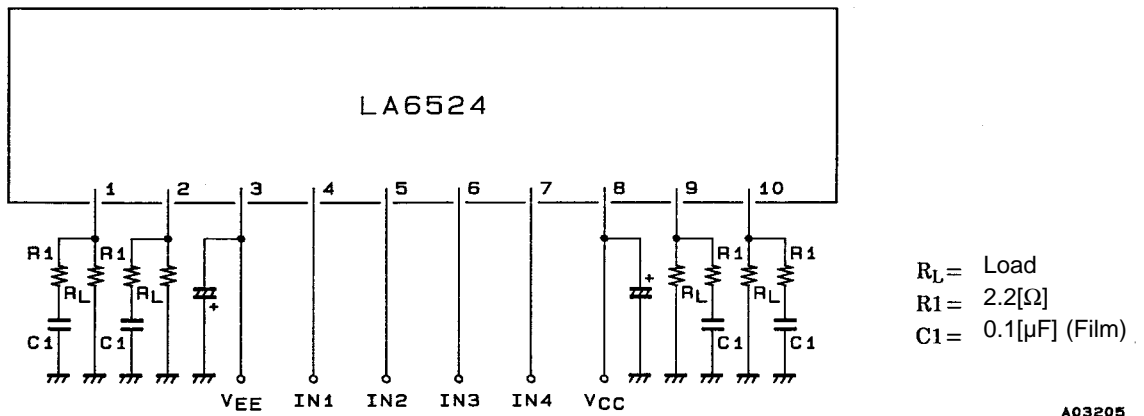

A03205

Test Circuit

1. I_{CC}

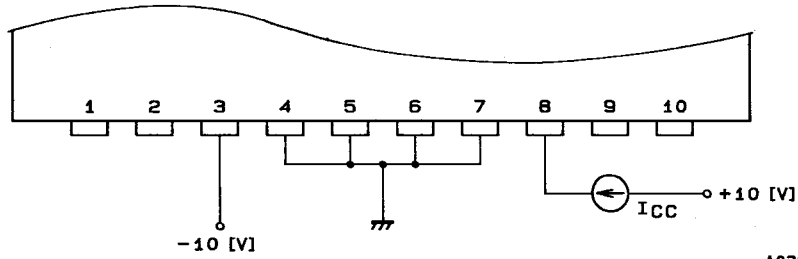

A03684

2. V_{IO}

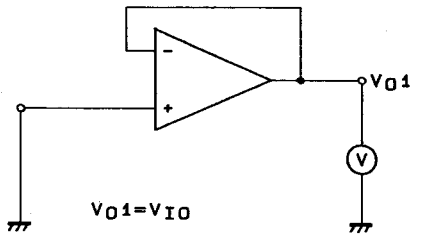

A03685

3. I_B

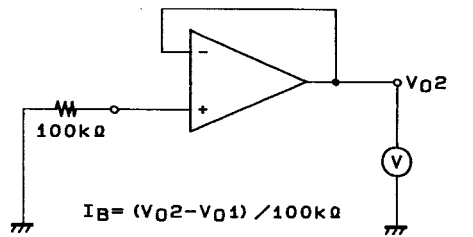

A03686

4. V_{ID}

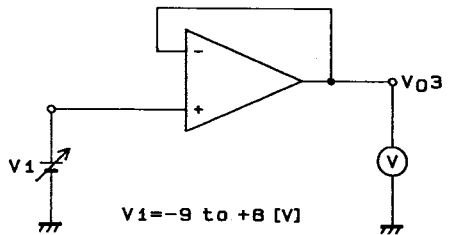

A03687

5. V_O, I_{SC}

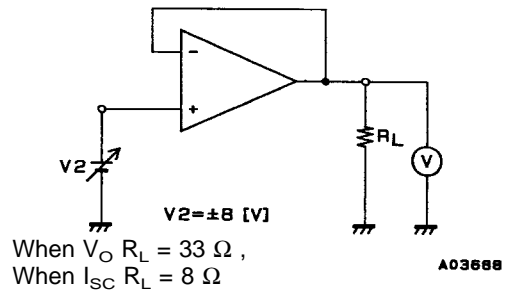

A03688

6. $S_{R}^{P_i}$

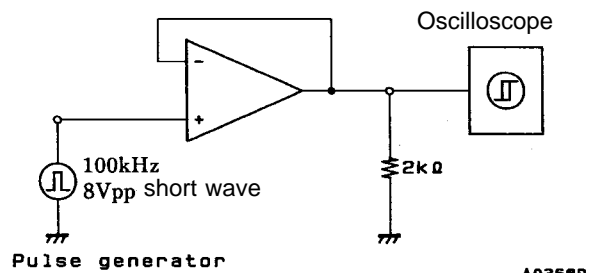

A03689

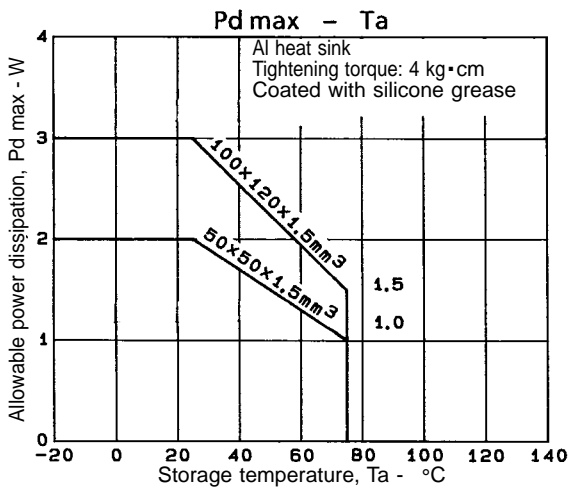

A03682

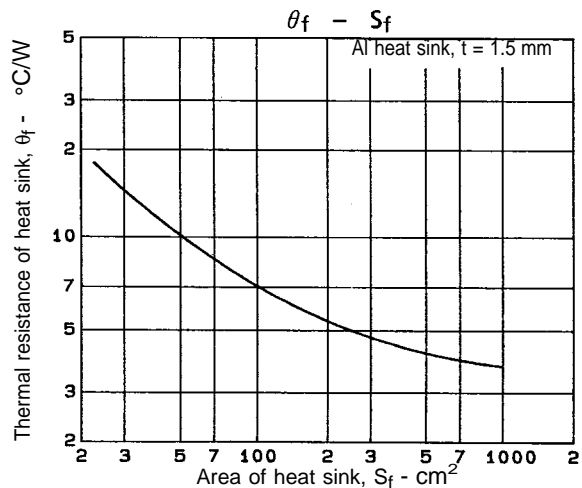

A03683

- No products described or contained herein are intended for use in surgical implants, life-support systems, aerospace equipment, nuclear power control systems, vehicles, disaster/crime-prevention equipment and the like, the failure of which may directly or indirectly cause injury, death or property loss.
- Anyone purchasing any products described or contained herein for an above-mentioned use shall:
 - ① Accept full responsibility and indemnify and defend SANYO ELECTRIC CO., LTD., its affiliates, subsidiaries and distributors and all their officers and employees, jointly and severally, against any and all claims and litigation and all damages, cost and expenses associated with such use:
 - ② Not impose any responsibility for any fault or negligence which may be cited in any such claim or litigation on SANYO ELECTRIC CO., LTD., its affiliates, subsidiaries and distributors or any of their officers and employees jointly or severally.
- Information (including circuit diagrams and circuit parameters) herein is for example only; it is not guaranteed for volume production. SANYO believes information herein is accurate and reliable, but no guarantees are made or implied regarding its use or any infringements of intellectual property rights or other rights of third parties.

This catalog provides information as of May, 1995. Specifications and information herein are subject to change without notice.