

SANYO

No.1415C

**LA5000M Series**

Monolithic Linear IC

2 to 10V 60mA
Low Saturation Voltage Regulators

The LA5002M, 5003M, 5004M, 5005M, 5006M, 5008M, 5009M, 5010M are voltage regulators having a small input-output voltage drop (0.2V typ.). They are especially suited for use in battery-powered low voltage equipment and commercial or industrial equipment having a large voltage regulation.

Features

- . Small input-output voltage drop ($0.2V/I_{OUT}=20mA$ typ.)
- . Minimum number of external parts required
- . Highly resistant against load short
- . Radio noise (radiation) control pin

Maximum Ratings at $T_a=25^\circ C$

			unit
Input Supply Voltage	V_{INmax} LA5002M, 5003M, 5004M, 5005M	12	V
	LA5006M, 5008M, 5009M, 5010M	16	V
Output Current	I_{OUTmax}	60	mA
Allowable Power Dissipation	P_dmax	300	mW
Operating Temperature	T_{opg}	-20 to +80	$^\circ C$
Storage Temperature	T_{stg}	-30 to +125	$^\circ C$

Operating Characteristics at $T_a=25^\circ C, C_{OUT}=10\mu F, I_{OUT}=20mA, V_{IN}=3V$ [LA5002M], $V_{IN}=4V$ [LA5003M], $V_{IN}=5V$ [LA5004M], $V_{IN}=6V$ [LA5005M], $V_{IN}=7V$ [LA5006M], $V_{IN}=9V$ [LA5008M], $V_{IN}=10V$ [LA5009M], $V_{IN}=11V$ [LA5010M]

		min	typ	max	unit
Output Voltage	V_o LA5002M	1.85	2.0	2.15	V
	LA5003M	2.8	3.0	3.2	V
	LA5004M	3.75	4.0	4.25	V
	LA5005M	4.75	5.0	5.25	V
	LA5006M	5.7	6.0	6.3	V
	LA5008M	7.6	8.0	8.4	V
	LA5009M	8.55	9.0	9.45	V
	LA5010M	9.4	10.0	10.6	V
Line Regulation	V_o line LA5002M $2.5V < V_{IN} < 8V$			50	mV
	LA5003M $3.5V < V_{IN} < 9V$			50	mV
	LA5004M $4.5V < V_{IN} < 10V$			50	mV
	LA5005M $5.5V < V_{IN} < 11V$			50	mV

Continued on next page.

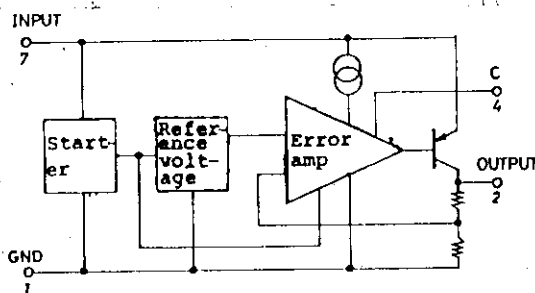
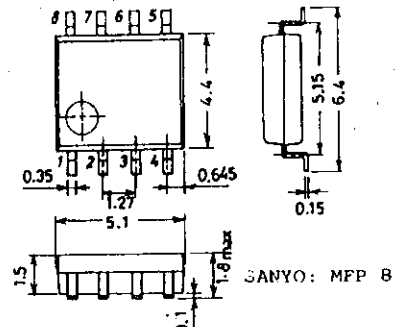
Equivalent Circuit Block Diagram**Case Outline 3032B-M8IC**
(unit:mm)

Specifications and information herein are subject to change without notice.

SANYO Electric Co., Ltd. Semiconductor Overseas Marketing Div.
Natsume Bldg., 18-6, 2-chome, Yushima, Bunkyo-ku, TOKYO 113 JAPAN

8119YT/8287KI/2126KI/D013KI, TS No. 1415-1/6

LA5000M Series

Continued from preceding page.

			min	typ	max	unit
Line Regulation		LA5006M $6.5V < V_{IN} < 12V$			50	mV
		LA5008M $9V < V_{IN} < 14V$			50	mV
		LA5009M $10V < V_{IN} < 15V$			50	mV
		LA5010M $11V < V_{IN} < 16V$			50	mV
Load Regulation	V_o load	$1mA < I_{OUT} < 40mA$			20	mV
		$1mA < I_{OUT} < 50mA$			25	mV
Quiescent Current Dissipation	I_{CCO}	LA5002M	1.2	2.0		mA
		LA5003M	1.4	2.0		mA
		LA5004M	1.5	2.3		mA
		LA5005M, 5006M, 5008M, 5009M, 5010M	1.7	2.5		mA
Ripple Rejection	R_r	LA5002M, 5004M, 5005M $f=120Hz$	40			dB
		LA5003M $f=120Hz$	43			dB
		LA5006M, 5008M, 5009M, 5010M $f=120Hz$	35			dB
Input-Output Voltage Drop	V_{drop}		0.2	0.3		V
Temperature Coefficient of Output Voltage	$k\Delta v_o/\Delta T$	LA5002M, 5003M, 5004M, 5005M	-1			1 mV/°C
		LA5006M	-2			2 mV/°C
		LA5008M	-3			3 mV/°C
		LA5009M	-4			4 mV/°C
		LA5010M	-5			5 mV/°C
Output Noise Voltage	V_N	$10Hz < f < 100kHz$		30		μV

Sample Application Circuit

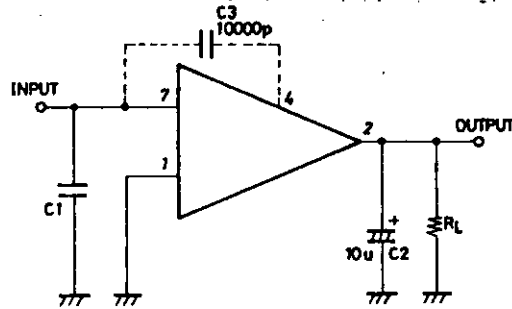

Note: Capacitor C3 is not required unless radio noise is a problem.

Test Circuits

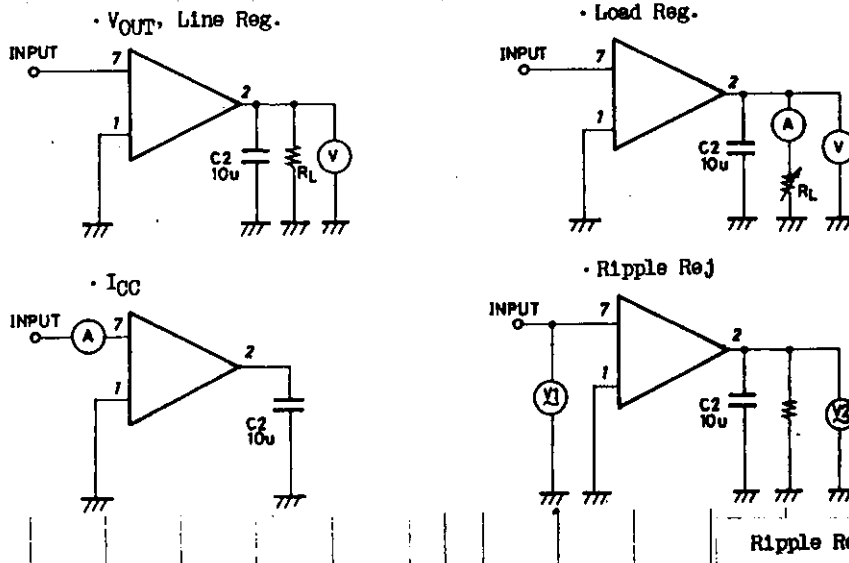

LA5000M Series

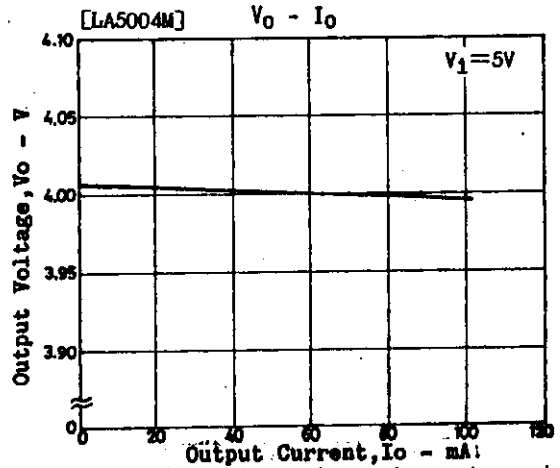
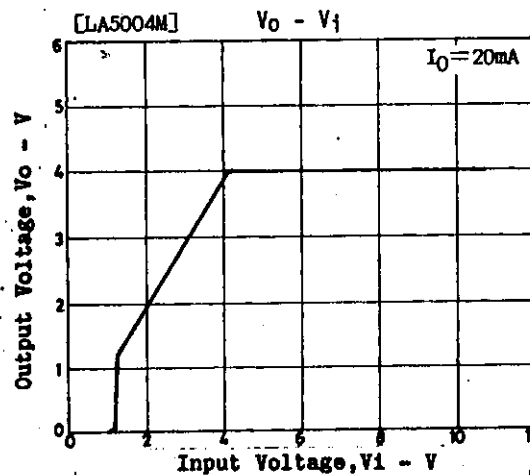
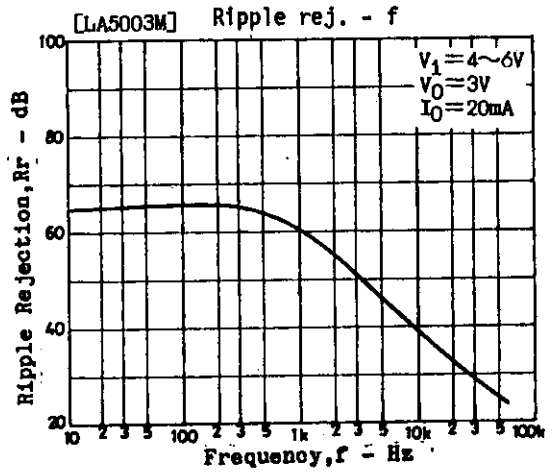
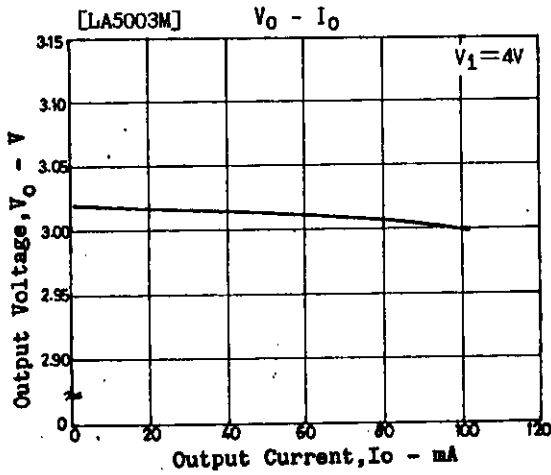
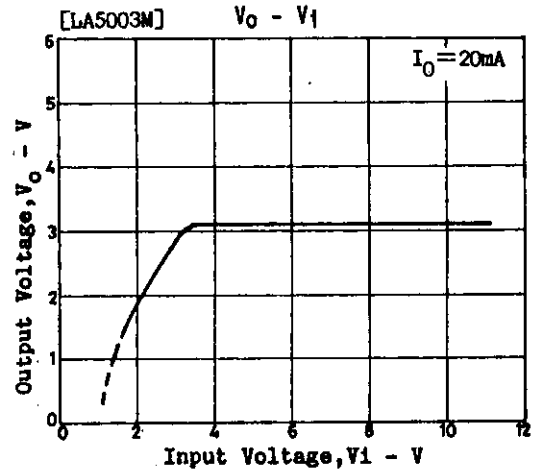
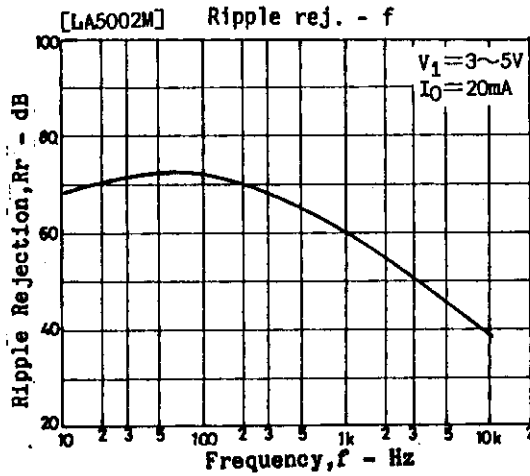
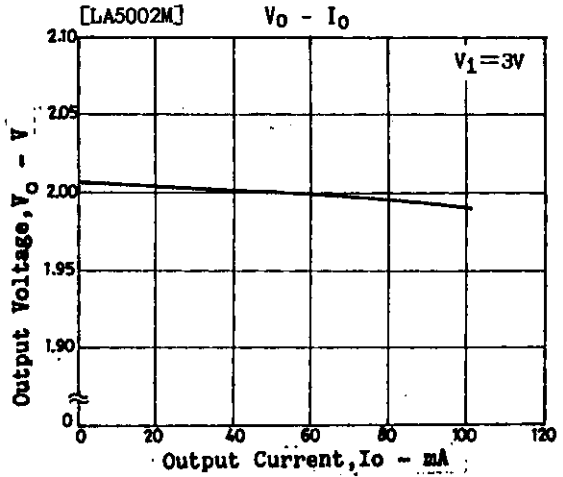
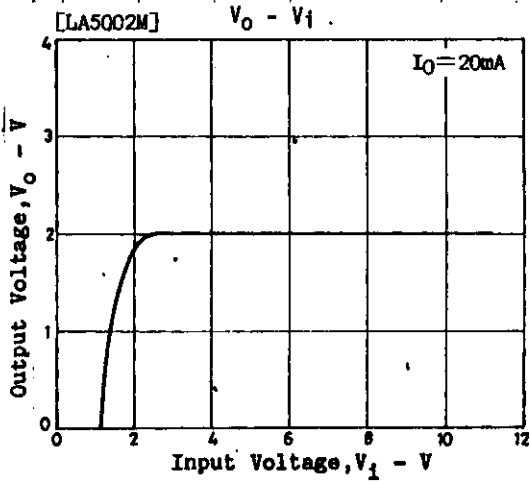

LA5000M Series

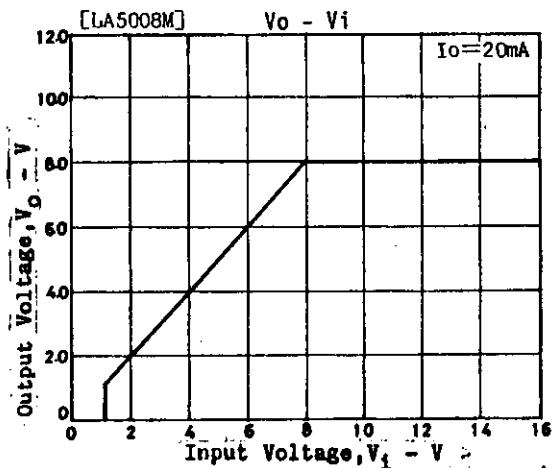
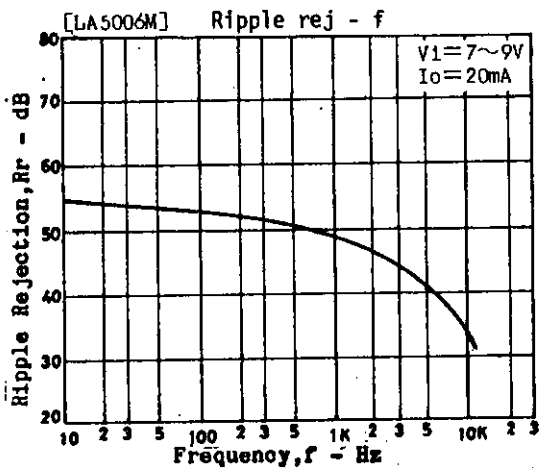
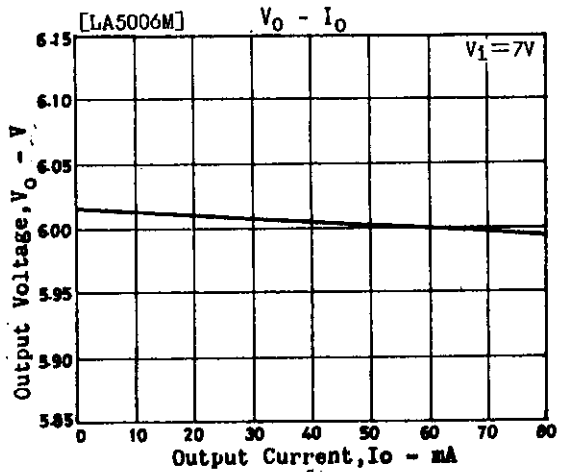
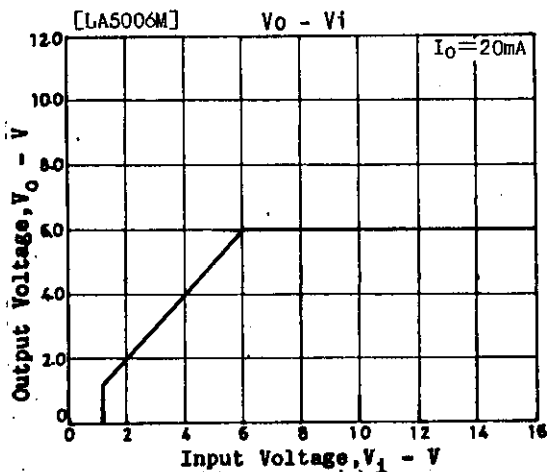
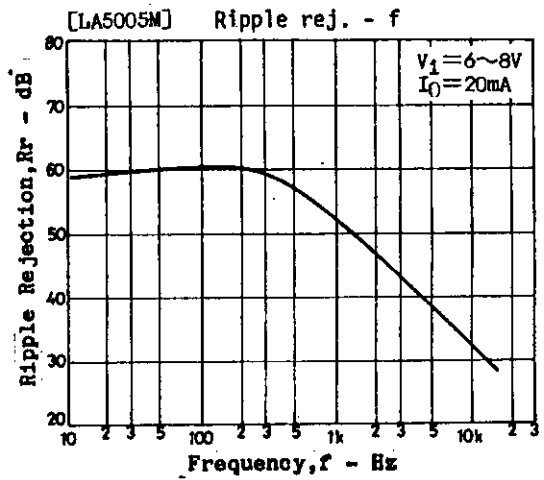
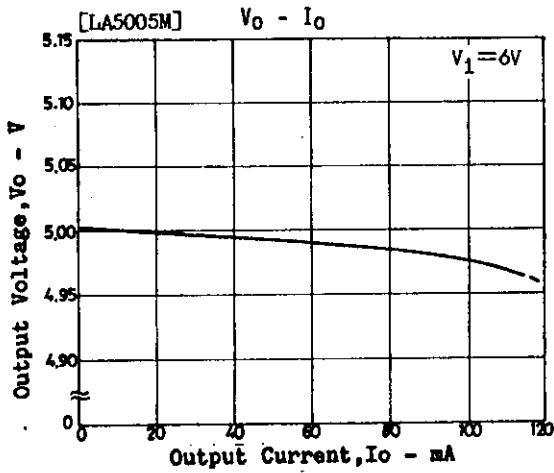
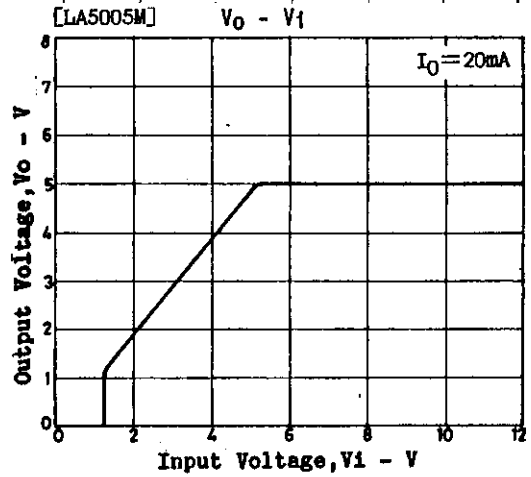
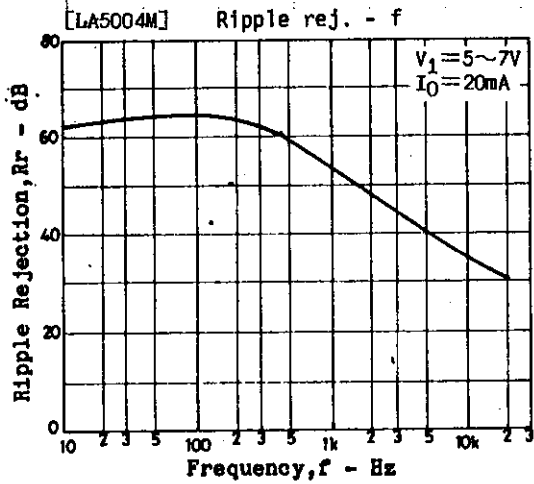

LA5000M Series

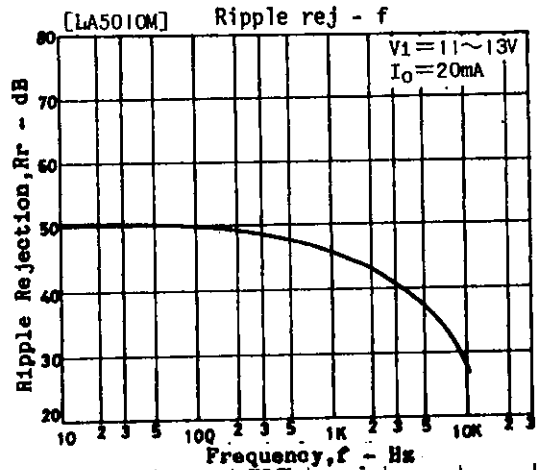
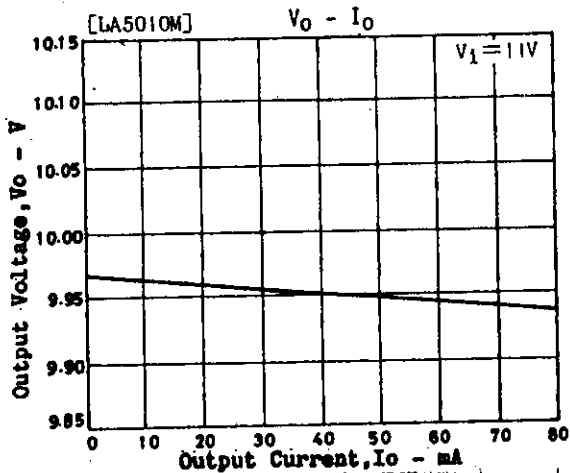
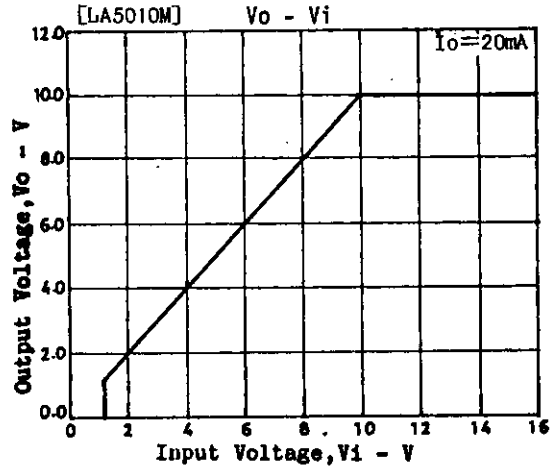
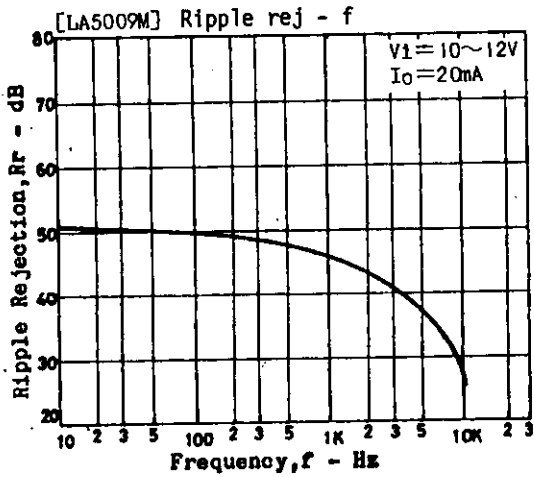
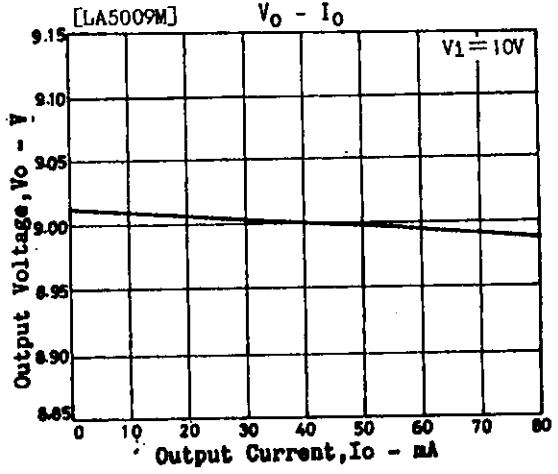
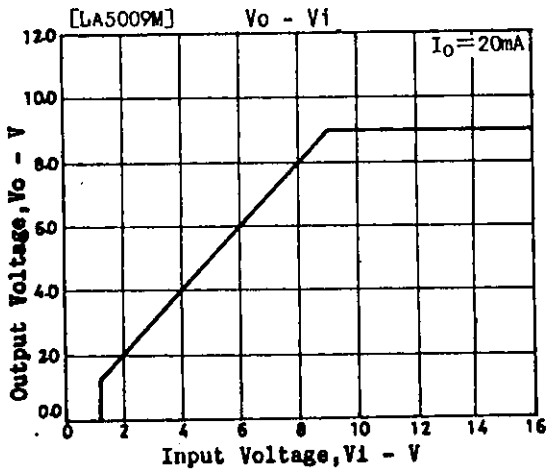
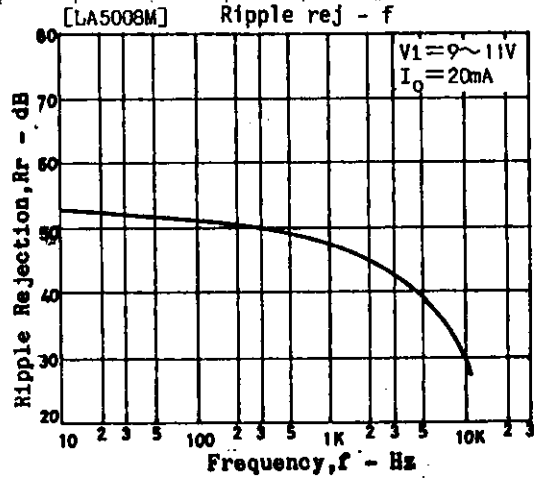
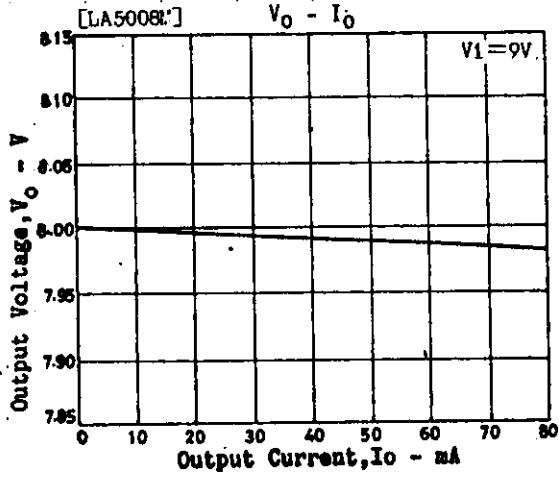

LA5000M Series

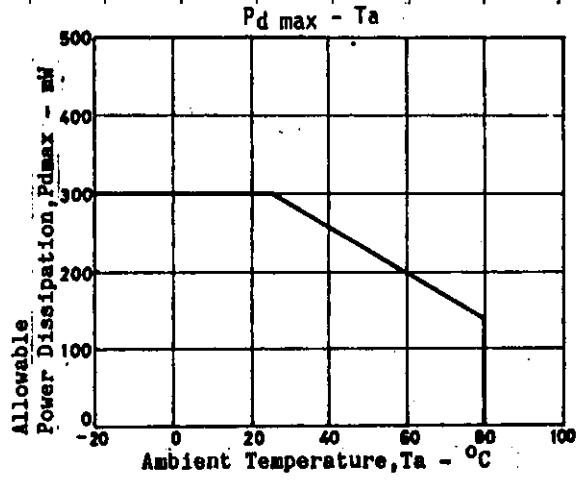
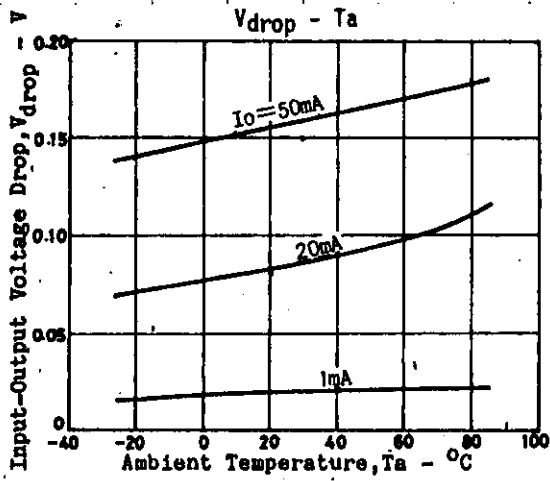

The application circuit diagrams and circuit constants herein are included as an example and provide no guarantee for designing equipment to be mass-produced.
 The information herein is believed to be accurate and reliable. However, no responsibility is assumed by SANYO for its use; nor for any infringements of patents or other rights of third parties which may result from its use.