



# LA4165M

## Recording/Playback IC for Micro-Cassette Tape Recorder

### Overview

The LA4165M Recording-Playback IC combines the functions required to design the recording and playback systems and motor control circuits for micro- or standard-cassette tape recorders into a single chip.

Functions provided include automatic audio input sensing during recording with stepless setting of the on-off threshold using the playback volume control, and LED indication that recording is in progress.

Recording and playback modes can be toggled using a single control pin.

The LA4165M also has an on-chip preamp, power amp and ALC circuits, and has been designed to operate with a 3V power supply. The device is available in 24-pin plastic MFPs.

### Features

- Audio input sensor circuit
- LED driver circuit
- Motor control circuit
- ALC circuit
- Preamp and power amp circuits

### Package Dimensions

unit: mm

#### 3108-MFP24D

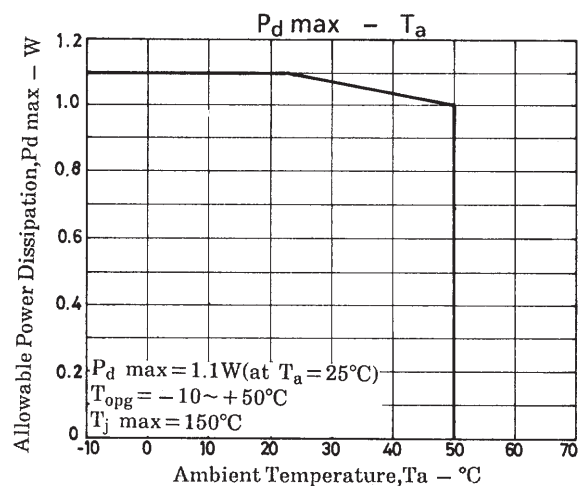
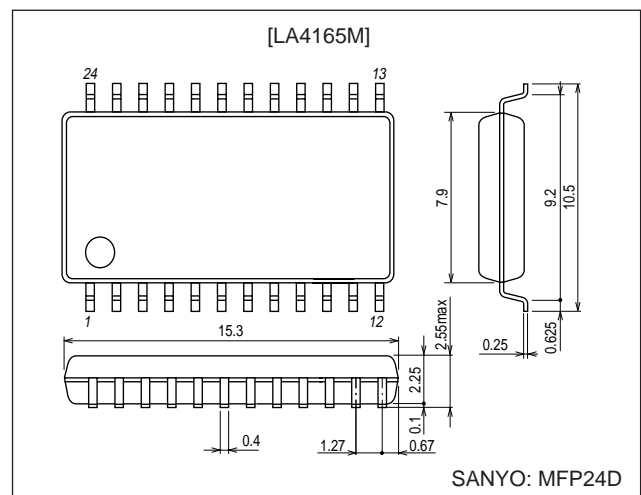

■ Any and all SANYO products described or contained herein do not have specifications that can handle applications that require extremely high levels of reliability, such as life-support systems, aircraft's control systems, or other applications whose failure can be reasonably expected to result in serious physical and/or material damage. Consult with your SANYO representative nearest you before using any SANYO products described or contained herein in such applications.

■ SANYO assumes no responsibility for equipment failures that result from using products at values that exceed, even momentarily, rated values (such as maximum ratings, operating condition ranges, or other parameters) listed in products specifications of any and all SANYO products described or contained herein.

**SANYO Electric Co., Ltd. Semiconductor Company**

TOKYO OFFICE Tokyo Bldg., 1-10, 1 Chome, Ueno, Taito-ku, TOKYO, 110-8534 JAPAN

## LA4165M

### Specifications

#### Maximum Ratings at $T_a = 25^\circ\text{C}$

| Parameter                   | Symbol        | Conditions              | Ratings     | Unit             |
|-----------------------------|---------------|-------------------------|-------------|------------------|
| Maximum Supply Voltage      | $V_{CC\ max}$ |                         | 4.5         | V                |
| Allowable Power Dissipation | $P_d\ max$    | $G_{VN} + \text{Power}$ | 1100        | mW               |
| Operating Temperature       | $T_{opr}$     |                         | -10 to +50  | $^\circ\text{C}$ |
| Storage Temperature         | $T_{stg}$     |                         | -55 to +150 | $^\circ\text{C}$ |

#### Operating Conditions at $T_a = 25^\circ\text{C}$

| Parameter                  | Symbol       | Conditions | Ratings    | Unit       |
|----------------------------|--------------|------------|------------|------------|
| Recommended Supply Voltage | $V_{CC}$     |            | 3.0        | V          |
| Operating Voltage Range    | $V_{CC\ op}$ |            | 1.8 to 3.6 | V          |
| Power Amp Load Resistance  | $R_L\ PWR$   | PLAY       | 4          | $\Omega$   |
|                            |              | REC        | 10         | k $\Omega$ |
| Preamp Load Resistance     | $R_L\ PRE$   |            | 10         | k $\Omega$ |

#### Operating Characteristics at $T_a = 25^\circ\text{C}$ , $V_{CC} = 3.0\text{ V}$ , $R_L = 4\ \Omega$ (Play Power), $R_L = 10\ \text{k}\Omega$ (Rec Power), $R_L = 10\ \text{k}\Omega$ (Pre), $f = 1\ \text{kHz}$ , $0\ \text{dBm} = 0.775\ \text{V}$

| Parameter                        | Symbol        | Conditions  | Ratings |       |       | Unit          |
|----------------------------------|---------------|---|---------|-------|-------|---------------|
|                                  |               |   | min     | typ   | max   |               |
| <b>[Pre + Power]</b>             |               |   |         |       |       |               |
| Quiescent Current                | $I_{CC-R}$    | REC mode, $V_i = 0\ \text{V}$   | 12      | 25    | 38    | mA            |
| Quiescent Current                | $I_{CC-P}$    | PLAY mode, $V_i = 0\ \text{V}$  | 13      | 26    | 39    | mA            |
| Voltage Gain (Closed Loop) REC   | $V_{GTR}$     | REC mode, $V_O = -5\ \text{dBm}$  | 62      | 64.5  | 67    | dB            |
| Voltage Gain (Closed Loop) PLAY  | $V_{GTP}$     | PLAY mode, $V_O = -5\ \text{dBm}$                                       | 71      | 73.5  | 76    | dB            |
| <b>[Pre Amp]</b>                 |               |   |         |       |       |               |
| Voltage Gain (Closed Loop) REC   | $V_{G1\ R}$   | REC mode, $V_O = -10\ \text{dBm}$ , $R_{NF} = 100\ \Omega$              | 32.5    | 35    | 37.5  | dB            |
| Voltage Gain (Closed Loop) PLAY  | $V_{G1\ P}$   | PLAY mode, $V_O = -10\ \text{dBm}$ , $R_{NF} = 100\ \Omega$             | 42.5    | 45    | 47.5  | dB            |
| Maximum Output Voltage           | $V_O\ max$    | THD=1%, PLAY mode   | 0.3     | 0.6   | 1.0   | V             |
| Equivalent Input Noise Voltage   | $V_{NI}$      | PLAY mode, BPF = 20 Hz to 20 kHz  | 0.5     | 1.1   | 2.0   | $\mu\text{V}$ |
| Input Resistance                 | $R_I$         |   | 22.5    | 32.2  | 42    | k $\Omega$    |
| Total Harmonic Distortion        | THD1          | PLAY mode, $V_O = 0.4\ \text{V}$  | 0.01    | 0.11  | 1.0   | %             |
| <b>[POWER AMP]</b>               |               |   |         |       |       |               |
| Voltage Gain                     | $V_{G2}$      | $V_O = -5\ \text{dBm}$ , $R_L = 4\ \Omega$                              | 26.0    | 28.5  | 31.0  | dB            |
| Output Power                     | $P_O$         | THD = 10 %, $R_L = 4\ \Omega$   | 180     | 215   | 350   | mW            |
| Total Harmonic Distortion        | THD2          | $P_O = 30\ \text{mW}$ , $R_L = 4\ \Omega$                               | 0.05    | 0.5   | 1.5   | %             |
| Output Noise Voltage             | $V_{NO}$      | $R_V = 0$ , $R_L = 4\ \Omega$ , BPF = 20 Hz to 20 kHz                   | 5       | 25    | 100   | $\mu\text{V}$ |
| <b>[ALC]</b>                     |               |   |         |       |       |               |
| ALC Width                        | ALC W         | Input voltage above ALC cut-in voltage for ALC output to rise by 2.5 dB | 30      | 38    | 45    | dB            |
| ALC Distortion                   | ALC THD       | Pre: $V_i = -40\ \text{dBm}$  | 0.1     | 0.67  | 1.5   | %             |
| ALC Output                       | ALC $V_O$     | Pre: $V_i = -40\ \text{dBm}$  | 0.35    | 0.46  | 0.55  | V             |
| ALC Start Input Level            | ALC $V_{IN}$  |   | -66.5   | -69   | -71.5 | dBm           |
| <b>[Voice Sensor]</b>            |               |   |         |       |       |               |
| Minimum Activation Input Voltage | $V_{OP\ min}$ | VR (10 k $\Omega$ ) max   | -84.5   | -81.5 | -78.5 | dBm           |
| Maximum Activation Input Voltage | $V_{OP\ max}$ | VR (10 k $\Omega$ ) max   | -62.5   | -59.5 | -56.5 | dBm           |
| Input Hysteresis                 | $V_{O\ HL}$   |   | 3       | 6     | 9     | dB            |
| <b>[LED Drive]</b>               |               |   |         |       |       |               |
| LED Drive Current                | $I_{LED}$     | Red LED   | 1.0     | 2.5   | 4.5   | mA            |

Continued on next page.

## LA4165M

Continued from preceding page.

| Parameter                                   | Symbol   | Conditions  | Ratings |        |       | Unit |
|---|--|---|---------|--------|-------|------|
|   |  |   | min     | typ    | max   |      |
| [Moter Control]                             |  |   |         |        |       |      |
| Reference voltage                           | $V_{ref}$  | $I_m = 100 \text{ mA}$  | 1.1     | 1.25   | 1.4   | V    |
| Quiescent Current                           | $I_d$  | $I_m = 100 \text{ mA}$  | 2.0     | 3.0    | 6.0   | mA   |
| Shunt Ratio                                 | K  | $I_m = 50\text{--}100 \text{ mA}$   | 45      | 50     | 55    |      |
| Residual Voltage                            | $V_{sat}$  | $I_m = 200 \text{ mA}, V_{ref} = V_{cont}$                                | 0.1     | 0.3    | 0.5   | V    |
| Voltage Characteristic of Reference Voltage | $\frac{\Delta V_{ref}}{V_{ref}} / \Delta V_{CC}$ | $V_{CC} = 1.8 \text{ to } 4.5 \text{ V}, I_m = 100 \text{ mA}$            | 0       | 0.1    | 0.5   | %/V  |
| Voltage Characteristic of Shunt Ratio       | $\frac{\Delta K}{K} / \Delta V_{CC}$             | $V_{CC} = 2.0 \text{ to } 4.5 \text{ V}, I_m = 50\text{--}100 \text{ mA}$ | 0       | 0.1    | 0.5   | %/V  |
| Current Characteristic of Reference Voltage | $\frac{\Delta V_{ref}}{V_{ref}} / \Delta I_m$    | $I_m = 50 \text{ to } 200 \text{ mA}$                                     | 0       | 0.007  | 0.03  | %/mA |
| Current Characteristic of Shunt Ratio       | $\frac{\Delta K}{K} / \Delta I_m$                | $I_m = 50\text{--}100 \text{ mA to } 150\text{--}200 \text{ mA}$          | -0.05   | +0.005 | +0.05 | %/mA |

### Recording/Playback Mode Functions

○ : ON    × : OFF

| Circuit        | Preamp         | ALC Circuit | LED Drive | Voice Sensor Circuit | Power Amp | Motor Control |
|----------------|----------------|-------------|-----------|----------------------|-----------|---------------|
| Recording Mode | (MIC Amp)<br>○ | ○           | ○ ※       | ○ ※                  | ○         | ○ ※           |
| Playback Mode  | (EQ Amp)<br>○  | ×           | ×         | ×                    | ○         | ○             |

※ : Block is on when MIC input voltage exceeds the threshold level.

# LA4165M

## Test Circuit

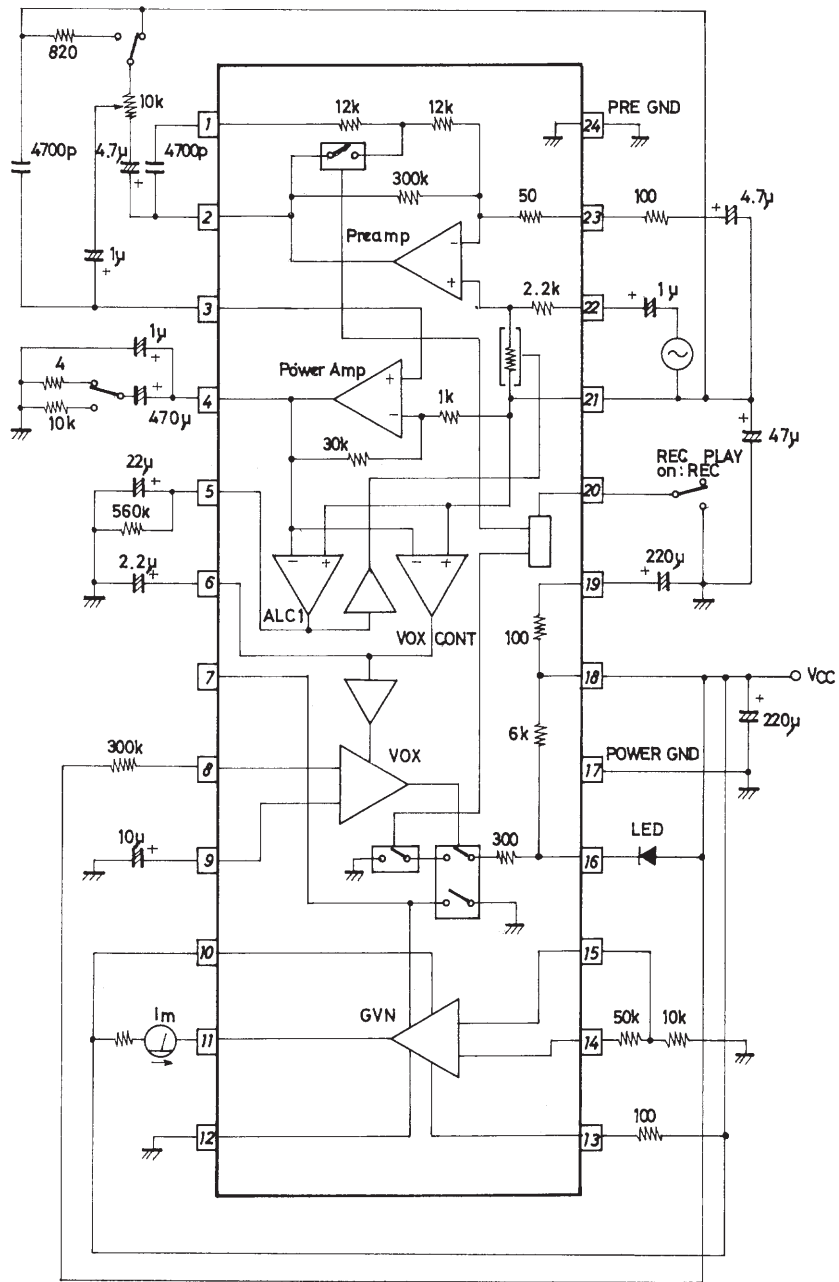

Unit (resistance:  $\Omega$ , capacitance: F)

Equivalent Circuit

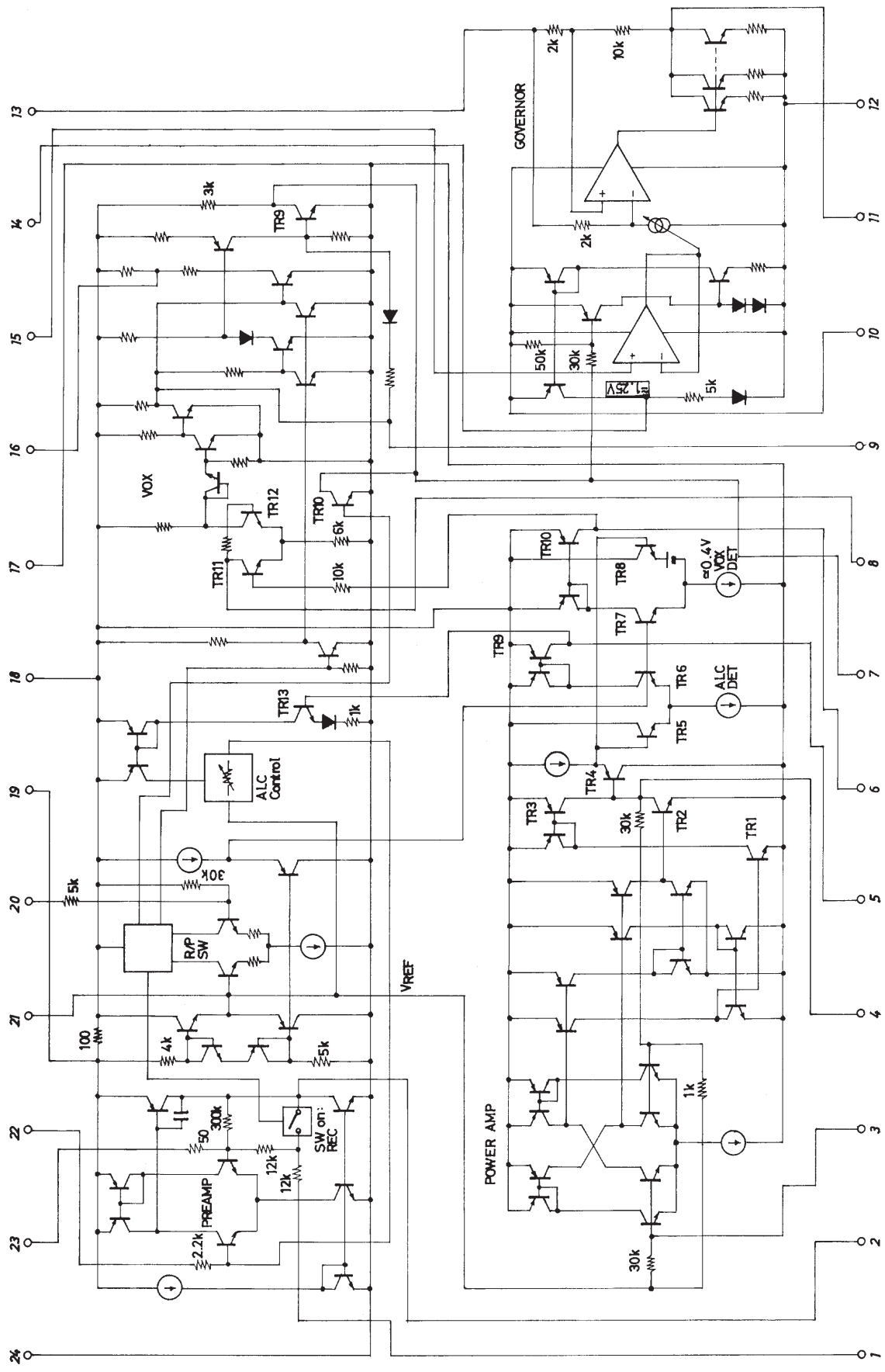

Unit (resistance: Ω)

# LA4165M

## Block Diagram

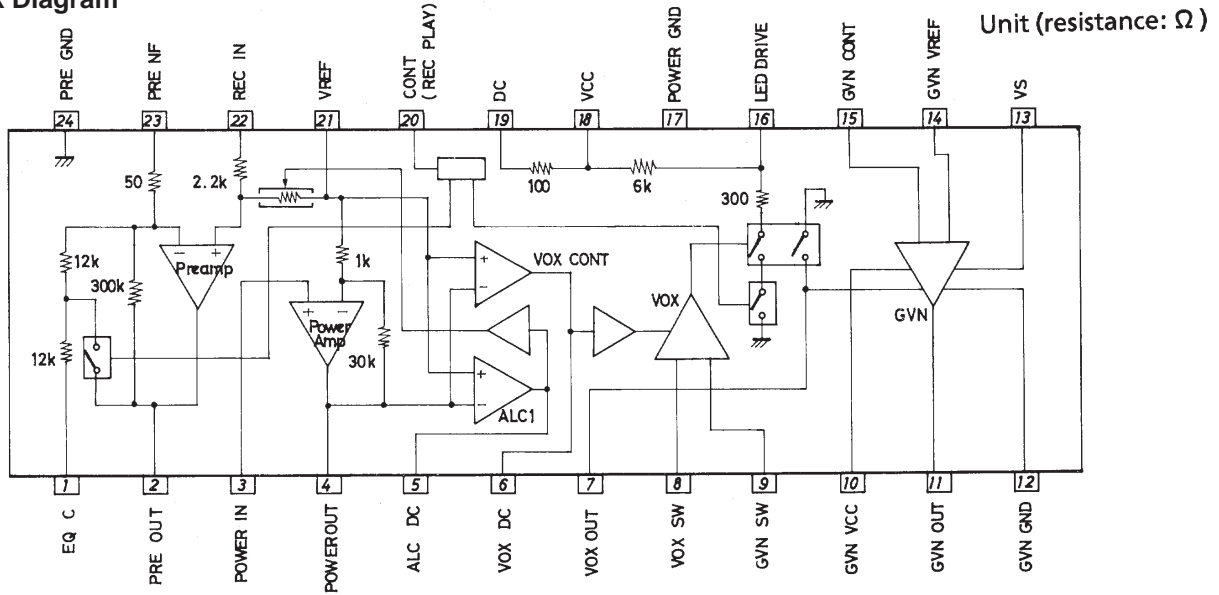

## Sample Application Circuit

Voice sensor activation level set. As R2 is reduced, the voice sensor circuit activates at a low input voltage.

Unit (resistance:  $\Omega$ , capacitance: F)

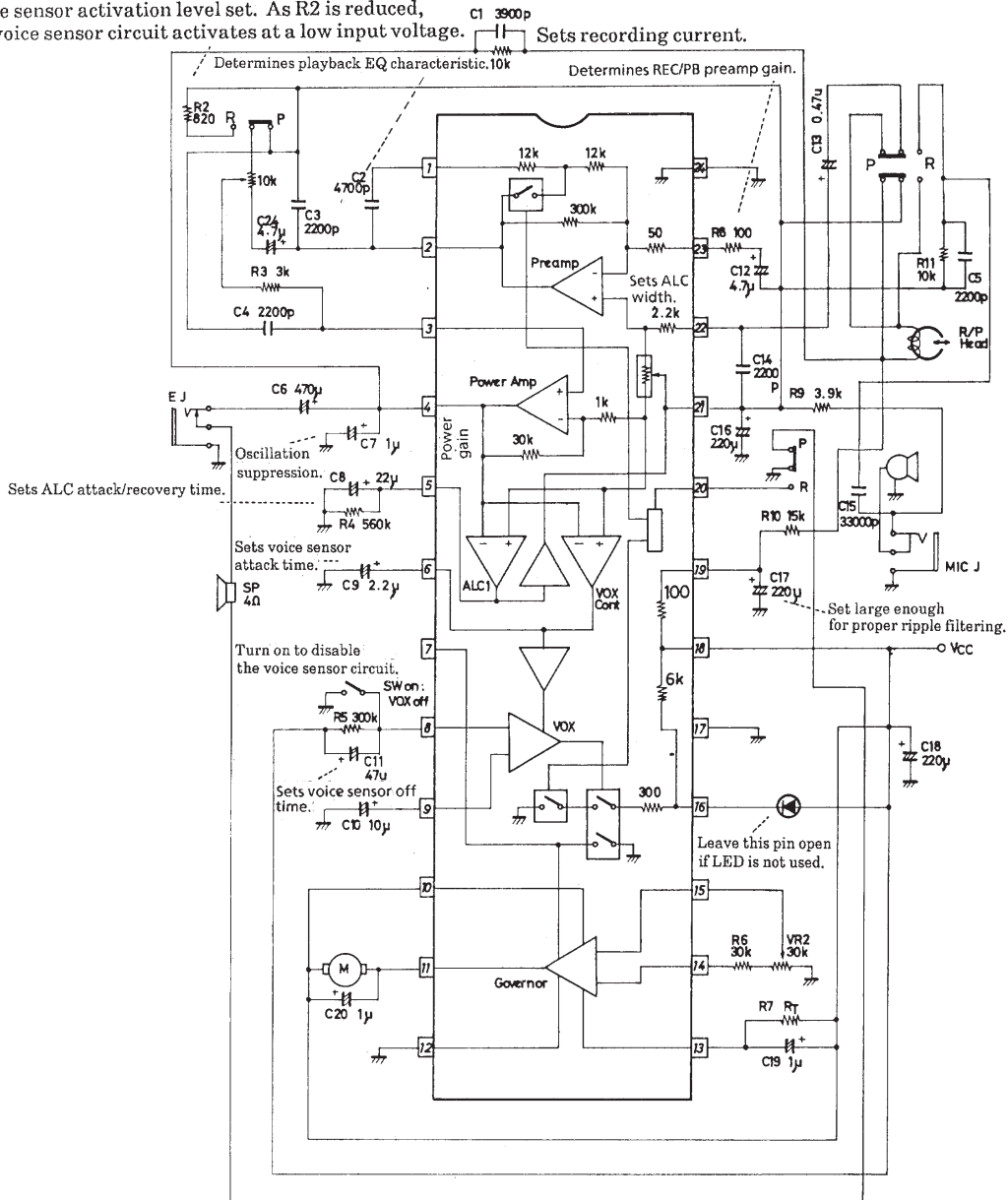

---

## Functional Description

### [Preamp]

- The frequency response characteristic of the low noise preamplifier is selected by the record/playback select pin CONT (pin 20). If CONT is taken to ground to select record mode, the frequency response is flat. If CONT is left open, playback mode is selected and the preamp has the NAM response curve.

### [Power Amp]

- The power amplifier is suited to driving 4  $\Omega$  speakers and earphones.

### [ALC]

- The ALC (Automatic Level Control) circuit is active in recording mode. It detects the power amp output level, and controls the preamplifier input gain so that the power amp output level is constant.

### [VOX CONT VOX]

- This circuit monitors the power amp output level, and turns the motor drive on or off. When the VOX CONT circuit is operating, the LED drive output on pin 16 is active. The LED is extinguished if the supply voltage drops to 1.8V.

### [GVN]

- Motor control circuit. The external constants are determined according to the motor characteristics to keep the motor speed constant.

## Circuit Components

The function of each component, together with recommended values in parentheses, are listed below.

- C1: (2200 to 4700 pF)  
Determines the frequency response of the signal voltage to the record/replay head during recording. Its value should be selected according to the characteristics of the head.
- C2 : (4700 pF)  
Determines the playback equalization frequency response.
- C3 : (2200 pF)  
Suppresses high-frequency oscillation.
- C4 : (2200 to 4700 pF)  
Controls high-frequency characteristics. C4 will interact with R3 to reduce the power amp input level if it is too large.
- C5 : (2200 to 4700 pF)  
Microphone input high-frequency filter. This should be selected according to the high-frequency cut-off and the value of C21.
- C6 : (470  $\mu$ F)  
Couples the power amp output to the speaker or headphones. A value of 220  $\mu$ F is adequate when using an 8  $\Omega$  speaker or headphones.
- C7 : (1  $\mu$ F)  
Suppresses oscillation. For low-temperature operation (down to  $-10^{\circ}\text{C}$ ), a 0.47  $\mu$ F tantalum electrolytic capacitor should be used.
- C8 : (22  $\mu$ F)  
ALC control smoothing filter. C8 should not be too large, since this will also increase attack time.
- C9 : (0.1 to 2.2  $\mu$ F)  
Voice sensor (VOX) control smoothing filter. C8 should not be too large, since this will also increase turn-on delay (the time for the motor drive circuit to turn on after the microphone input voltage reaches the set level).

Continued on next page.

Continued from preceding page.

- C10 : (10  $\mu$ F)  
Voice sensor transient suppression. This prevents the motor drive from being turned on by large transient pulses.
- C11 : (47  $\mu$ F)  
Determines the time constant for motor drive hold after the voice sensor circuit turns off. The motor drive remains on for approximately 4 to 5 seconds if the resistor in parallel with R5 is 300 k $\Omega$ .
- C12 : (4.7  $\mu$ F)  
Together with series resistor R8, determines the preamp low-frequency cut-off. For C12 =4.7  $\mu$ F and R8=100  $\Omega$ , the cut-off is approximately 200 Hz. The cut-off can be set to approximately 100 or 300 Hz by giving C12 a value of 10  $\mu$ F or 2.2  $\mu$ F, respectively.
- C13 : (0.47  $\mu$ F)  
Preamp input coupling capacitor.
- C14 : (2200  $\mu$ pF)  
EMI suppression capacitor. Select this according to the characteristics of the record/play head.
- C15 : (3300 pF)  
Microphone input high-frequency filter.
- C16 : (220  $\mu$ F)  
Reference voltage decoupling capacitor.
- C17 : (220  $\mu$ F)  
Head DC supply ripple filter.
- C18 : (220  $\mu$ F)  
Supply decoupling capacitor.
- C19 : (1 to 10  $\mu$ F)  
Reference resistor (R7) bypass capacitor. Setting should be performed according to motor characteristics.
- C20 : (1  $\mu$ F)  
Load (motor) bypass capacitor. Setting should be performed according to motor characteristics.
- R1 : (5 to 15 k $\Omega$ )  
Determines the flow of AC current through the head. Select this according to the head characteristics and ALC level.
- R2 : (820  $\Omega$ )  
Determines the microphone input level at which the voice sensor starts operating when VR1 is at minimum. Larger values for R2 give voice sensor operation at lower microphone input signal levels.
- R3 : (3 k $\Omega$ )  
Improves high-frequency response and reduces high-frequency distortion. Distortion above 5 kHz increases as R3 decreases.
- R4 : (100 k $\Omega$  to 3 M $\Omega$ )  
Determines ALC recovery time.
- R5 : (300 k $\Omega$ )  
Voice sensor circuit control current resistor. R5 and C11 form the motor drive hold-time constant.
- R6 : (20 to 70 k $\Omega$ )  
Determines motor speed. Select this according to the motor characteristics and the value of variable resistor VR2.

Continued on next page.



Continued from the preceding page.

- R7 : (100 to 300  $\Omega$ )  
Select this according to the motor characteristics.
- R8 : (0 to 200  $\Omega$ )  
Preamp negative feedback resistor.
- R9 : (3.9 k $\Omega$ )  
Bias set resistor for electrostatic microphones.  
The current into or out of the reference voltage pin (pin 21) should not be greater than  $\pm 1$  mA, or the bias of other circuits will be affected. In particular, the power amplifier output power will be reduced.
- R10 : (15 k $\Omega$ )  
Recording head bias set resistor. Since the bias reference voltage is the filtered DC voltage on pin 19, excessive current should not be drawn by R10, or the reference voltage on pin 21 will be affected.  
The following diagram shows the internal circuit of the reference voltage generator.

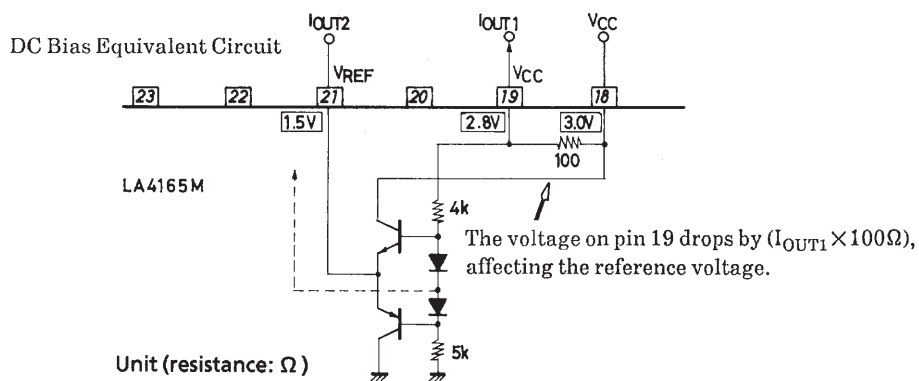

- R11 : (5 to 20 k $\Omega$ )  
Select this to match the electrostatic microphone output characteristics.
- VR1 : (10 to 30 k $\Omega$ )  
Adjusts the output level in playback mode, and the voice sensor sensitivity in record mode.
- VR2 : (5 to 30 k $\Omega$ )  
Motor speed fine adjustment.
- LED : (Red LED)  
Illuminated while recording. The LED starts to go out when  $V_{CC}$  drops to 2.2 V, and is completely extinguished when  $V_{CC}$  drops to 1.8 V.

| Pin No. | Symbol               | Pin Name             | Voltage [V] |
|---------|----------------------|----------------------|-------------|
| 1       | V <sub>EQC</sub>     | Equalizer C          | 1.5         |
| 2       | V <sub>PRE OUT</sub> | Pre out              | 1.5         |
| 3       | V <sub>PWR IN</sub>  | Power in             | 1.5         |
| 4       | V <sub>OUT</sub>     | Power out            | 1.5         |
| 5       | ALC                  | Auto Level Cont      | 0           |
| 6       | VOX CONT             | Voice Ope Cont       | 0           |
| 7       | VOX SW               | Voice Ope Switch     | 3.0         |
| 8       | VOX RECOV            | Voice Ope Recorder   | 0           |
| 9       | VOX C                | Voice Ope C          | 0           |
| 10      | V <sub>CC</sub>      | GVN V <sub>CC</sub>  | 3.0         |
| 11      | V <sub>OUT GVN</sub> | GVN out              |             |
| 12      | GND GVN              | GVN GND              | 0           |
| 13      | VS GVN               | VS GVN               |             |
| 14      | V <sub>REF GVN</sub> | GVN V <sub>REF</sub> | 1.2         |
| 15      | GVN CONT             | GVN Cont             |             |
| 16      | LED                  | LED Drive            |             |
| 17      | GND                  | Power GND            | 0           |
| 18      | V <sub>CC</sub>      | V <sub>CC</sub>      | 3.0         |
| 19      | R.F                  | Ripple Filter        | 2.8         |
| 20      | R/P CONT             | REC/PLAY Cont        | 3.0         |
| 21      | V <sub>REF</sub>     | V <sub>REF</sub>     | 1.5         |
| 22      | IN                   | Pre in               | 1.5         |
| 23      | NF                   | Pre NF               | 1.5         |
| 24      | GND                  | Pre GND              | 0           |

**Design Notes**

1. Locate the LC4165M as close as possible to the power source, to prevent voltage and power loss due to supply line resistance.

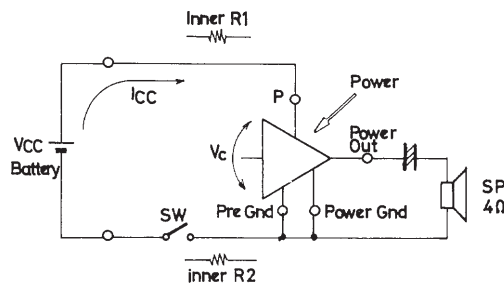

Change "Inner R<sub>1</sub>" to "Wiring resistance R<sub>1</sub>"

Change "Inner R<sub>2</sub>" to "Wiring resistance R<sub>2</sub>"

The total wiring resistance R<sub>T</sub> = R<sub>1</sub> + R<sub>2</sub> causes the voltage V<sub>C</sub> at the IC supply pins to drop from the source voltage V<sub>CC</sub> to

$$V_C = V_{CC} - I_{CC} (R_1 + R_2)$$

The power output from the amplifier is equal to

$$P_0 \propto (V_C)^2$$

## LA4165M

2. Keep the supply lines for the amplifier circuits separate from those for the motor drive circuit. This will reduce the effect of motor noise on the amplifiers and help prevent voltage drop due to motor load from affecting the amplifier supply voltage.

The recommended supply layout for the LA4165M power supply lines is shown below.

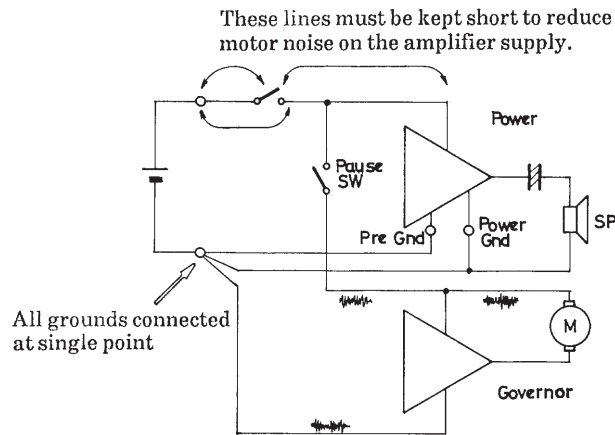

3. Do not connect a resistor to pin 6. The capacitor on this pin is being charged by a small current to determine the voice sensor attack time. Bypassing this capacitor with a resistor will increase attack time, and possibly prevent the voice sensor circuit from turning on.

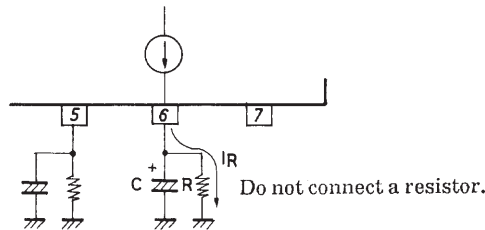

4. The voice sensor circuit has approximately 6 dB hysteresis. It turns on at a voltage on pin 6 of approximately 1.1 V and turns off at approximately 0.65 V. Biasing pin 6 higher than 0.65 V will cause it to remain on. The voice sensor equivalent circuit is shown below.

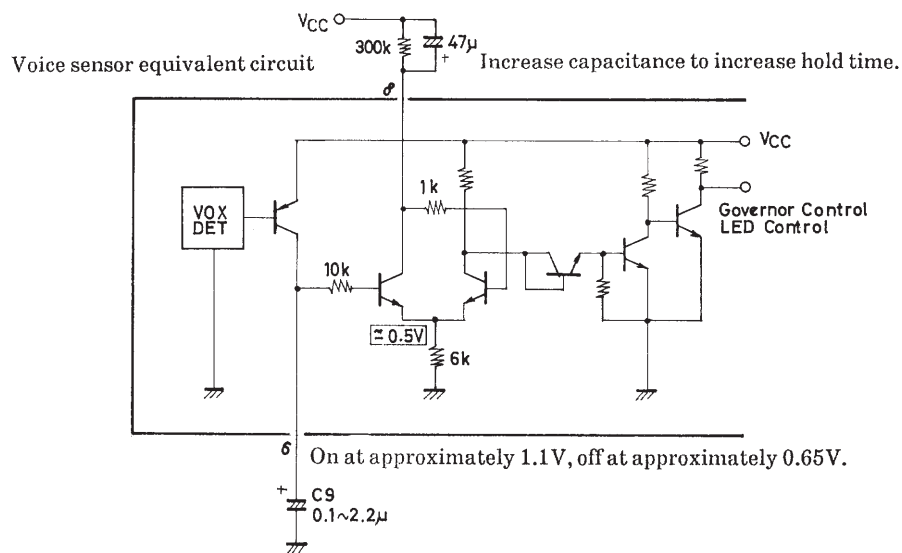

Unit (resistance: Ω, capacitance: F)

5. In record mode, grounding pin 8 will turn off the voice sensor circuit and keep the motor drive circuit operating continuously.

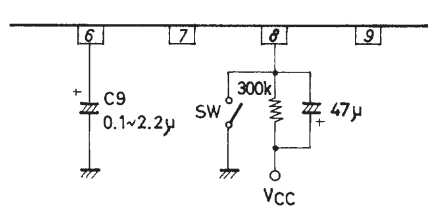

Unit (resistance:  $\Omega$ , capacitance: F)

6. Pin 7 is close to 0 V when the governor circuit is on, and close to  $V_{CC}$  when it is off. The voice sensor output stage equivalent circuit is shown below.

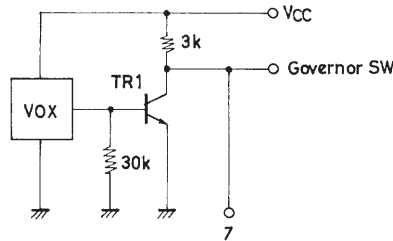

Unit (resistance:  $\Omega$ )

7. Pin 16 is used solely for driving an external LED, and should be left open when an LED is not used. It is active only during record mode while the motor drive is on. The LED drive circuit is shown below.

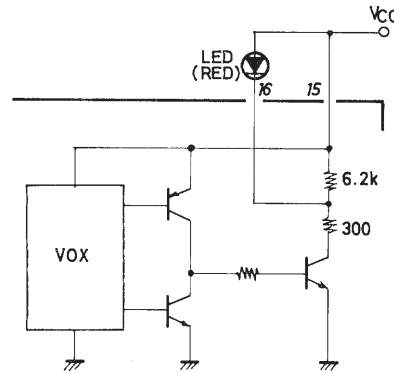

Unit (resistance:  $\Omega$ )

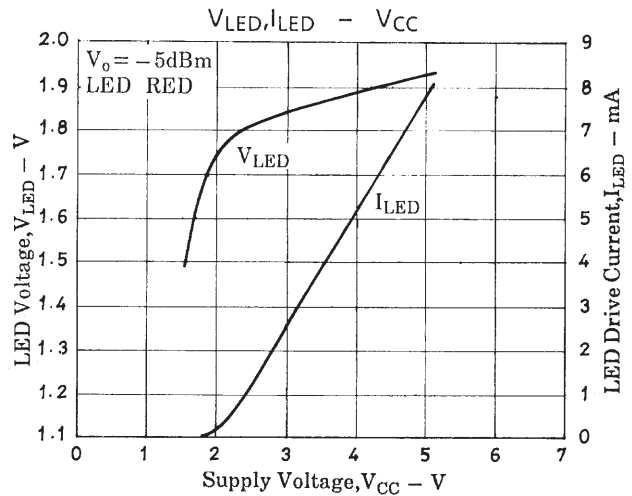
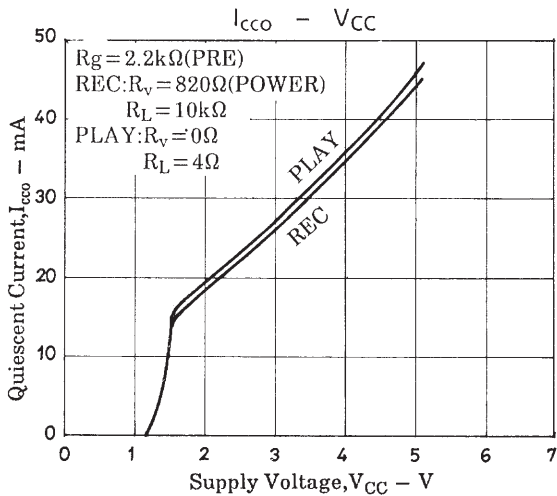

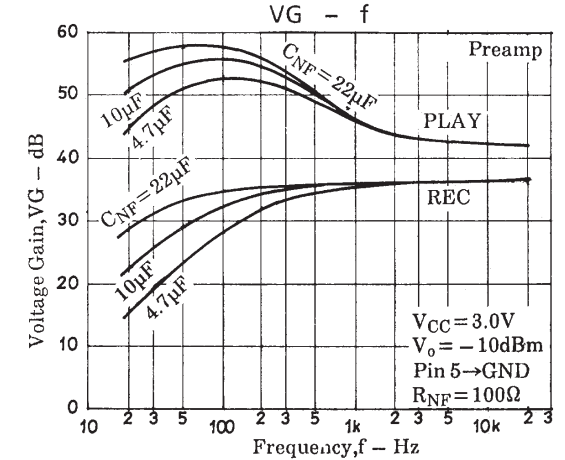
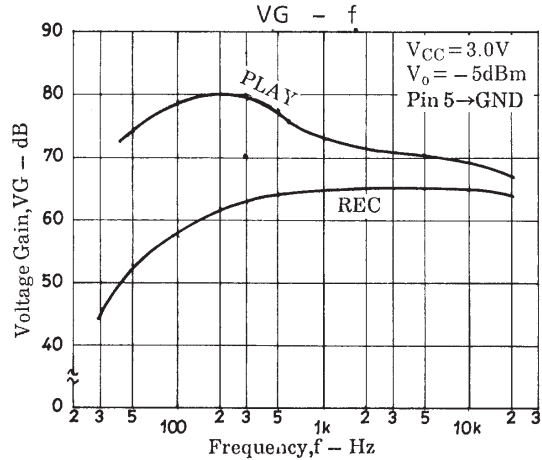
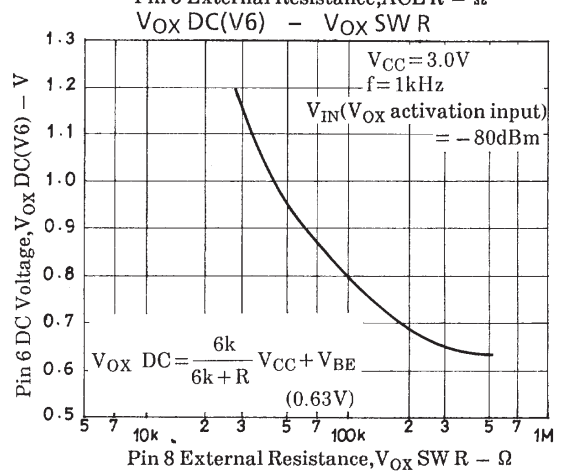
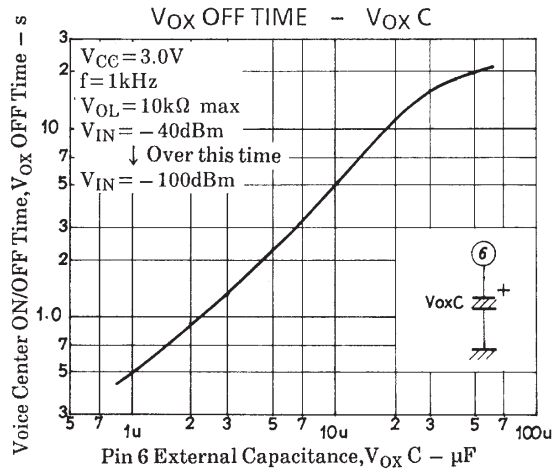
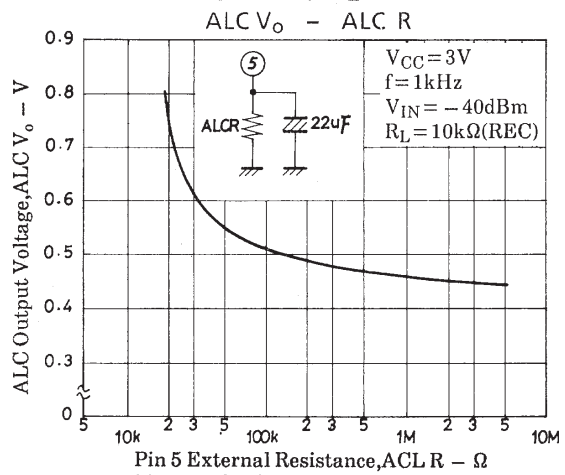
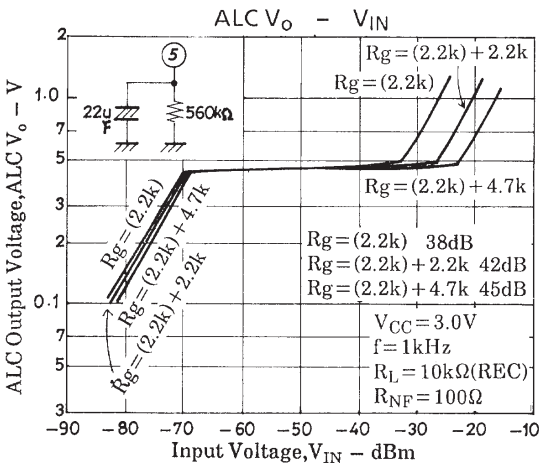
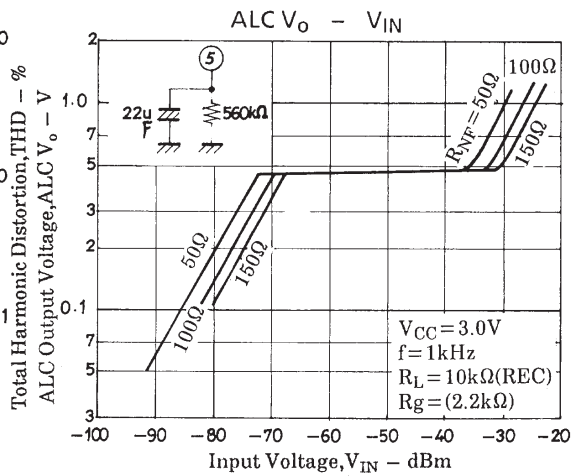
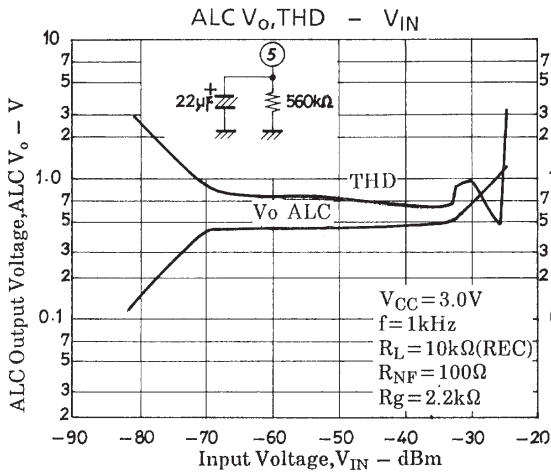

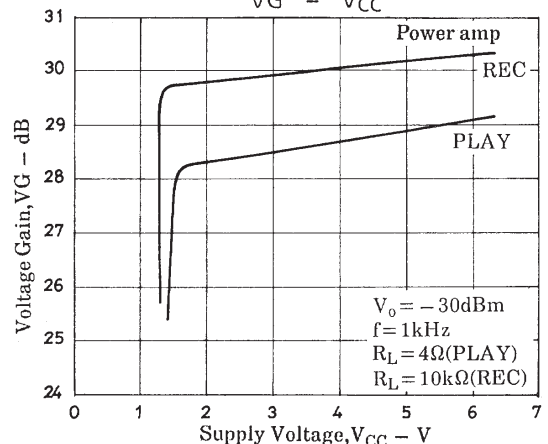
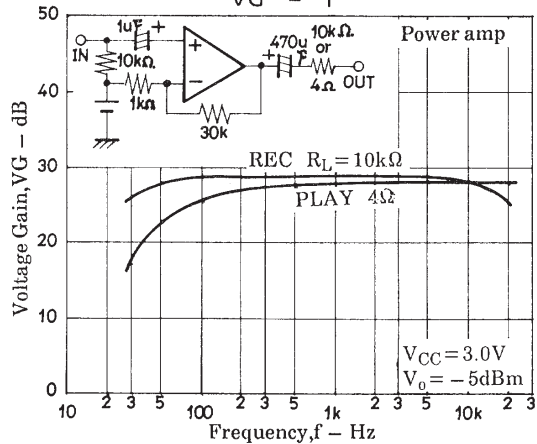
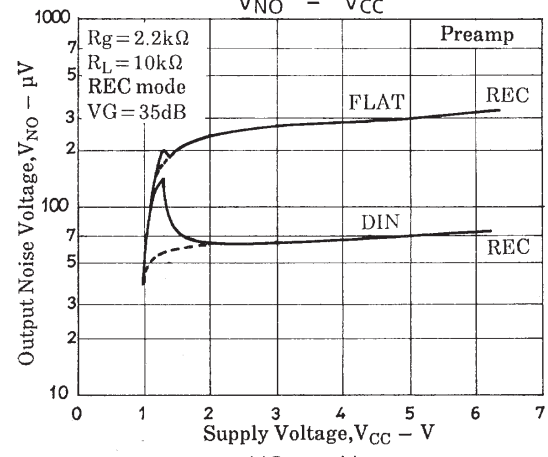
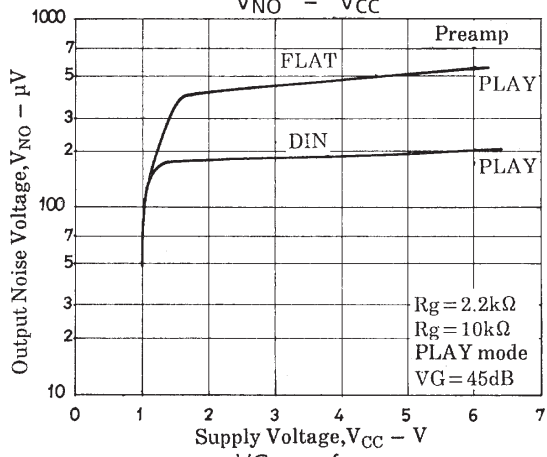
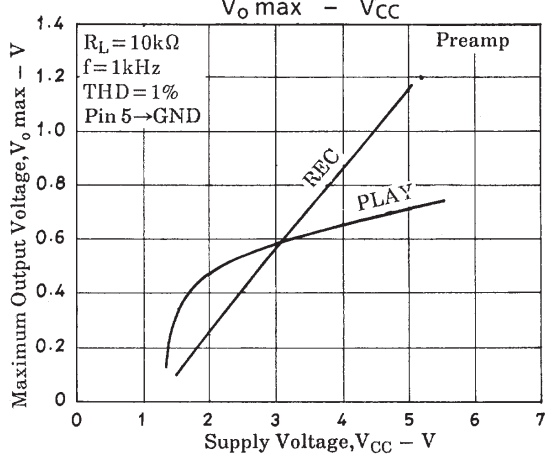
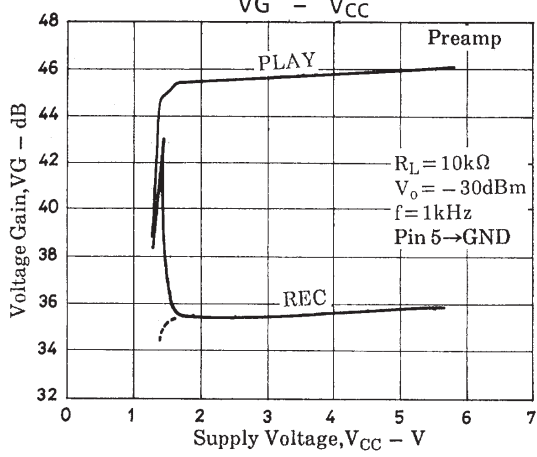
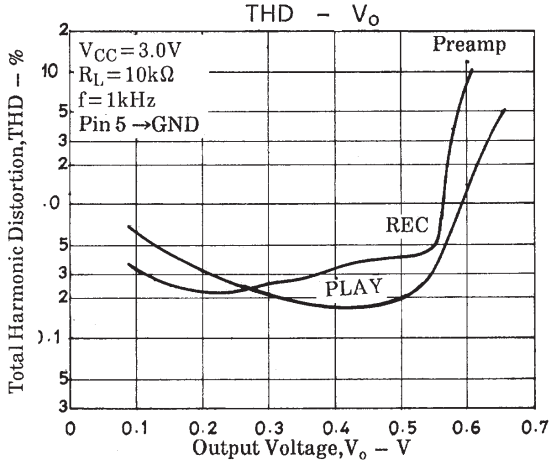
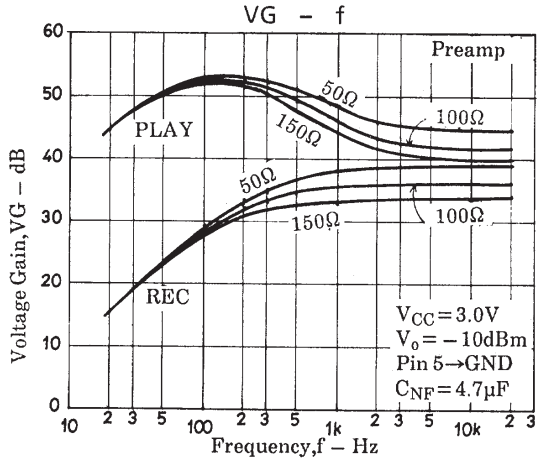

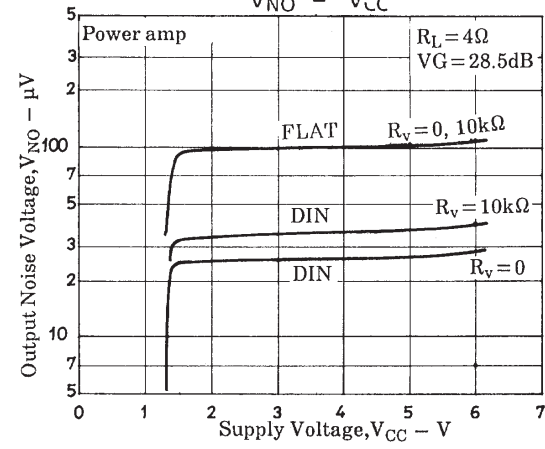
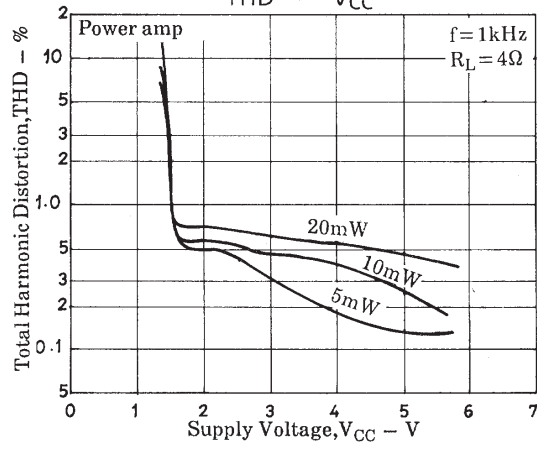
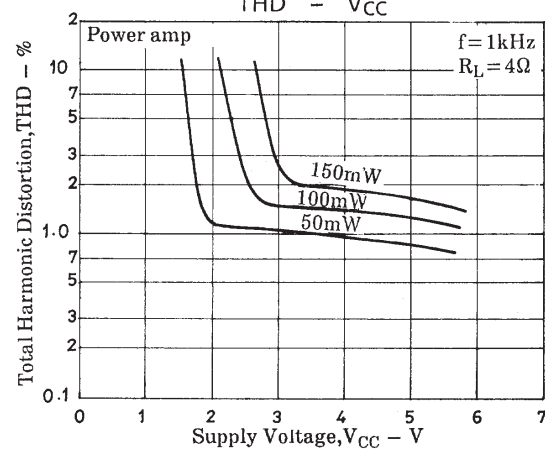
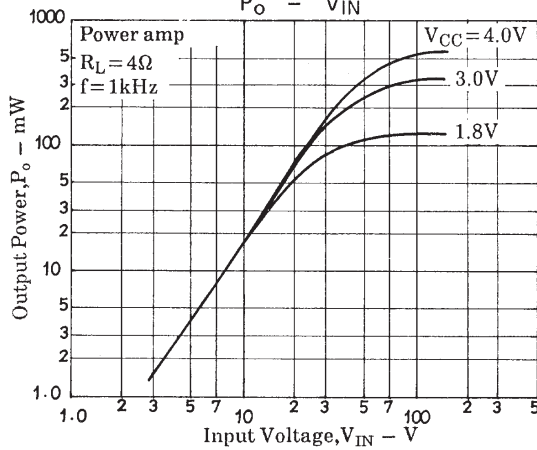
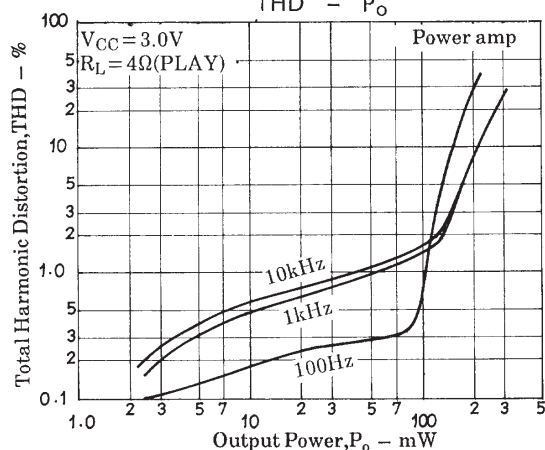
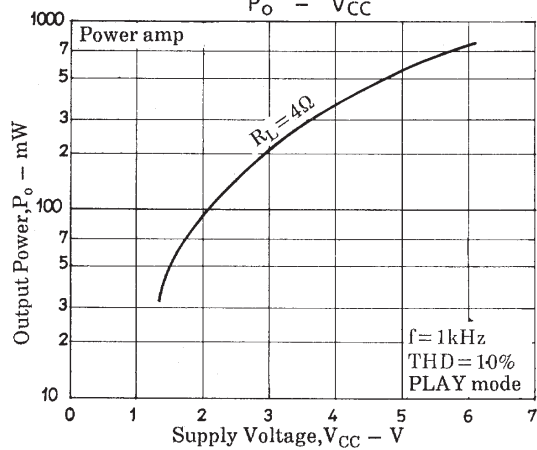
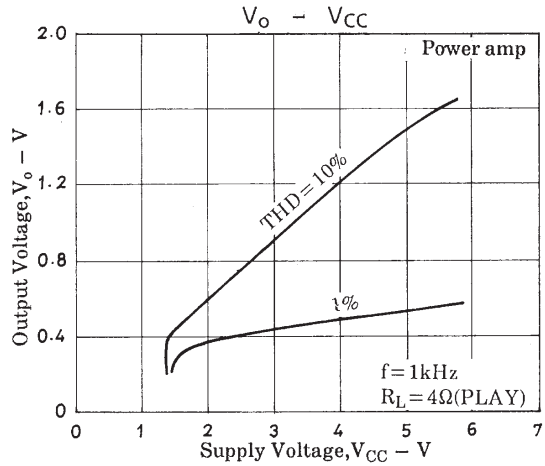
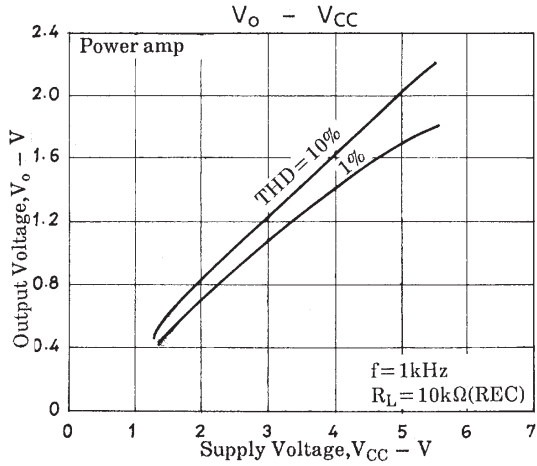

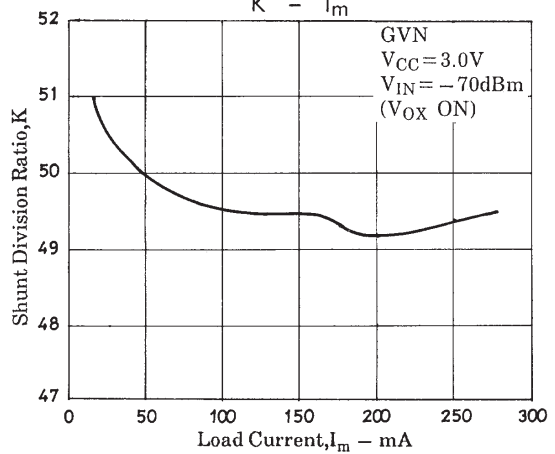
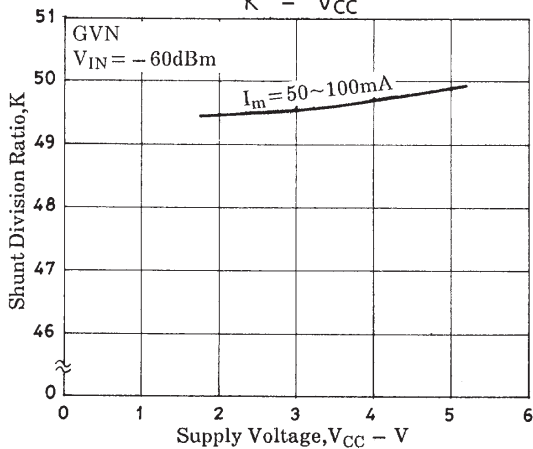
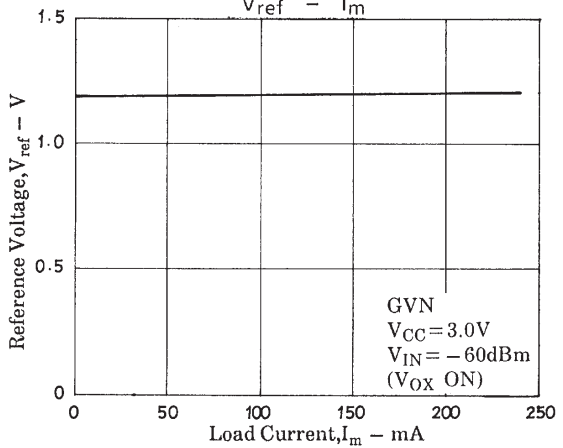
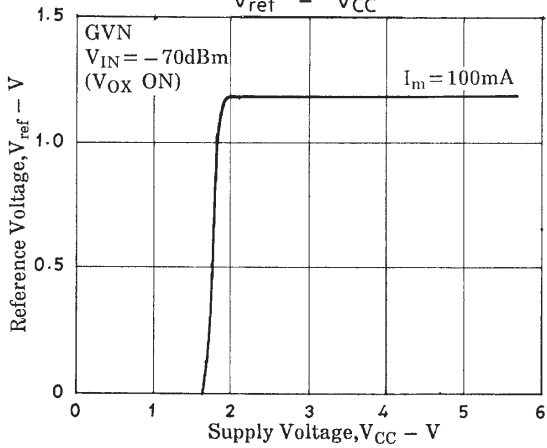
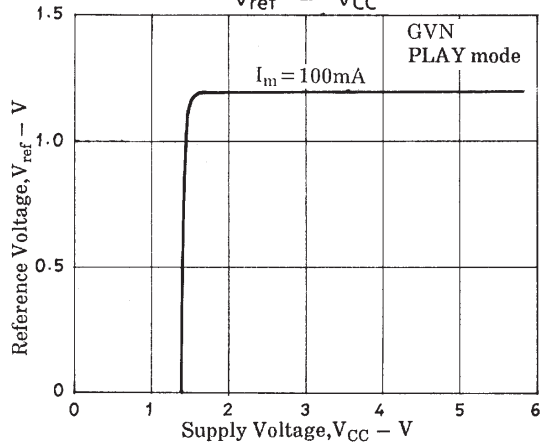
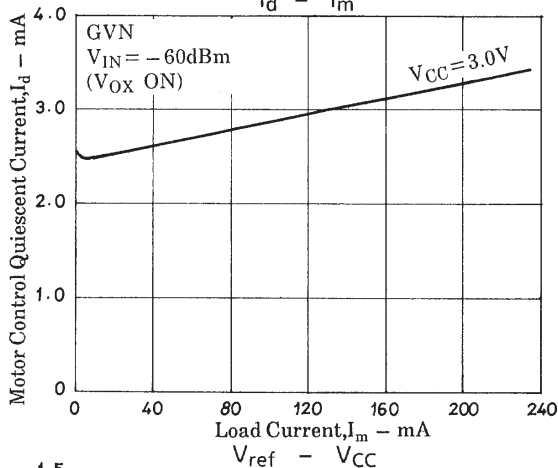
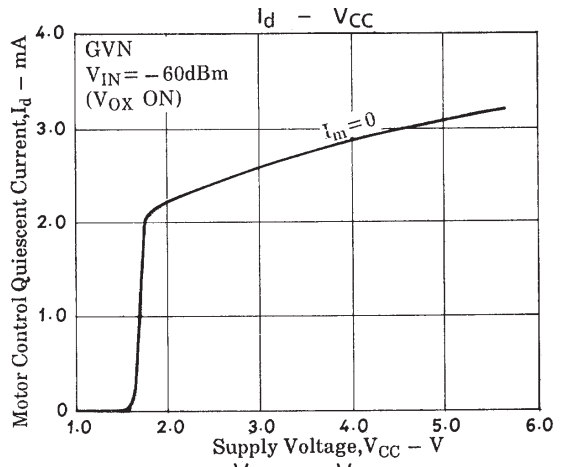
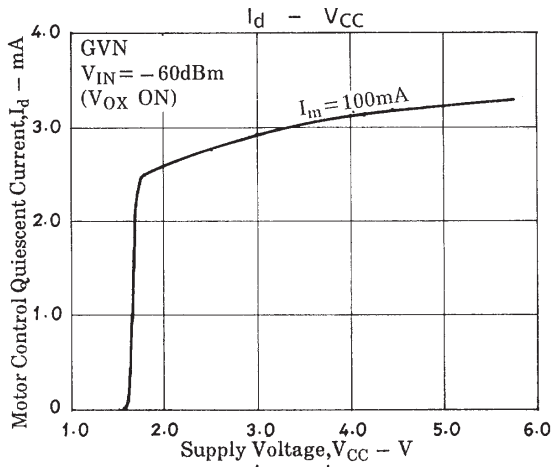



- Specifications of any and all SANYO products described or contained herein stipulate the performance, characteristics, and functions of the described products in the independent state, and are not guarantees of the performance, characteristics, and functions of the described products as mounted in the customer's products or equipment. To verify symptoms and states that cannot be evaluated in an independent device, the customer should always evaluate and test devices mounted in the customer's products or equipment.
- SANYO Electric Co., Ltd. strives to supply high-quality high-reliability products. However, any and all semiconductor products fail with some probability. It is possible that these probabilistic failures could give rise to accidents or events that could endanger human lives, that could give rise to smoke or fire, or that could cause damage to other property. When designing equipment, adopt safety measures so that these kinds of accidents or events cannot occur. Such measures include but are not limited to protective circuits and error prevention circuits for safe design, redundant design, and structural design.
- In the event that any or all SANYO products (including technical data, services) described or contained herein are controlled under any of applicable local export control laws and regulations, such products must not be exported without obtaining the export license from the authorities concerned in accordance with the above law.
- No part of this publication may be reproduced or transmitted in any form or by any means, electronic or mechanical, including photocopying and recording, or any information storage or retrieval system, or otherwise, without the prior written permission of SANYO Electric Co., Ltd.
- Any and all information described or contained herein are subject to change without notice due to product/technology improvement, etc. When designing equipment, refer to the "Delivery Specification" for the SANYO product that you intend to use.
- Information (including circuit diagrams and circuit parameters) herein is for example only; it is not guaranteed for volume production. SANYO believes information herein is accurate and reliable, but no guarantees are made or implied regarding its use or any infringements of intellectual property rights or other rights of third parties.

This catalog provides information as of December, 1999. Specifications and information herein are subject to change without notice.