



# LA1177

## Electronic Tuning-Use FM Front End for Car Radio, Home Stereos

### Overview

- The LA1177 is an FM front end IC for use in car radio, home stereo applications. It requires fewer external parts. The on-chip oscillator and oscillation buffer facilitate designing of electronic tuning sets.

### Features

- Wide-band AGC circuit (Improvement in intermodulation, cross modulation characteristics).
- On-chip local oscillation buffer (For electronic tuning).

### Functions

- Oscillator, oscillation buffer.
- Mixer.
- Wide-band AGC circuit.
- IF amplifier.

### Package Dimensions

unit: mm

#### 3017C-SIP9

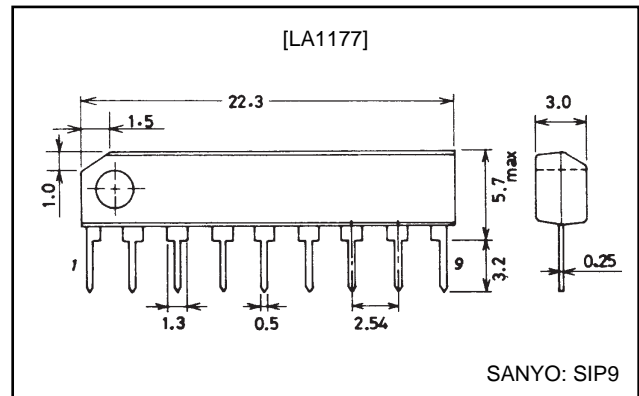

### Specifications

#### Maximum Ratings at Ta=25°C

Parameter	Symbol	Conditions	Ratings	Unit
Maximum supply voltage	V <sub>CC</sub> max	Pins 2, 9	10	V
Allowable power dissipation	P <sub>d</sub> max	T <sub>a</sub> ≤ 70°C	440	mW
Operating temperature	T <sub>opr</sub>		-20 to +70	°C
Storage temperature	T <sub>stg</sub>		-40 to +125	°C

#### Operating Conditions at Ta=25°C

Parameter	Symbol	Conditions	Ratings	Unit
Recommended supply voltage	V <sub>CC</sub>		8	V
Operating voltage range	V <sub>CC</sub> op		8 to 9	V

#### Electrical Characteristics at Ta=25°C, V<sub>CC</sub>=8V, f<sub>in</sub>=88MHz

Parameter	Symbol	Conditions	Ratings			Unit
			min	typ	max	
Quiescent current	I <sub>CCO</sub>	No input	21	26	31	mA
AGC high-level voltage	V <sub>AGC-H</sub>	V <sub>IN</sub> =0dBμ	7.7	8.0		V
AGC low-level voltage	V <sub>AGC-L</sub>	V <sub>IN</sub> =100dBμ		0.07	0.3	V
AGC mixer input voltage	V <sub>i</sub> AGC	V <sub>AGC</sub> ≤ 2V, Pin 3	73	80	87	dBμ
IF saturation output voltage	V <sub>IF-max</sub>	V <sub>IN</sub> =1.0dBμ	108	112	116	dBμ
Input limiting voltage	V <sub>i</sub> lim		76	83	90	dBμ
Voltage gain	VG	V <sub>IN</sub> =65dBμ	88	92	96	dBμ
Local OSC output voltage	V <sub>OSC</sub>	No input, 75Ω termination	80	84	88	dBμ

Evaluation Circuit and Internal Equivalent Circuit Block Diagram

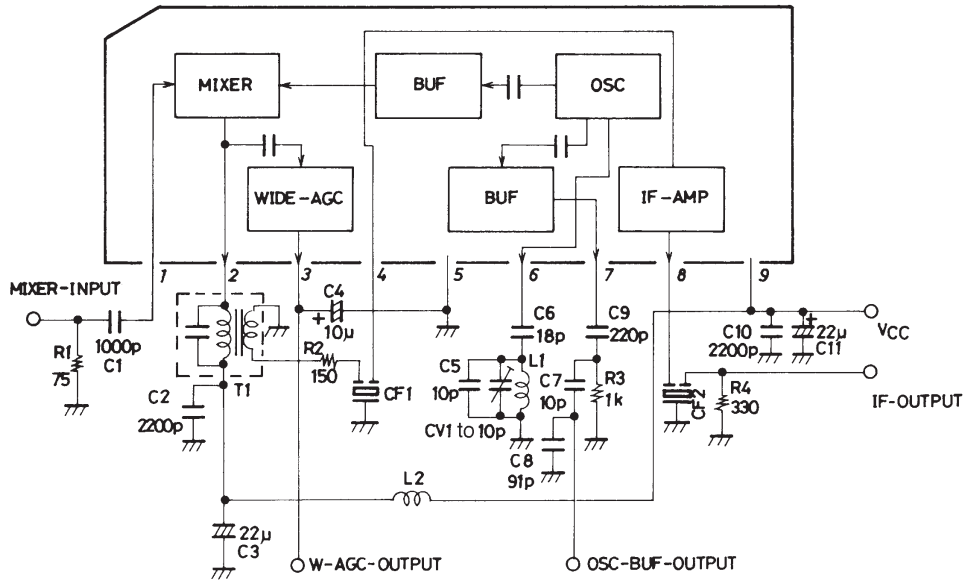

Unit (resistance : Ω, capacitance : F)

T1 : YT30224 (Mitsumi)  
 L1 : HU-50448 (Mitsumi)  
 CF1-CF2 : SFE10.7MA (Murata)

Typical Voltage on Each Pin

Pin No.	Typical voltage	Description	Remarks
1	2.7V	Mixer input	
2	8.0V	Mixer output	
3	8.0V	AGC input	No input
4	2.0V	IF input	
5	0V	GND	
6	4.9V	Oscillator base terminal	
7	1.4V	Oscillation buffer output	
8	4.4V	IF output	
9	8.0V	V <sub>CC</sub>	

Note : Extreme caution should be exercised when applying voltage across pin 9 (+) and other pins as dielectric breakdown may occur.

Sample Application Circuit

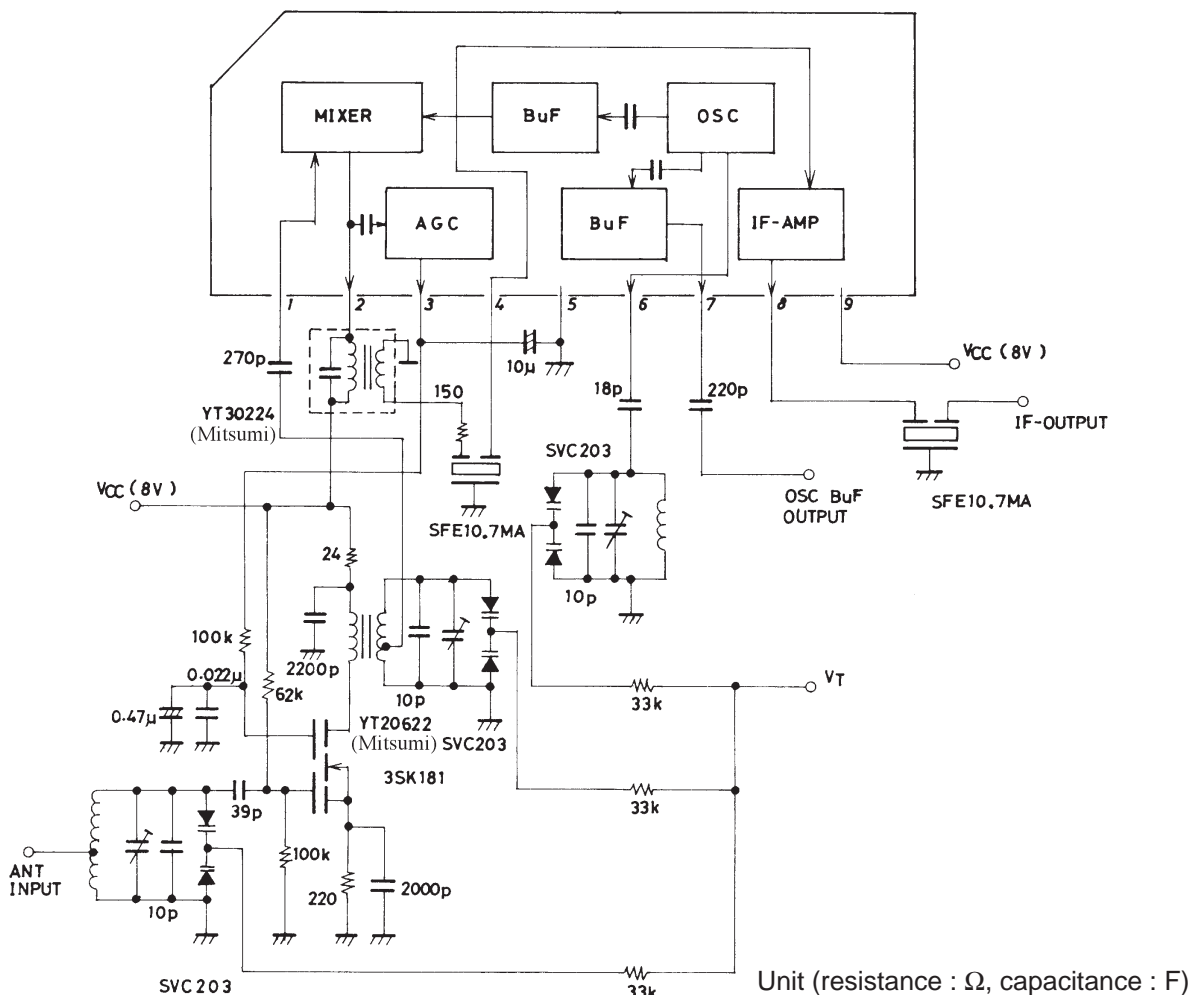

Sample Printed Circuit Pattern

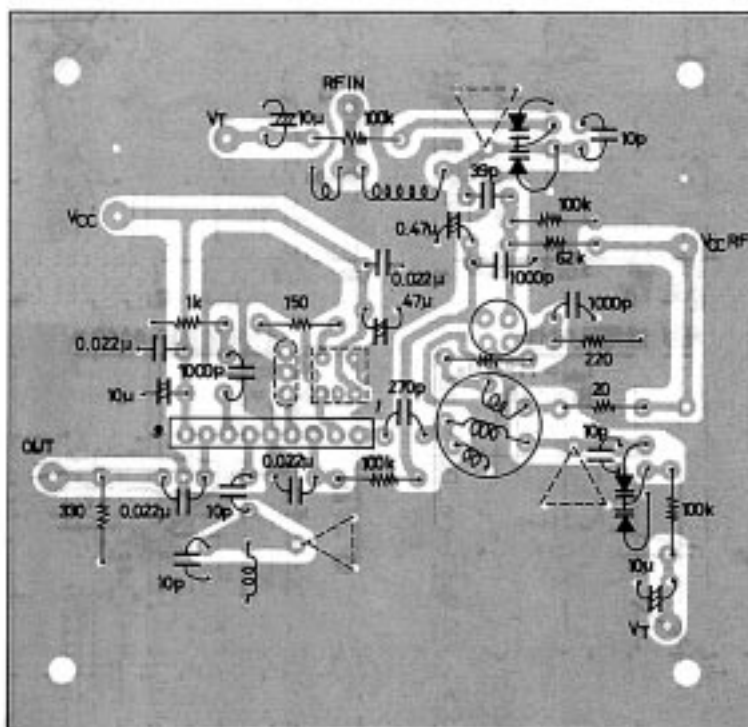

Cu-foiled area 85×82 mm<sup>2</sup>

Unit (resistance : Ω, capacitance : F)

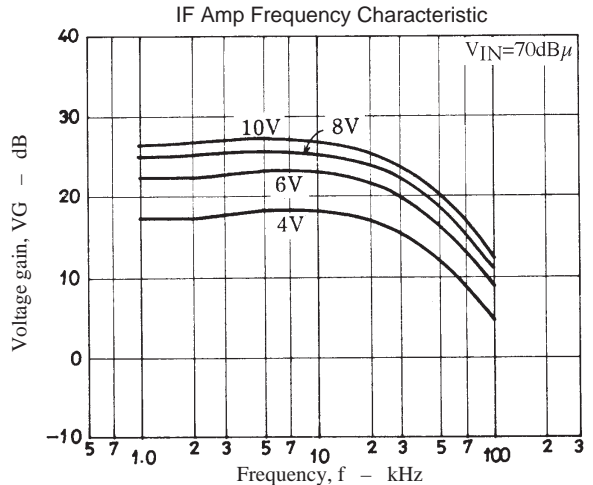
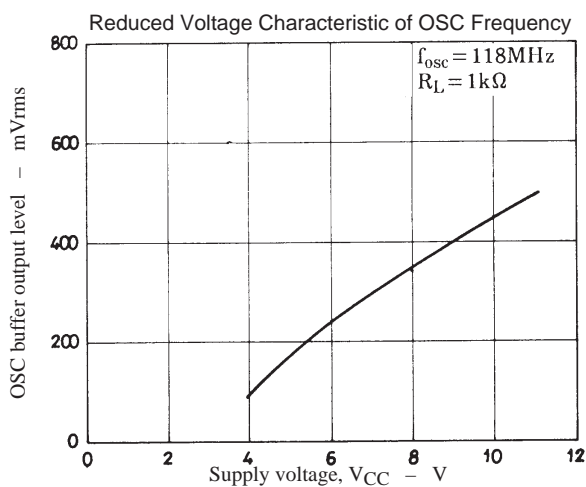
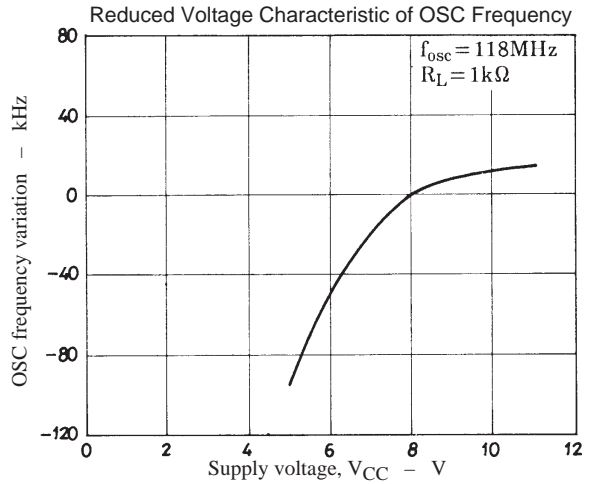
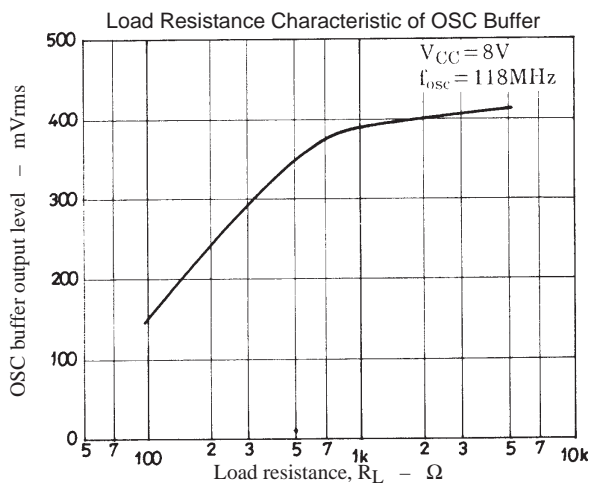
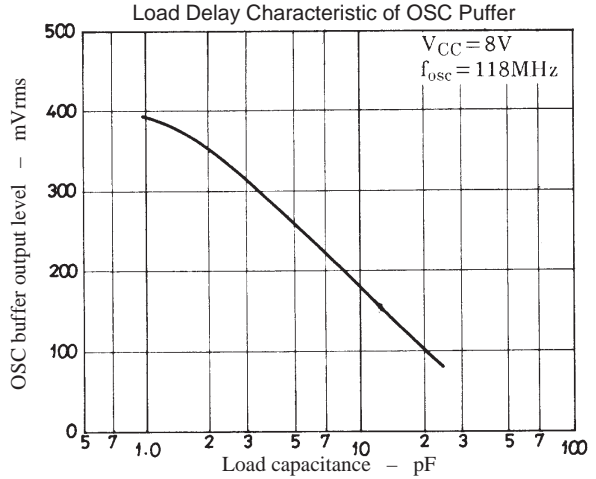
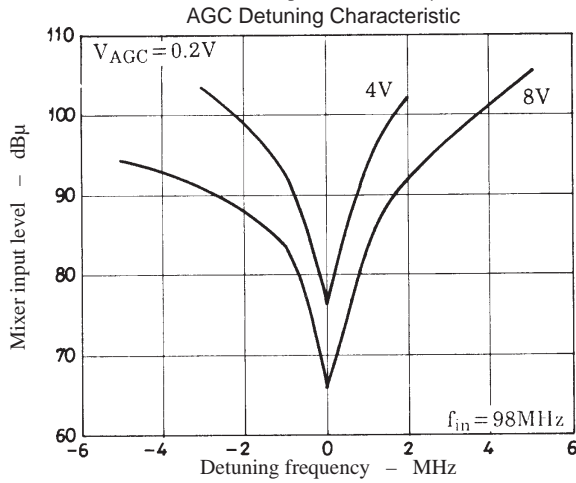
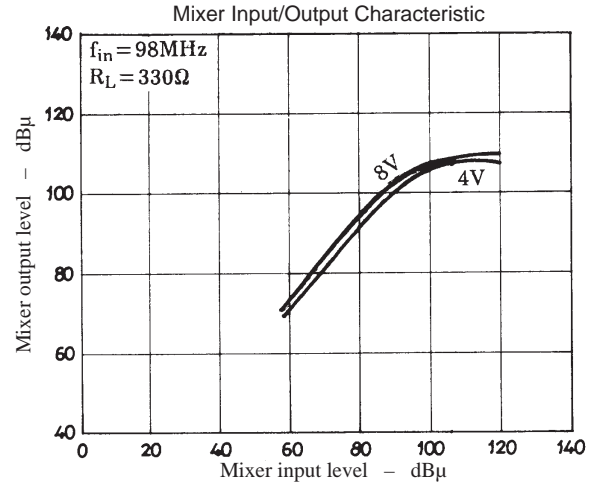
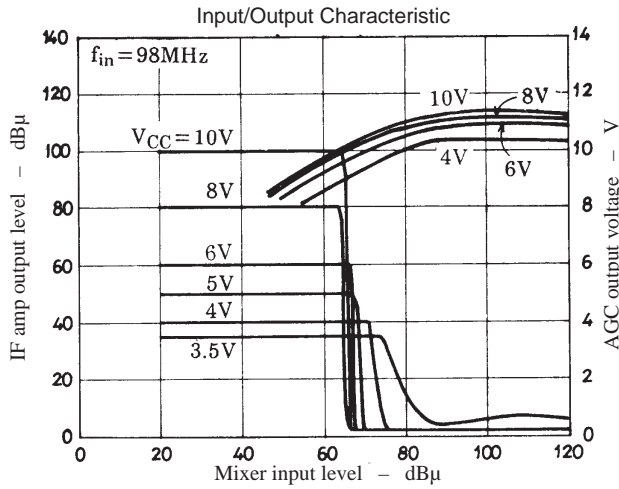

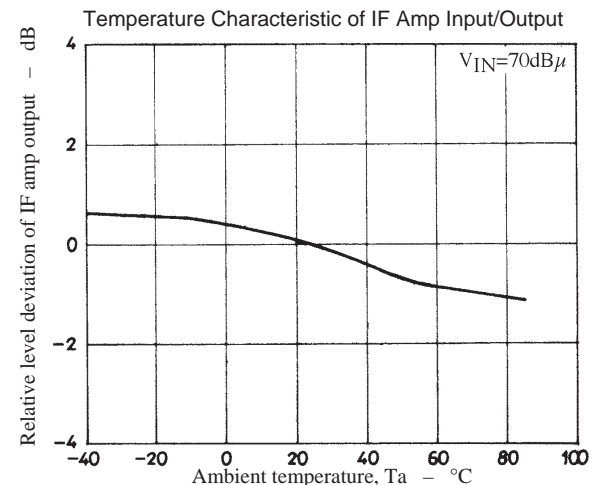
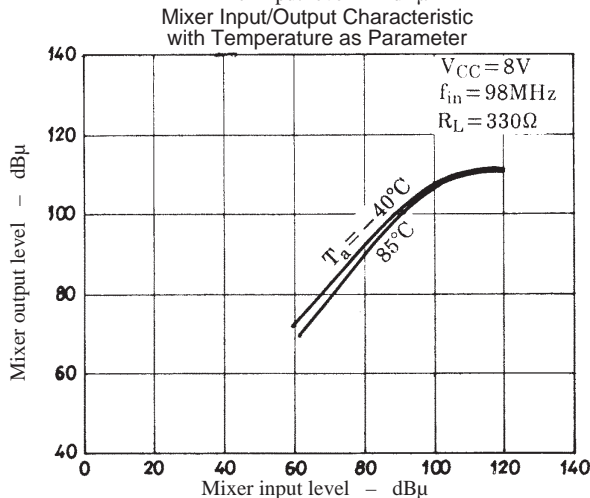
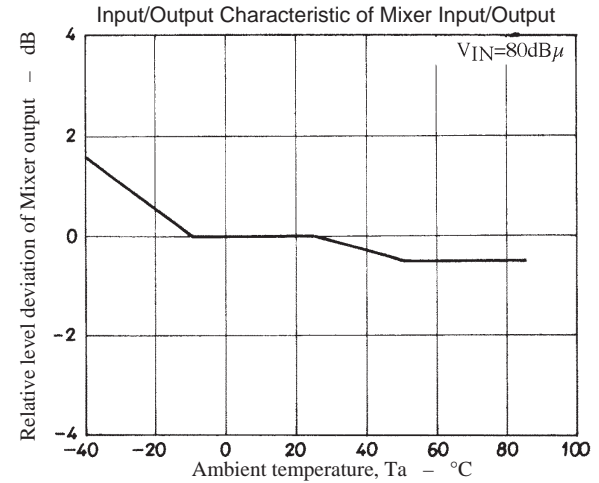
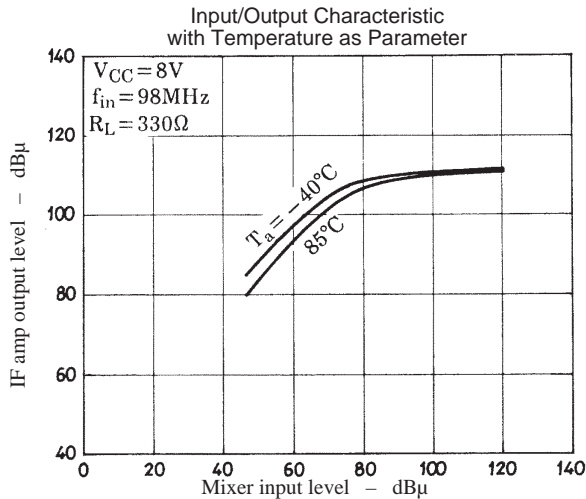
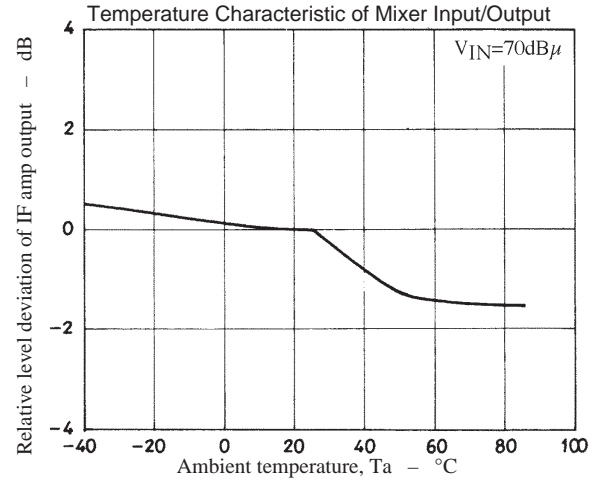
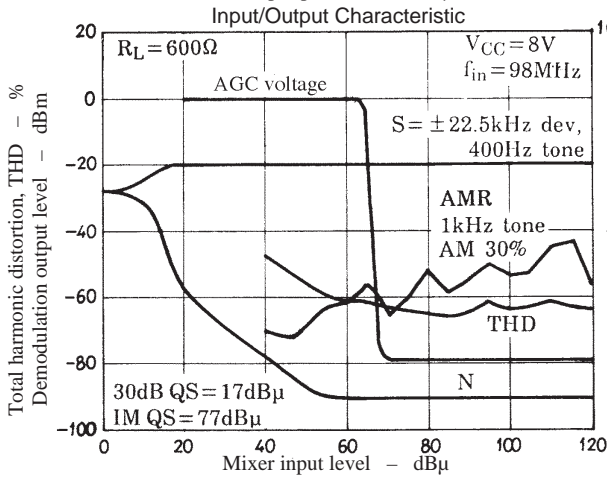
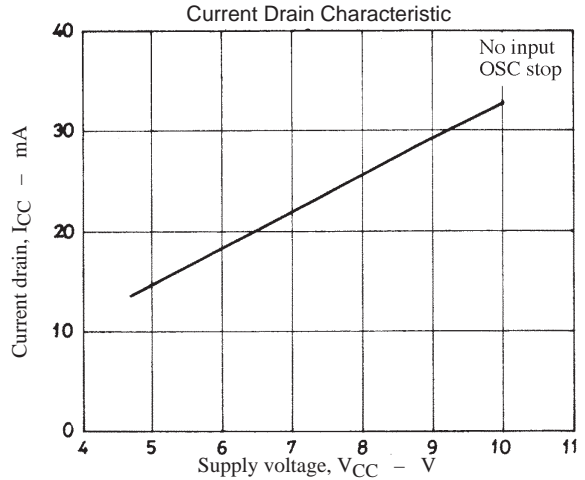
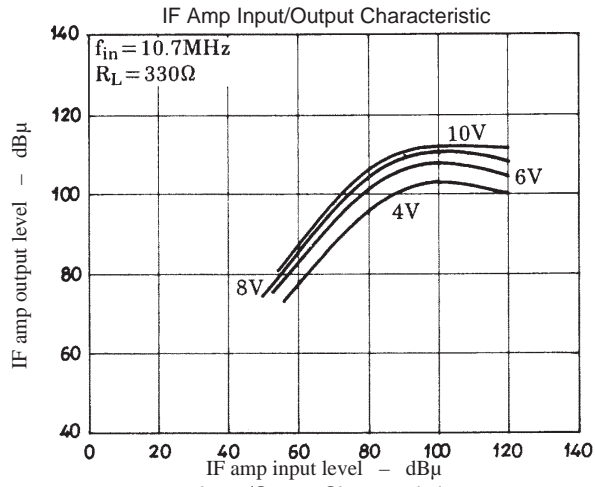

IF Amp Input/Output Characteristic with Temperature as Parameter

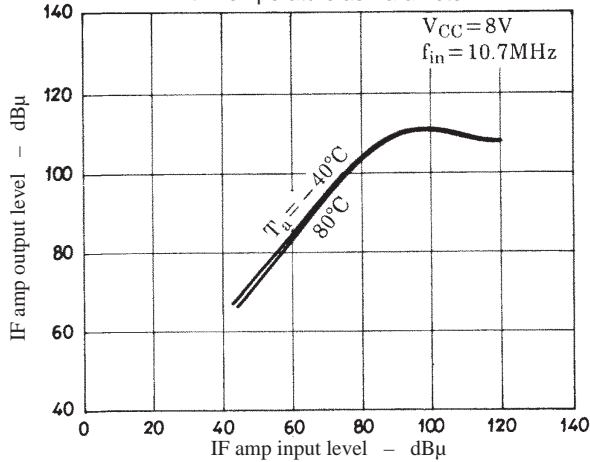

Temperature Characteristic of Mixer Input level at which AGC Voltage is Inverted

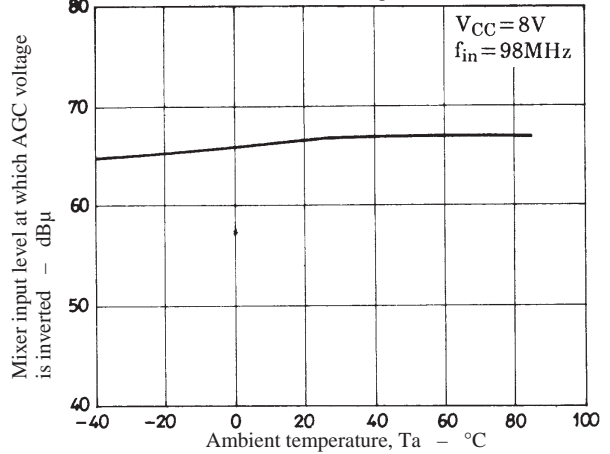

Temperature Characteristic of VAGC-L Voltage

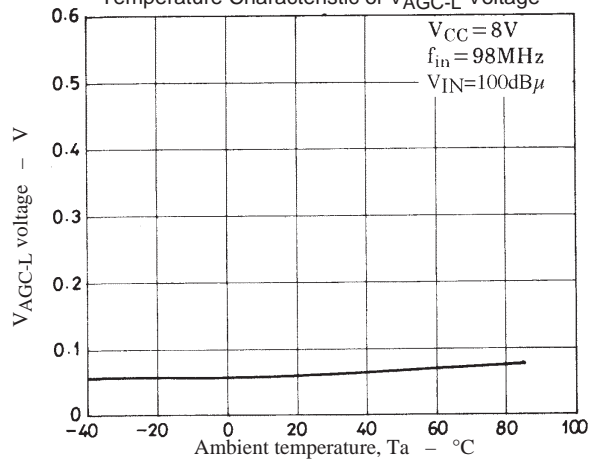

Temperature Characteristic of VAGC-H Voltage

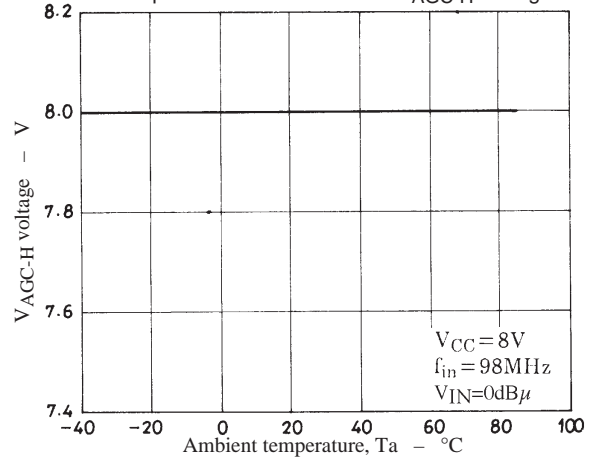

Temperature Characteristic of OSC Frequency

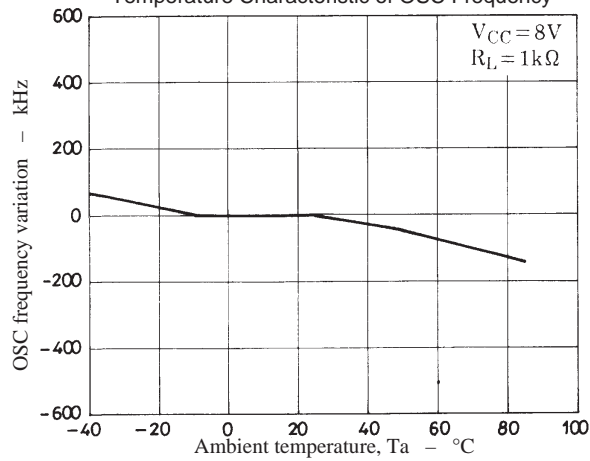

Temperature Characteristic of OSC Buffer Output

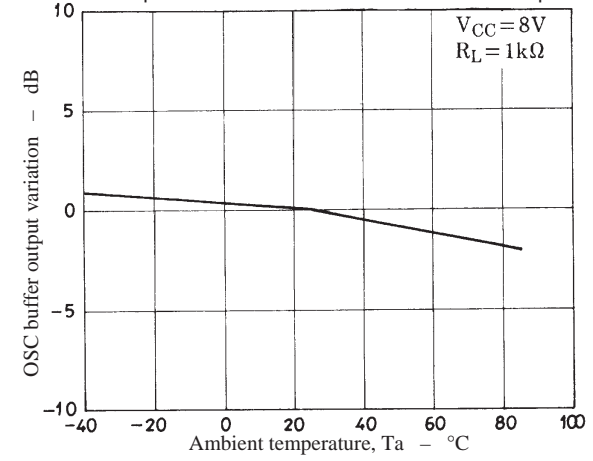

OSC Frequency Characteristic

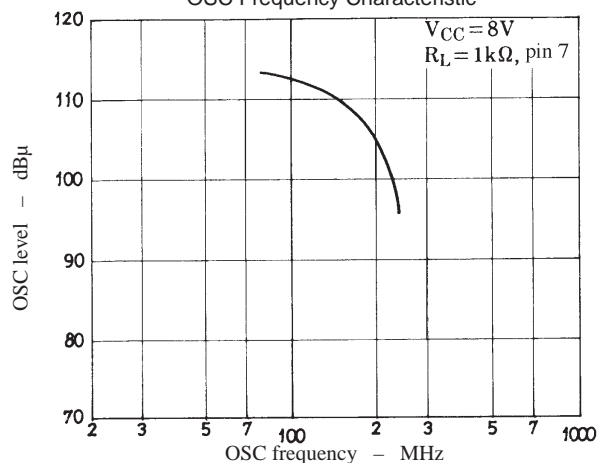

Reception Sensitivity Characteristic

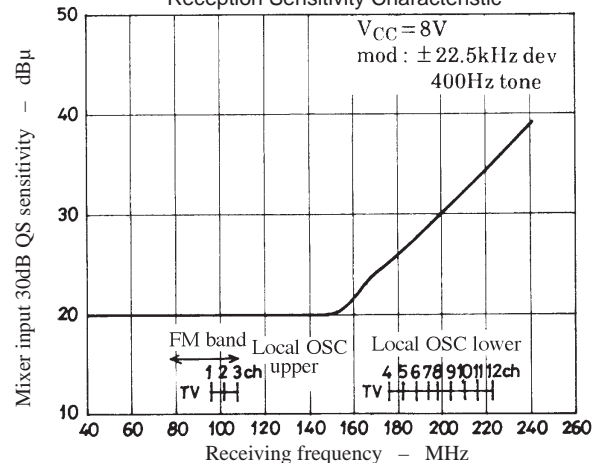

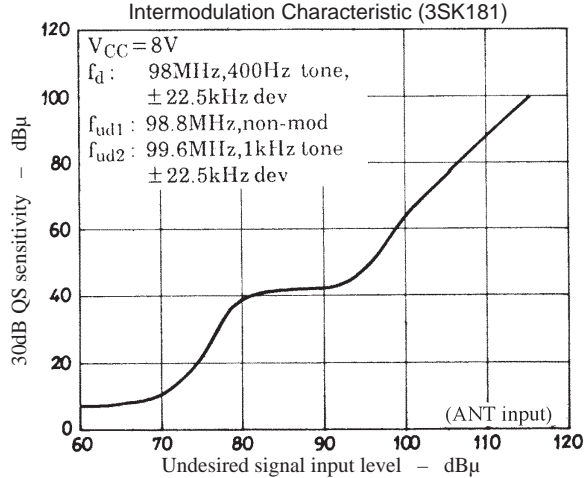
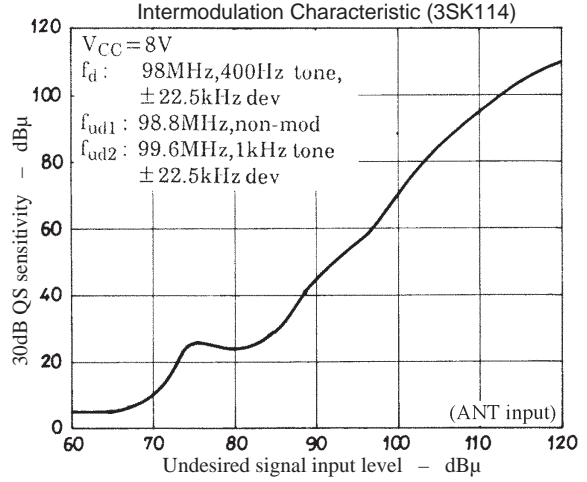
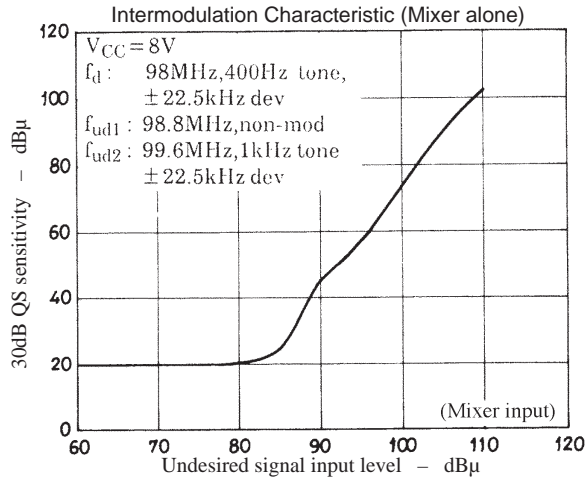
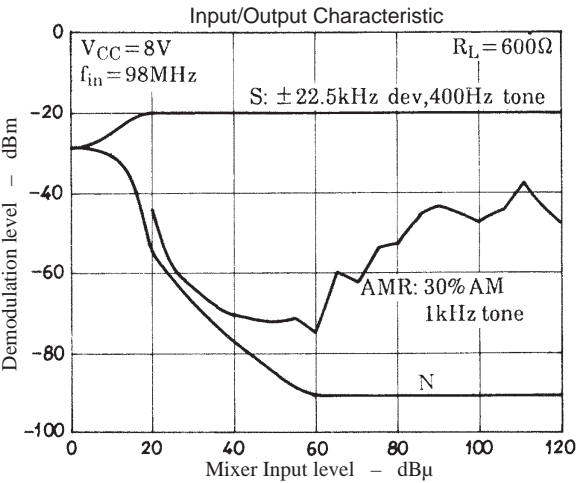
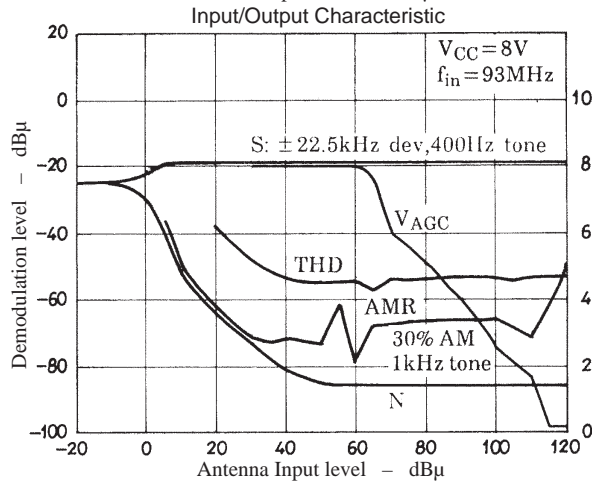
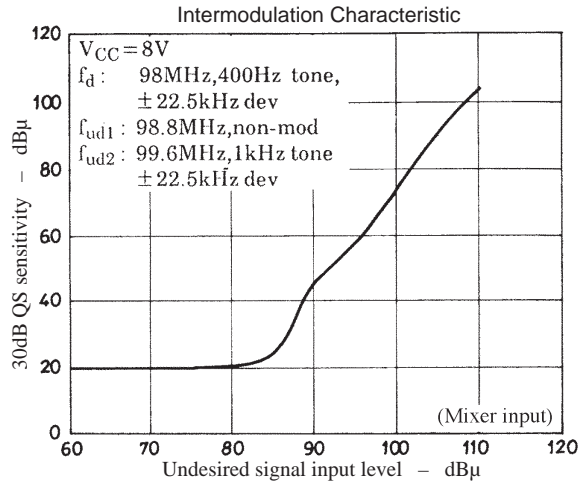
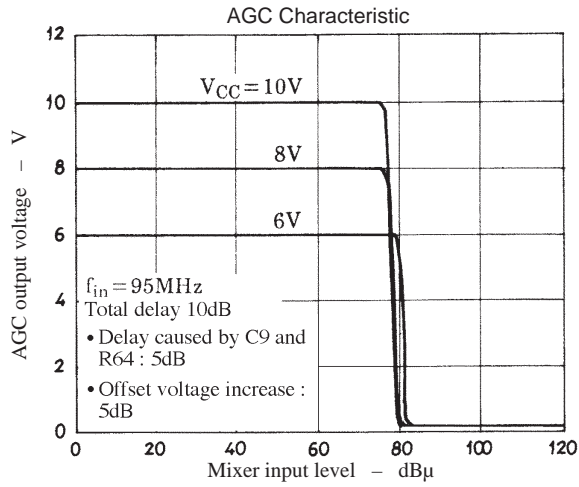

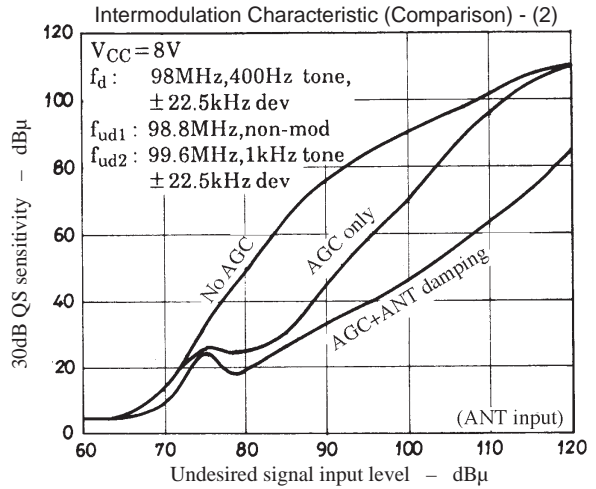
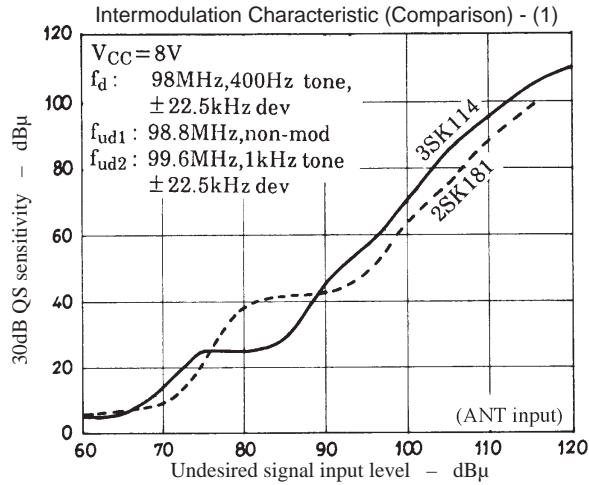

■ No products described or contained herein are intended for use in surgical implants, life-support systems, aerospace equipment, nuclear power control systems, vehicles, disaster/crime-prevention equipment and the like, the failure of which may directly or indirectly cause injury, death or property loss.

■ Anyone purchasing any products described or contained herein for an above-mentioned use shall:

- ① Accept full responsibility and indemnify and defend SANYO ELECTRIC CO., LTD., its affiliates, subsidiaries and distributors and all their officers and employees, jointly and severally, against any and all claims and litigation and all damages, cost and expenses associated with such use:
- ② Not impose any responsibility for any fault or negligence which may be cited in any such claim or litigation on SANYO ELECTRIC CO., LTD., its affiliates, subsidiaries and distributors or any of their officers and employees jointly or severally.

■ Information (including circuit diagrams and circuit parameters) herein is for example only; it is not guaranteed for volume production. SANYO believes information herein is accurate and reliable, but no guarantees are made or implied regarding its use or any infringements of intellectual property rights or other rights of third parties.

This catalog provides information as of September, 1997. Specifications and information herein are subject to change without notice.