

INTRODUCTION

The S1A0427B01 is a monolithic integrated circuit designed for portable AM/FM radios or AM/FM clock radios.

FUNCTIONS

- AM RF & MIX
- AM AGC
- AM/FM DET
- Regulator
- AM Local OSC
- AM/FM IF AMP
- Audio Power AMP
- FM AFC Control

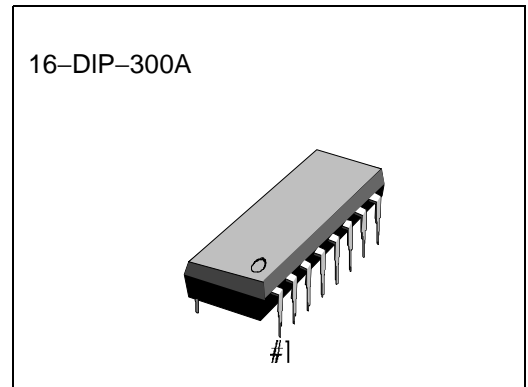

FEATURE

- Portable AM/FM 1-chip radio
- Wide operating supply voltage range: $V_{CC} = 3V - 12V$ (Approximately) (Depending on the internal regulator tolerance)
- Recommended operating supply voltage: $V_{CC} = 4.5V - 9V$

$R_L \backslash V_{CC}$	4.5V	6.0V	7.5V	9.0V	Line Operated
8Ω	O	O	O	X	X
16Ω	O	O	O	O	X
45Ω	O	O	O	O	O

- When using the AC line as an internal shunt regulator mode, it is possible to use a low cost application without a transformer (approximately 42mA)
- IF AMP gain is determined by the DC voltage appearing at IC Pin 16.
- Power output: $P_C = 0.28W$ (Min.) at THD = 10% ($V_{CC} = 5.5V/8Ω$).

ORDERING INFORMATION

Device	Package	Operating Temperature
S1A0427B01-D0B0	16-DIP-300A	20°C – +70°C

BLOCK DIAGRAM

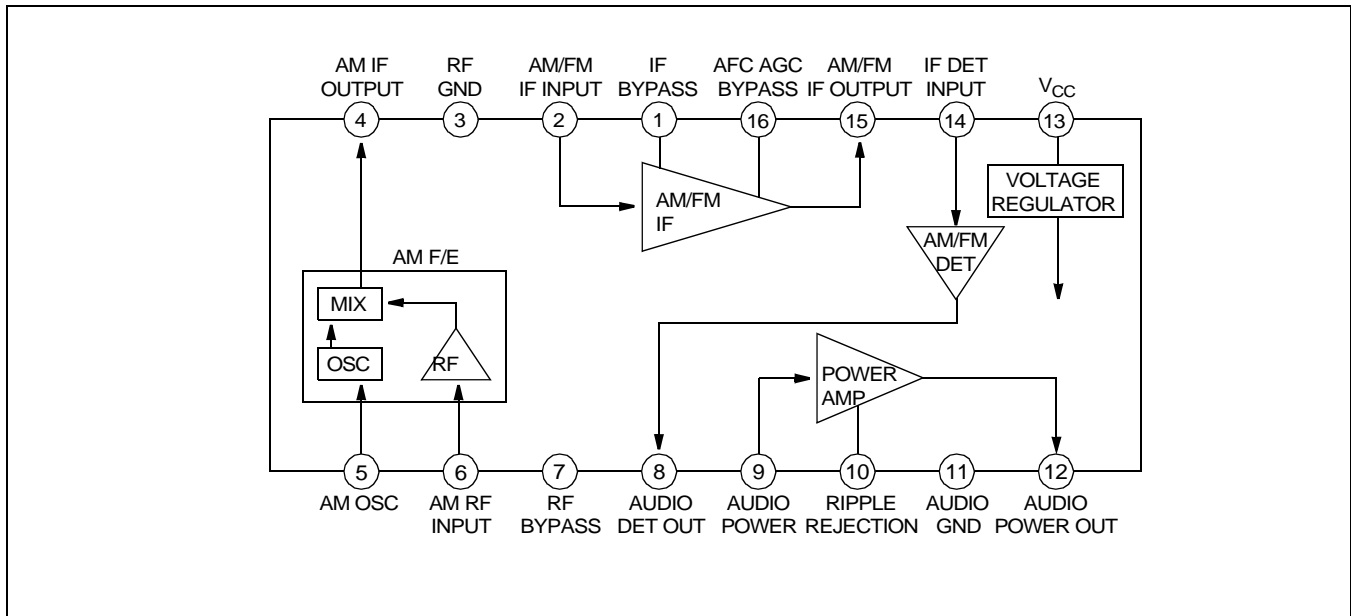
ABSOLUTE MAXIMUM RATINGS ($T_a = 25^\circ\text{C}$)

Character istic	Symbol	Value	Unit
Supply Voltage	V_{CC}	13	V
Power Dissipation	P_D	600	mW
Supply Current	I_{CC}	44	mA
Thermal Resistance Junction to Ambient	R_{EJA}	100	$^\circ\text{C}/\text{W}$
Operating Temperature	T_{OPR}	-20 – +70	$^\circ\text{C}$
Storage Temperature	T_{STG}	-55 – +150	$^\circ\text{C}$

ELECTRICAL CHARACTERISTICS

($T_a = 25^\circ\text{C}$, $V_{CC} = 5.5\text{V}$, $f_m = 1\text{kHz}$, AM: $f = 1\text{MHz}$, 30% Mod, FM: $f = 10.7\text{MHz}$
 $\Delta f = 22.5\text{kHz}$, unless otherwise specified)

Characteristic		Symbol	Test Conditions	Min.	Typ.	Max.	Unit
FM	Quiescent Circuit Current	I_{CCQ}	SW: FM, $V_{CC} = 3\text{V}$	7	12	17	mA
			SW: FM, $V_{CC} = 9\text{V}$	10	17	23	
	Pin 16 Terminal Voltage	$V_{16(\text{FM})}$	SW: FM, $V_{CC} = 9\text{V}$, $V_I = 0$	2.0	2.4	3.1	V
	-3 dB Limiting Sensitivity	$V_{I(\text{LIM})}$	SW: FM, -3dB $V_{16} = 2.4\text{V}$, V_R Min	-	57	-	dB
AM	Internal Regulated Vtg.	V_{CC}	SW: AM, $I_{CC} = 42\text{mA}$	12	13.2	14.0	V
	Pin 16 Voltage	$V_{16(\text{AM})}$	SW: AM, $V_{CC} = 9\text{V}$, $V_I = 0$	1.4	-	1.9	V
	Maximum Sensitivity	S_{MAX}	SW: AM, $V_{CC} = 12\text{V}$ $V_I = 37\text{dB}\mu$, $R_L = 8\Omega$	1.5	3.0	-	V
	Signal to Noise Ratio	S/N	$V_I = 37.5\text{dB}\mu$, $R_L = 8\Omega$ $P_O = 50\text{mW}$	15	20	-	dB
PWR AMP	Output Power	P_O	$f = 1\text{kHz}$, THD = 10% V_R Min, $R_L = 8\Omega$	0.28	-	-	W
	Total Harmonic Distortion	THD	$I_{CC} = 42\text{mA}$, $R_L = 45\Omega$ $f = 1\text{kHz}$, $V_O = 2\text{V}$ V_R Min	-	0.5	4.0	%
	Voltage gain	G_V	$f = 1\text{kHz}$, $R_L = 8\Omega$, $P_O = 50\text{mW}$	-	41	-	dB

TEST CIRCUIT

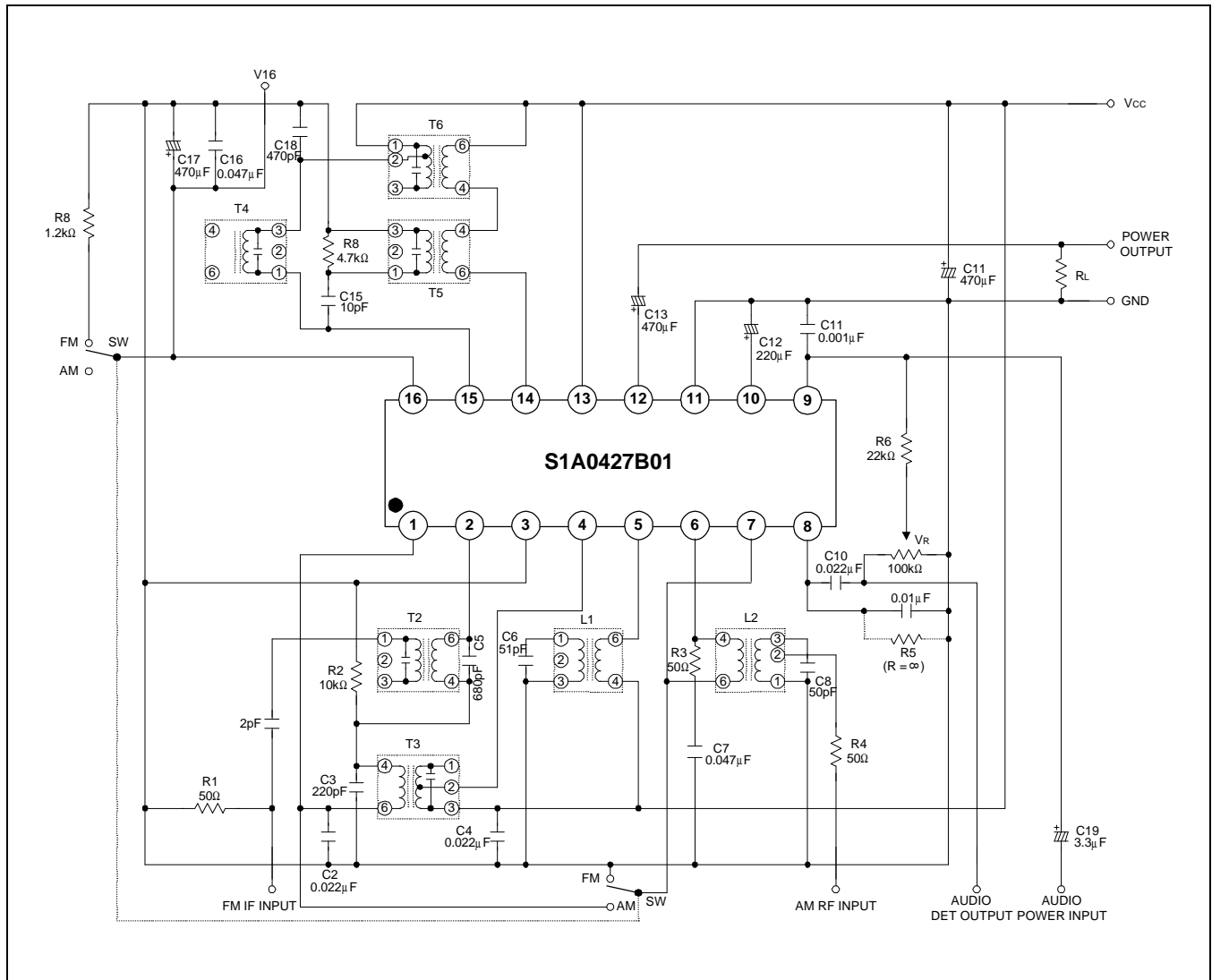

APPLICATION INFORMATION

— EXTERNAL COMPONENTS

Part Number	Purpose	Typical	Influence	
			Smaller Than Typ	Greater Than Typ
R5	Am gain Control	47kΩ (33K – ∞)	Low AM gain	AGC Distortion increase, High gain
R7	FM detector damper	4.7kΩ	Low detector output, stable IF gain, low FM gain	Sharp IF AMP curve
R8	FM gain adjust	470Ω	Low FM gain	High gain, but noise increase
C2	IF bypass	0.022μF	Should not be less than 0.005μF	High IF Gain, S/N ratio degrade
C4	IF filter	0.022μF	Removal may cause IF oscillation	No influence
C7	AM bypass	0.047μF	Low gain	Using over 1 will cause FM distortion at small signal
C9	Detector filter	0.01μF	Unstable IF AMP oscillation	Poor FM frequency response
C10	Audio coupling	0.022μF	Lower sensitivity, poor low frequency response	Bass boost affects de-emphasis curve
C11	Audio Input High-cut	0.001μF	Audio oscillation	Poor response
C12	Ripple filter	220μF	Poor frequency response & Low gain	Improve AC Hum
C13	Audio output coupling	470μF	Poor low frequency response	Can achieve optimum output power
C14	Power line filter	470μF	Poor AC Hum	Improve AC Hum
C15	FM detector phase-shift	10pF	Narrow IF bandwidth	Wide IF bandwidth
C16	High freq. (IF) bypass	0.047μF	Removal will cause fm oscillation	No influence
C17	AN AGC time constant and high frequency (IF) bypass	0.047μF	Charging not recommended	—

FUNCTION DESCRIPTION (PIN 16 DC VOLTAGE)

1. IF Gain Grouping Table

(1) Test Condition: $V_{CC} = 9V$ (Pin 13).

Pin 8 resistance (AM) = $47k\Omega$

Pin 16 resistance (FM) = $1.2k\Omega$

(2) Grouping Table

V16(FM)	V16(AM)	1.4 - 1.7 V
2.4 – 2.85V		2B

2. IF gain is determined by DC voltage appeared at IC Pin 16.

The DC voltage at Pin 16 to the following values:

AM = 1.4 – 1.65V (DC)

FM = 1.9 – 2.10V (DC)

AM gain can be adjusted by the loading resistor value of Pin 8 (AM) from $33k\Omega$ to infinity.

FM gain can be adjusted by the loading resistor value of Pin 16 (FM) from $3k\Omega$ to 680Ω .

Recommended resistance (Pin 8, Pin 16).

Pin 8 (AM) = $47k\Omega$

Pin 16 (FM) = $470k\Omega$

COIL SPECIFICATION 1

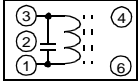
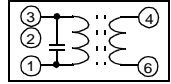
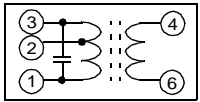
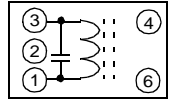
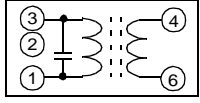
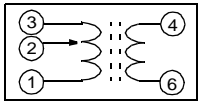
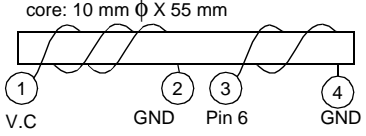
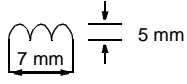
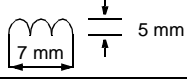
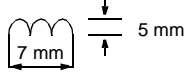
Coil No.	f	Q _O	Turns		C _O	Connections (KOREA TOKO)
T1	10.7MHz	120	1-3	8T	150 pF	
T2	10.7MHz	70 min	1-3	11T	75 ± 5 pF	
			4-6	2T		
T3 (T6)	455kHz	80 min	1-2	91T	180 ± 5 pF	
			2-3	55T		
			4-6	6T		
T4	10.7MHz	45 min	1-3	11T	82 ± 3 pF	
T5	10.7MHz	25 min	1-3	7T	180 pF	
			4-6	7T		
L1	AM Local Oscillator	90 min	1-3	86T		
			4-6	7T		
L2	AM ANT	200	1-2 (L = 560μH)	138T		
			3-4	9T		
L3	FM ANT		0.8mmφ UEW TAP	5T		
				0.5T		
L4	Trap		0.32mmφ UEW	10T		
L5	FM Oscillator		0.8mmφ UEW	4T	-	

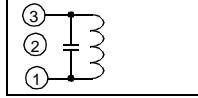
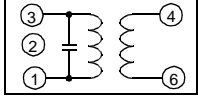
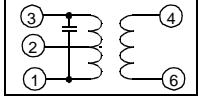
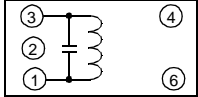
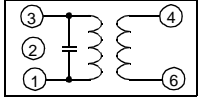
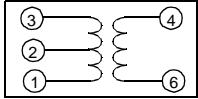
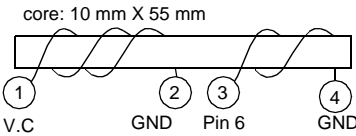
Coil No.	f	Q ₀	Turns		C.L.	Connections (KWANG SUNG PART NO)
T1	10.7MHz	120	1-3	8T	150pF	 <p>KSI-FD5</p>
T2	10.7MHz	70min	1-3	11T	75pF	 <p>KSI-FA2</p>
			4-6	2T		
T3 (T6)	455kHz	80min	1-2	91T	180pF	 <p>KSI-AA4</p>
			2-3	55T		
			4-6	6T		
T4	10.7MHz	45min	1-3	11T	82pF	 <p>KSI-FD4</p>
T5	10.7MHz	45min	1-3	7T	180pF	 <p>KSI-FA4</p>
			4-6	7T		
L1	AM Local Oscillator	90min	1-3	86T		 <p>KSI-AO4</p>
			4-6	7T		
L2	AM ANT	200	1-2 L = 560uH	138T		 <p>KSA-ANT560</p>
			4-6	9T		

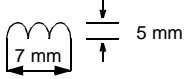
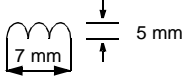
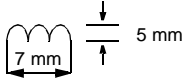
Coil No.	f	Q_0	Turns		C.L.	Connections (KWANG SUNG PART NO)
L3	FM ANT		0.8mm ϕ UEW	5T		 KSS-SP5
		0.5T				
L4	Trap		0.32mm ϕ UEW	10T		 KSS-SP4
L5	FM Oscillator		0.8mm ϕ UEW	4T		 KSS-SP3

COIL SPECIFICATION 2

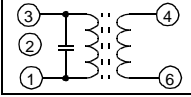
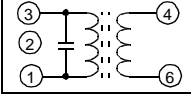
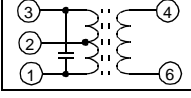
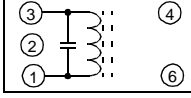
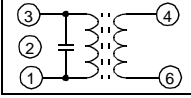
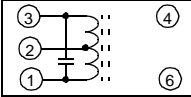
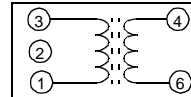
Coil No.	f	Q ₀	Turns		C.L.	Connections
			1-3			
T1	10.7MHz	90	1-3	11	82pF	
			4-6	3		
T2	10.7MHz	60	1-3	5	390pF	
			4-6	2		
T3	455kHz	100	1-2	127	180pF	
			2-3	28		
			4-6	10		
T4	10.7MHz	45 (Min)	1-3	11	82 pF	
T5	10.7MHz	25 (Min)	1-3	7	180pF	
			4-6	7		
T6	455kHz	100	1-2	50	390pF	
			2-3	50		
L6	796kHz	100	1-3	100	360μH	
			4-6	10		

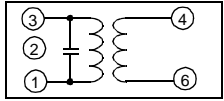
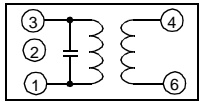
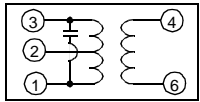
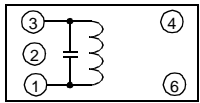
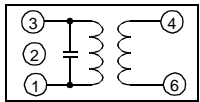
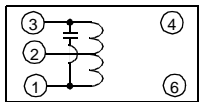
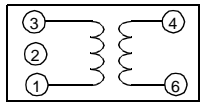
Coil No.	f	Q ₀	Turns		C.L.	Connections (KWANG SUNG PART NO)
			1-3	4-6		
T1	10.7MHz	90	1-3	4-6	82pF	 KSI-FA3
			11	3		
T2	10.7MHz	60	1-3	4-6	390pF	 KSI-FA5
			5	2		
T3	455kHz	100	1-2	127	180pF	 KSI-AA3
			2-3	28		
			4-6	10		
T4	10.7MHz	45min	1-3	11	82pF	 KSI-FD4
T5	10.7MHz	45min	1-3	7	180pF	 KSI-FA4
			4-6	7		
T6	455kHz	100	1-2	50	390pF	 KSI-AA2
			2-3	50		
L6	796kHz	100	1-3	100	360uH	 KSI-A03
			4-6	10		

NOTES