

LC75374E

Electronic Volume and Tone Control for Car Stereos



Overview

The LC75374E is an electronic volume and tone control circuit that provides volume, balance, fader, bass and treble, super bass, input switching, and input and output level controls and requires a minimal number of external components to implement these functions.

Functions

- Volume: 0dB to -79 dB (in 1-dB steps) and $-\infty$ dB for a total of 81 positions.
A balance function can be implemented by controlling the left and right channels independently.
- Fader: Allows either the rear or the front channel outputs to be attenuated over 16 positions.
(0 to -20 dB in 2dB steps, -20 to -25 dB in a 5dB step, -25 to -45 dB in 10dB steps, -60 dB, and $-\infty$ dB for a total of 16 positions.)
- Bass and treble: NF-type tone control circuits are formed using external CR circuits. The bass and treble can be controlled from 0dB to $+11.9$ dB (in 1.7dB steps) for a total of 15 positions.
- Input gain: The input signal can be amplified by 0dB to $+18.75$ dB (in 1.25dB steps).
- Output gain: The fader output can be set to one of three settings: 0dB, $+6.5$ dB, or $+8.5$ dB.
- Input switching: Both the left and right channels can be selected from one of four inputs.
- Super bass: This circuit provides peaking characteristics (T type characteristics) and 11 position settings.

Features

- On-chip buffer amplifiers minimizes the number of external components.
- Built-in reference voltage generator for the analog ground.
- All controls can be set using the serial data input circuit (CCB).

Package Dimensions

unit: mm

3148-QIP44MA

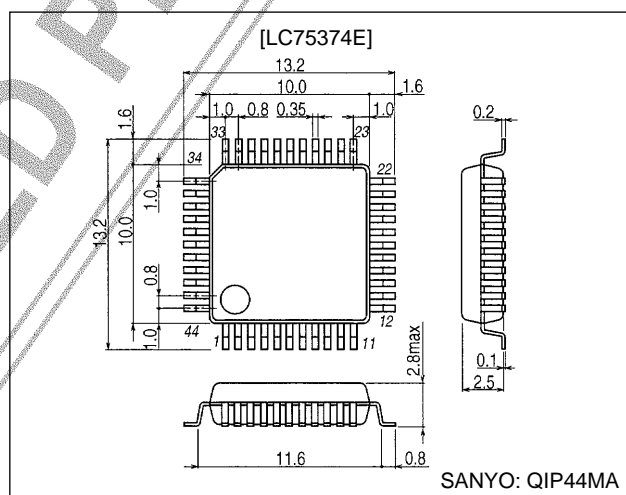

- CCB is a trademark of SANYO ELECTRIC CO., LTD.
- CCB is SANYO's original bus format and all the bus addresses are controlled by SANYO.

■ Any and all SANYO products described or contained herein do not have specifications that can handle applications that require extremely high levels of reliability, such as life-support systems, aircraft's control systems, or other applications whose failure can be reasonably expected to result in serious physical and/or material damage. Consult with your SANYO representative nearest you before using any SANYO products described or contained herein in such applications.

■ SANYO assumes no responsibility for equipment failures that result from using products at values that exceed, even momentarily, rated values (such as maximum ratings, operating condition ranges, or other parameters) listed in products specifications of any and all SANYO products described or contained herein.

SANYO Electric Co., Ltd. Semiconductor Business Headquarters

TOKYO OFFICE Tokyo Bldg., 1-10, 1 Chome, Ueno, Taito-ku, TOKYO, 110-8534 JAPAN

Specifications

Absolute Maximum Ratings at Ta = 25°C, VSS = 0 V

Parameter	Symbol	Conditions	Ratings	Unit
Maximum supply voltage	V _{DD} max	V _{DD}	11	V
Maximum input voltage	V _{IN} max	CL, DI, CE	V _{SS} - 0.3 to V _{DD} + 0.3	V
Allowable power dissipation	Pd max	When Ta ≤ 85°C and mounted on a printed circuit board	720	mW
Operating temperature	Topr		-40 to +85	°C
Storage temperature	Tstg		-50 to +125	°C

Allowable Operating Ranges at Ta = -40 to +85°C, VSS = 0 V

Parameter	Symbol	Conditions	Ratings			Unit
			min	typ	max	
Supply voltage	V _{DD}	V _{DD}	7.5		9.7	V
High-level input voltage	V _{IH}	CL, DI, CE	4.0		V _{DD}	V
Low-level input voltage	V _{IL}	CL, DI, CE	V _{SS}		1.0	V
Input voltage amplitude	V _{IN}	CL, DI, CE, LVRIN, RVRIN, L1 to L4, R1 to R4, LFIN, RFIN, LSIN, RSIN	V _{SS}		V _{DD}	Vp-p
Input pulse width	t _{φW}	CL	1			μs
Setup time	t _{setup}	CL, DI, CE	1			μs
Hold time	t _{hold}	CL, DI, CE	1			μs
Operating frequency	f _{opg}	CL			500	kHz

Electrical Characteristics at Ta = 25°C, VDD = 8 V, VSS = 0 V

Parameter	Symbol	Conditions	Ratings			Unit
			min	typ	max	
[Input Block]						
Maximum input gain	G _{in} max			+18.75		dB
Step resolution	G _{step}			+1.25		dB
Output load resistance	R _L		10			kΩ
Output impedance	R _O	LSEL0, RSEL0 : R _L = 10 kΩ, f = 1 kHz, V _{IN} = 1 Vrms		46		Ω
[Output Block]						
Maximum output gain	G _{out} max			+8.5		dB
Output load resistance	R _L		10			kΩ
Output impedance	R _O	LFOUT, LROUT, RFOUT, RROUT : R _L = 10 kΩ, f = 1 kHz, V _{IN} = 1 Vrms		35		Ω
[Volume Control Block]						
Step resolution	AT _{step}			1		dB
Step error	AT _{err}	STEP = 0 dB to -20 dB	-1	0	+1	dB
		STEP = -20 dB to -50 dB	-3	0	+3	dB
Output load resistance	R _L		10			kΩ
Output impedance	R _O	LTOUT, RTOUT : R _L = 10 kΩ, f = 1 kHz, V _{IN} = 1 Vrms		46		Ω
[Fader Volume Control Block]						
Step resolution	AT _{step}	STEP = 0 dB to -20 dB		2		dB
		STEP = -20 dB to -25 dB		5		dB
		STEP = -25 dB to -45 dB		10		dB
Step error	AT _{err}	STEP = 0 dB to -45 dB	-2	0	+2	dB
		STEP = -45 dB to -60 dB	-3	0	+3	dB
Output load resistance	R _L		10			kΩ
Output impedance	R _O	LFOUT, LROUT, RFOUT, RROUT : R _L = 10 kΩ, f = 1 kHz, V _{IN} = 1 Vrms		46		Ω
[Bass and Treble Control Block]						
Bass control range	G _{bass}	Max. Boost/Cut	±8	±11.9	±13	dB
Treble control range	G _{tre}	Max. Boost/Cut	±8	±11.9	±13	dB
Output load resistance	R _L		10			kΩ
Output impedance	R _O	LTOUT, RTOUT : R _L = 10 kΩ, f = 1 kHz, V _{IN} = 1 Vrms		46		Ω

Continued on next page.

LC75374E

Continued from preceding page.

Electrical Characteristics at $T_a = 25^\circ\text{C}$, $V_{DD} = 8\text{ V}$, $V_{SS} = 0\text{ V}$

Parameter	Symbol	Conditions	Ratings			Unit
			min	typ	max	
[Super-Bass Block] (T type)						
Control range	Crange	Max. Boost		+20		dB
Step resolution	ATstep			+2.0		dB
Output load resistance	R_L		10			$k\Omega$
Output impedance	R_O	LSB2, RSB2 : $R_L = 10\text{ k}\Omega$, $f = 1\text{ kHz}$, $V_{IN} = 1\text{ Vrms}$		70		Ω
[Overall]						
Total harmonic distortion	THD	$V_{IN} = 1\text{ Vrms}$, $f = 1\text{ kHz}$, All controls flat overall		0.003	0.01	%
Crosstalk	CT	$V_{IN} = 1\text{ Vrms}$, $f = 1\text{ kHz}$, All controls flat overall, $R_g = 1\text{ k}\Omega$		80.5		dB
Output at maximum attenuation	V_o min	$V_{IN} = 1\text{ Vrms}$, $f = 1\text{ kHz}$, Main volume setting: $-\infty$		-80		dB
Output noise voltage	V_{N1}	All controls flat overall, (IHF-A), $R_g = 1\text{ k}\Omega$		8		μV
	V_{N2}	All controls flat overall, (DIN-AUDIO), $R_g = 1\text{ k}\Omega$		10		μV
High-level input voltage	I_{IH}	CL, DI, CE, $V_{IN} = 8\text{ V}$			10	μA
Low-level input voltage	I_{IL}	CL, DI, CE, $V_{IN} = 0\text{ V}$	-10			μA

Pin Assignment

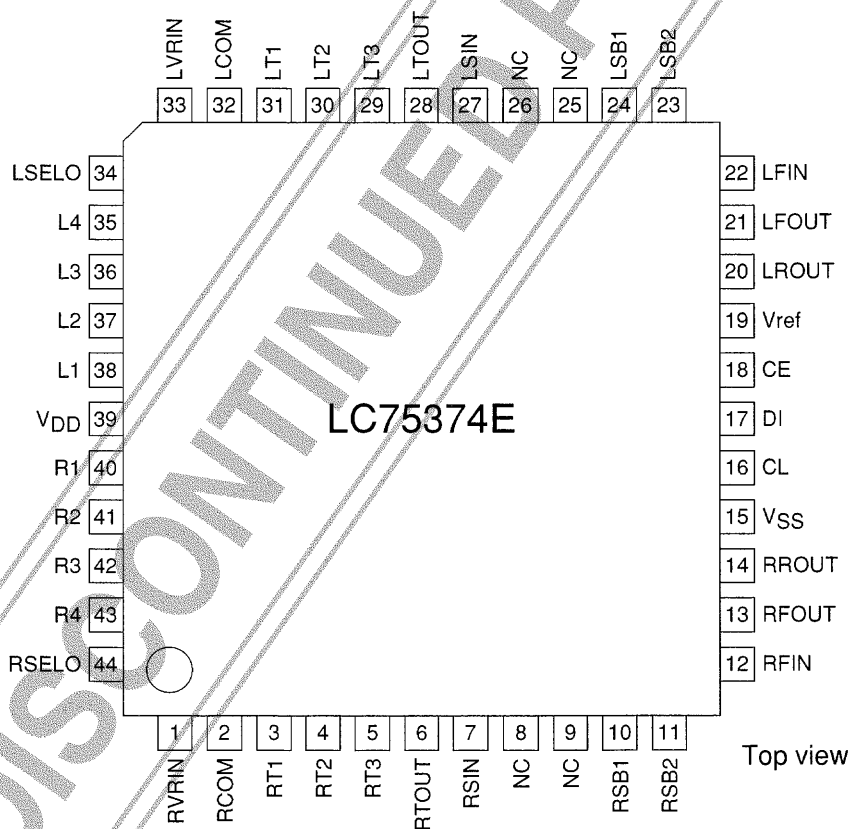

A10540

Equivalent Circuit

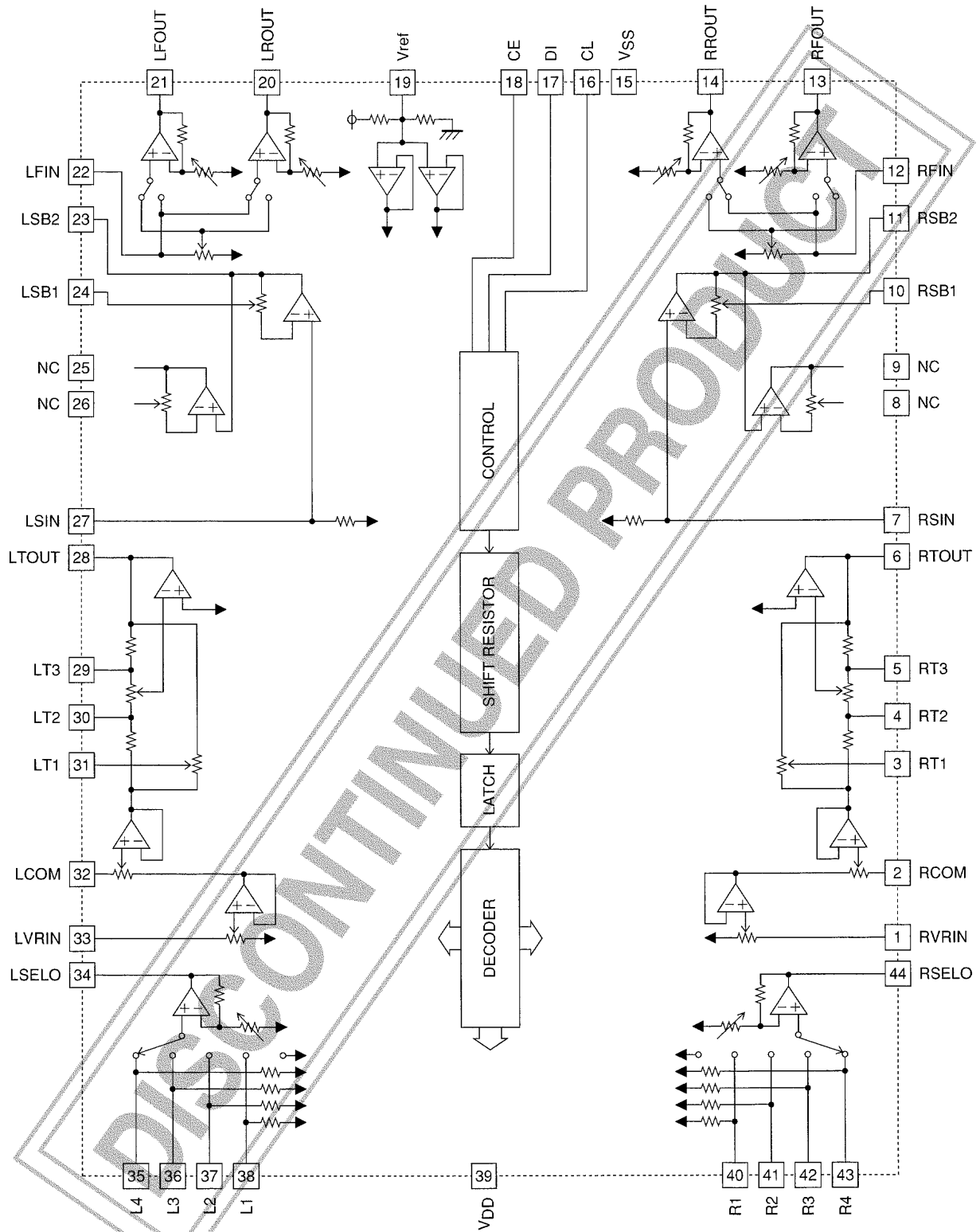

A10541

Control System Timing and Data Format

Applications must input the stipulated serial data to the CE, CL, and DI pins to control the LC75374E. The data consists of a total of 52 bits, of which 8 bits are address and 44 bits are data.

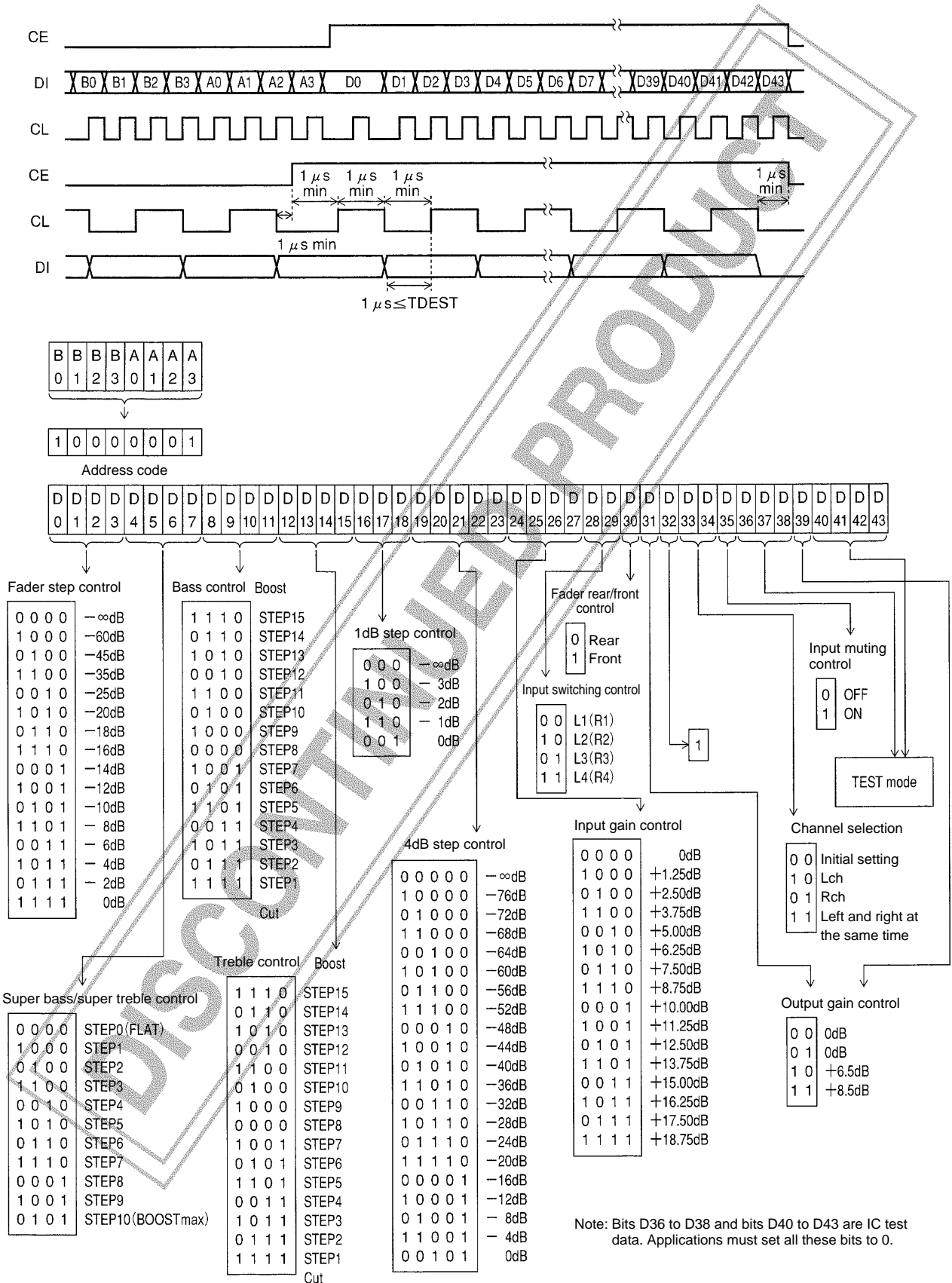

LC75374E

Pin Functions

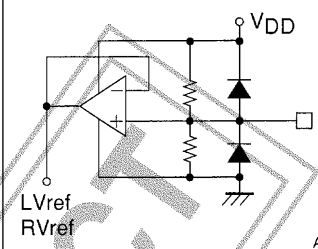
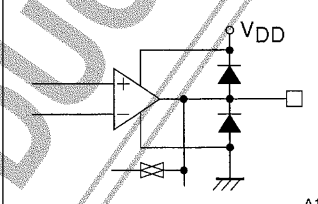
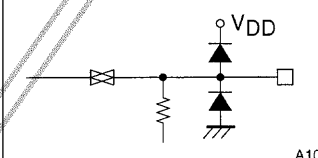
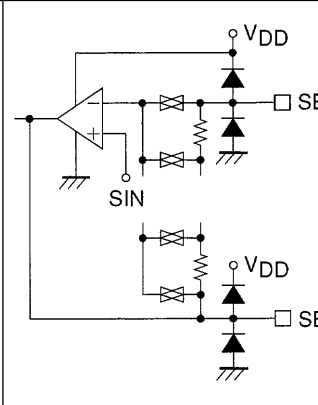
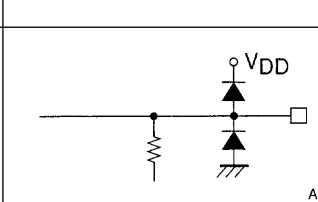
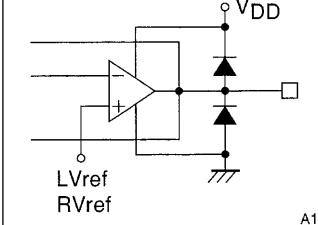
Pin No.	Pin	Description	Notes
19	Vref	<ul style="list-style-type: none"> Supply voltage generator ($0.525 \times V_{DD}$) used for the analog ground. A capacitor must be connected between Vref and V_{SS} to remove power supply ripple. 	 <p>A10543</p>
20 21 14 13	LROUT LFOUT RROUT RFOUT	<ul style="list-style-type: none"> Fader outputs. The front and rear outputs can be attenuated independently. 	 <p>A10544</p>
22 12	LFIN RFIN	<ul style="list-style-type: none"> Fader inputs These inputs must be driven by low-impedance circuits. 	 <p>A10545</p>
24 23 10 11	LSB1 LSB2 RSB1 RSB2	<ul style="list-style-type: none"> Left channel super bass compensation capacitor connection Left channel super bass output and compensation capacitor connection Right channel super bass compensation capacitor connection Right channel super bass output and compensation capacitor connection 	 <p>A10547</p>
22 7	LSIN RSIN	<ul style="list-style-type: none"> Super bass input These inputs must be driven by low-impedance circuits. 	 <p>A10548</p>
28 6	LTOUT RTOUT	<ul style="list-style-type: none"> Tone control outputs 	 <p>A10549</p>

Continued on next page.

LC75374E

Continued from preceding page.

Pin No.	Pin	Description	Notes
31 30 29 3 4 5	LT1 LT2 LT3 RT1 RT2 RT3	<ul style="list-style-type: none"> Tone control circuit bass and treble compensation capacitor connections. Connect the high band compensation capacitors between the pins T1 and T2. Connect the low band compensation capacitors between the pins T2 and T3. 	<p>A10550</p>
32 2	LCOM RCOM	<ul style="list-style-type: none"> 1dB volume control common connections 	<p>A10551</p>
33 1	LVRIN RVRIN	<ul style="list-style-type: none"> 4dB volume control inputs These inputs must be driven by low-impedance circuits. 	<p>A10552</p>
34 44	LSEL0 RSEL0	<ul style="list-style-type: none"> Input selector outputs 	<p>A10553</p>
38 37 36 35 40 41 42 43	L1 L2 L3 L4 R1 R2 R3 R4	<ul style="list-style-type: none"> Signal inputs 	<p>A10554</p>
39	V _{DD}	<ul style="list-style-type: none"> Power supply 	
15	V _{SS}	<ul style="list-style-type: none"> Ground 	
16 17	CL DI	<ul style="list-style-type: none"> Serial data and clock inputs used for transferring control data 	
18	CE	<ul style="list-style-type: none"> Chip enable input. Data is written into the internal latches and the analog switches operate when this pin goes from high to low. Data transfers are enabled when this pin is high. 	<p>A10555</p>
8, 26 9, 25	NC	<ul style="list-style-type: none"> Unused pins. These pins must be connected to V_{SS}. Unused pins. These pins must be left open. 	

LC75374E

Input Block Equivalent Circuit

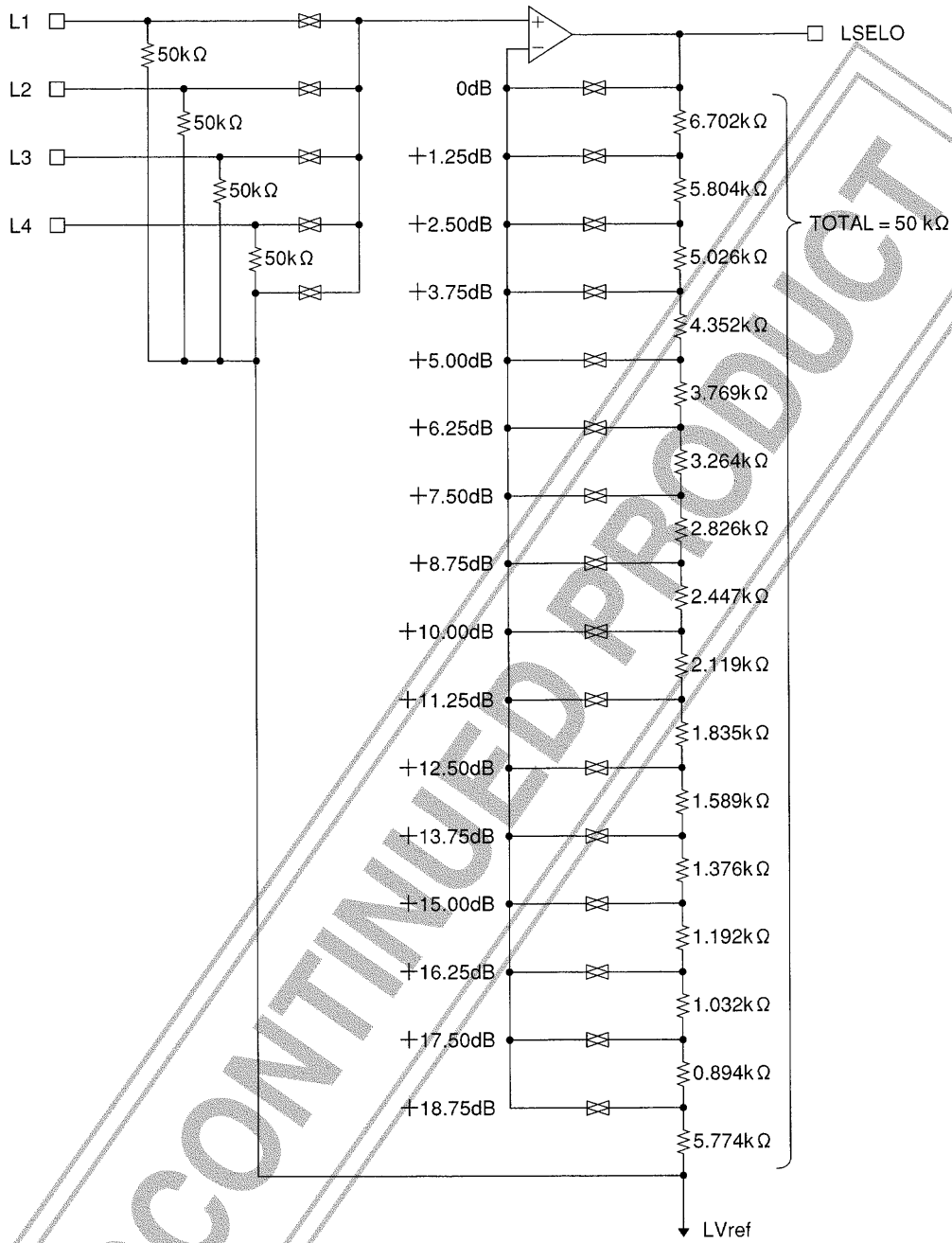

A10556

The right channel is identical.

DISCONTINUED PRODUCT

Main Volume Control Block Equivalent Circuit

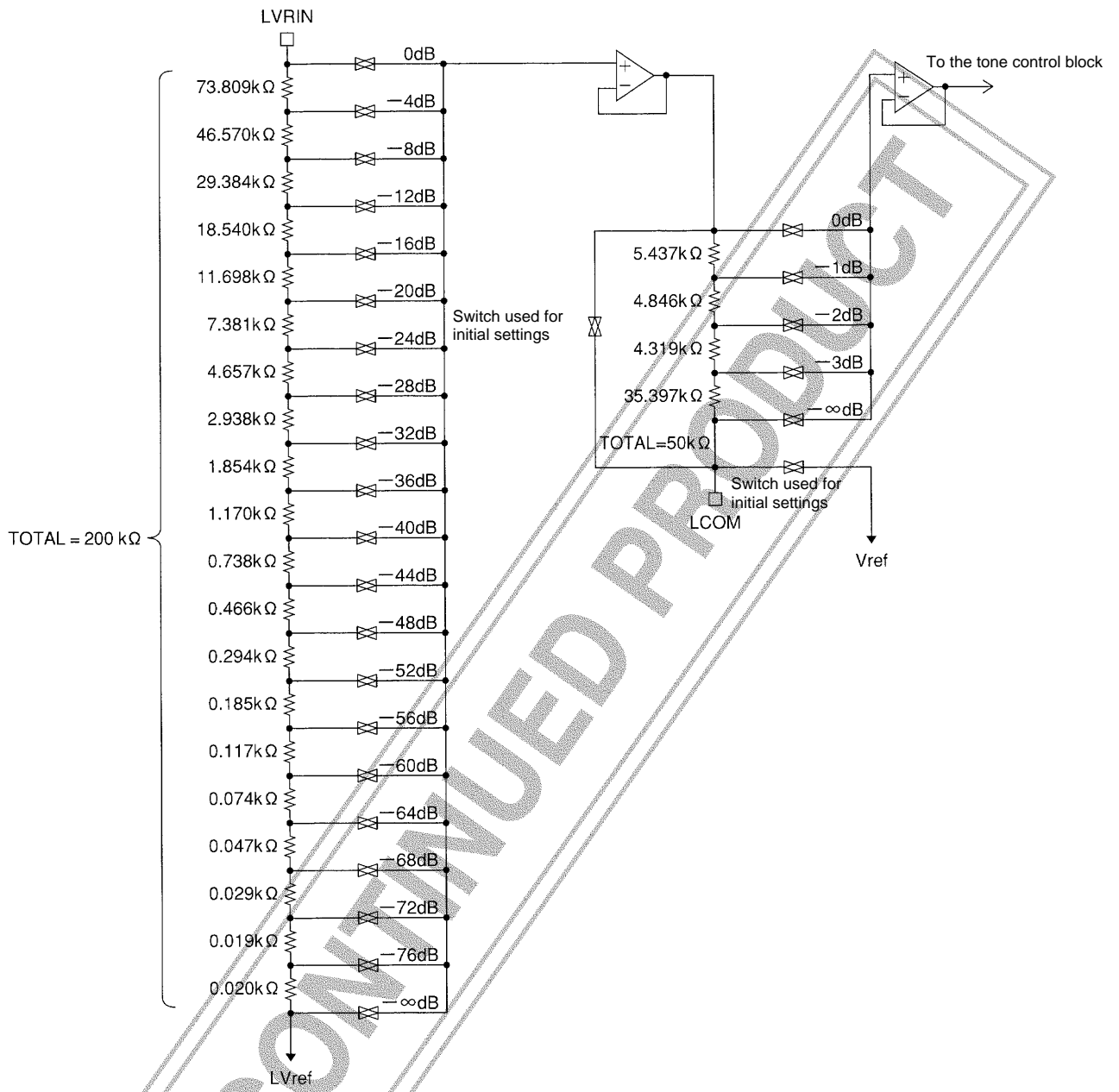

TOTAL = 200 kΩ

DISCONTINUED PRODUCT

A10557

The right channel is identical.

Tone Block Equivalent Circuit

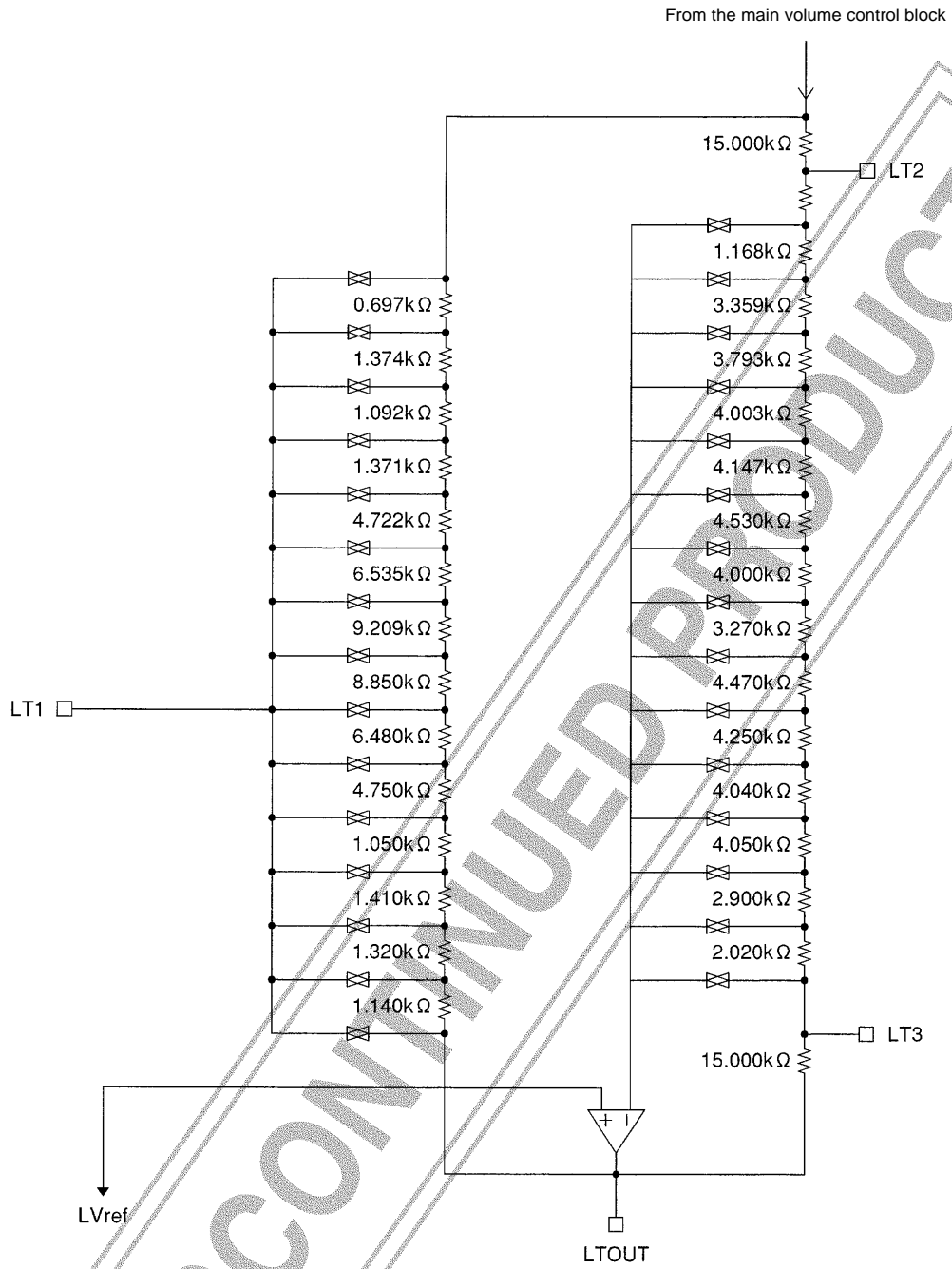

A10558

The right channel is identical.

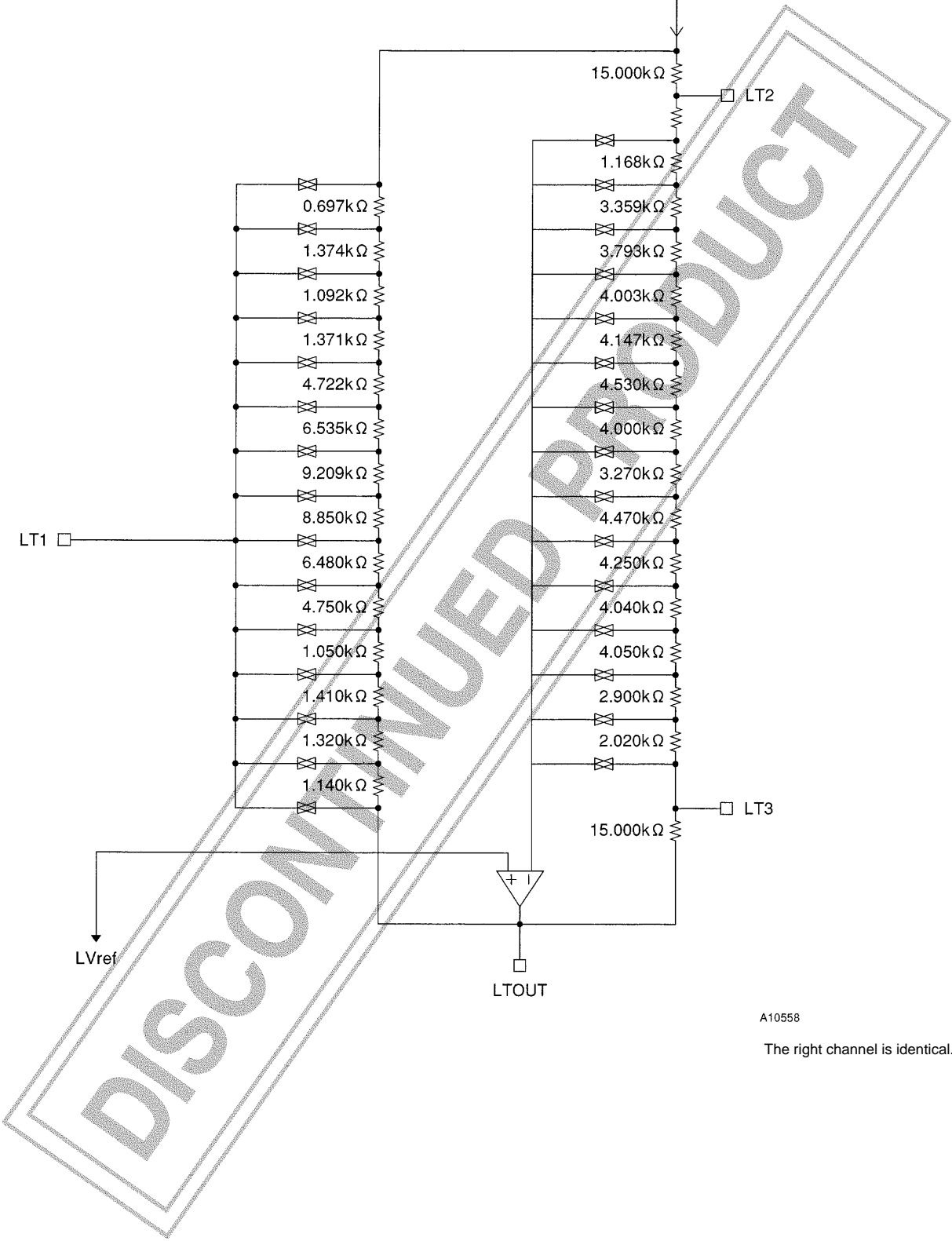

Super Bass Block Equivalent Circuit

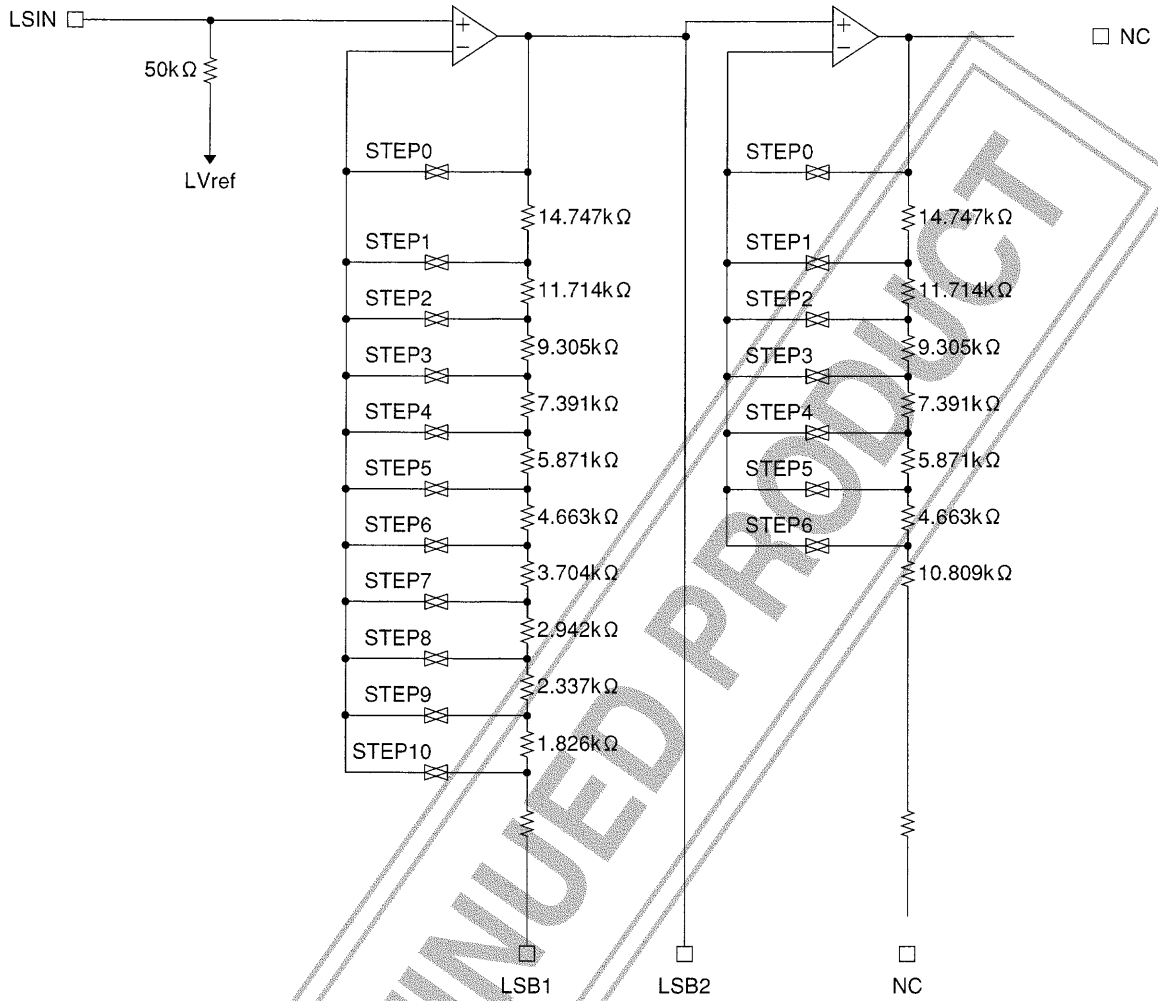

A10559

The right channel is identical.

DISCONTINUED PRODUCT

Sample external constant calculations for the super bass (T type) circuit when full boost is used

The external constants required when full boost is used with the super bass block (T type) are calculated as follows.

- Super bass (T type) equivalent circuit

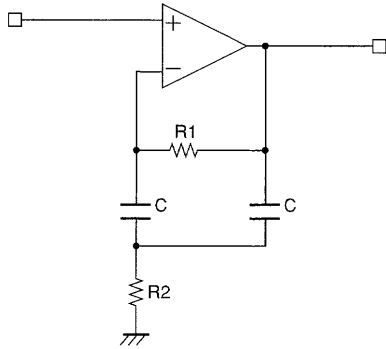

A10560

Sample calculation

Assume:

R1 = 64.5 kΩ, and

G = 20.65 dB, and

f0 = 72.7 Hz.

- Calculation

(1) Center frequency

$$f_0 = \frac{1}{2 \times \pi \times \sqrt{R_1 \times R_2 \times C \times C}}$$

(2) Gain

$$G = 20 \log \left(1 + \frac{R_1}{2 \times R_2} \right)$$

(3) Q

$$Q = \frac{C \times C \times R_1}{2 \times C} \times \frac{1}{\sqrt{R_1 \times R_2 \times C \times C}}$$

- Determine R2

Determine R2 from formula (2).

$$R_2 = \frac{64.5}{2 \times (10.78 - 1)} \approx 3.3 \text{ (k}\Omega\text{)}$$

- Determine C

Determine C from formula (1).

$$C = \frac{1}{\sqrt{R_1 \times R_2 \times (2 \times \pi \times f_0) \times (2 \times \pi \times f_0)}} \approx 0.15 \text{ (}\mu\text{F)}$$

- Determine Q

Determine Q from formula (3).

Here, Q will be 2.21.

Fader Volume Control Block Equivalent Circuit

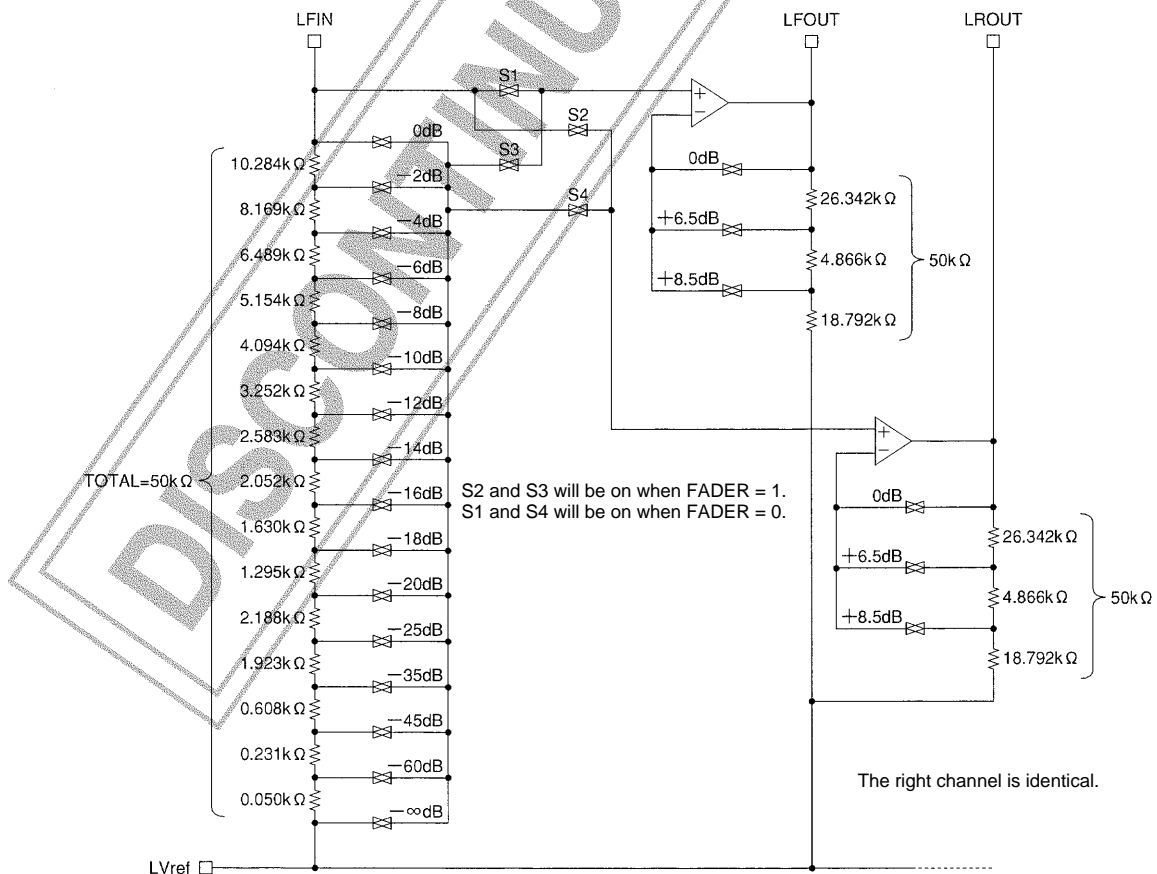

S2 and S3 will be on when FADER = 1.
S1 and S4 will be on when FADER = 0.

The right channel is identical.

A10561

At the point that data corresponding to $-\infty$ is transferred to the 1dB -step main volume control block, S1 and S2 will go to the open state. S3 and S4 will go to the on state at the same time.

Sample Application Circuit

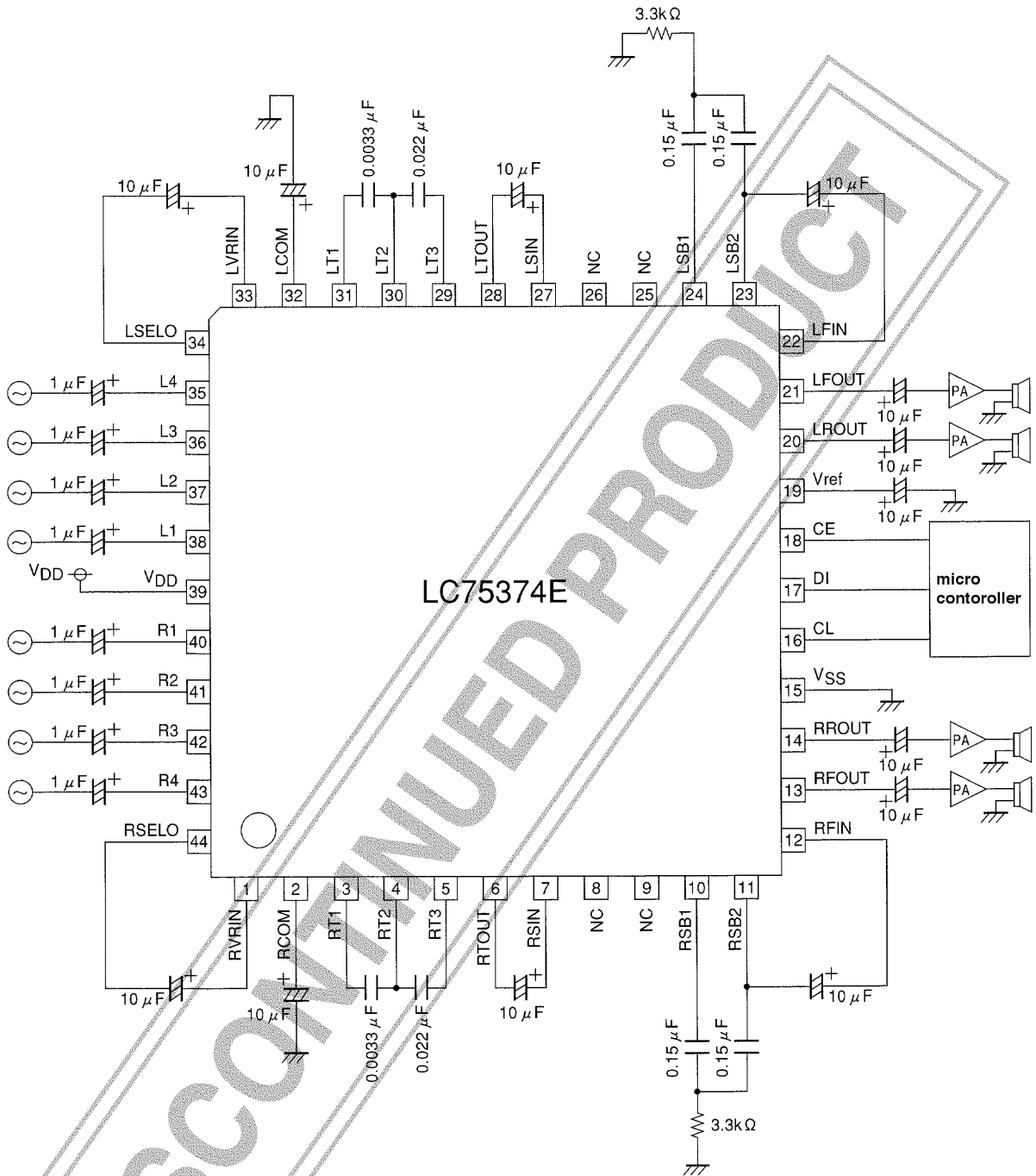

A10562

Usage Notes

- The internal analog switches are in undefined states when power is first applied. Applications must therefore use external circuits to mute the output until control data has been transferred.
- When setting up the initial data after power is first applied, applications must first transfer a set of IC initialization data. This initialization data consists of an address field of (10000001) and a data field of all zeros (D0 to D43 = 0). Applications must only send the actual initial data after this initialization data has been sent.
- Applications must either cover the CL, DI, and CE lines with the ground pattern or use shielded cables for these lines to prevent the high-frequency digital signals that are transmitted over these lines from entering the analog signal system.

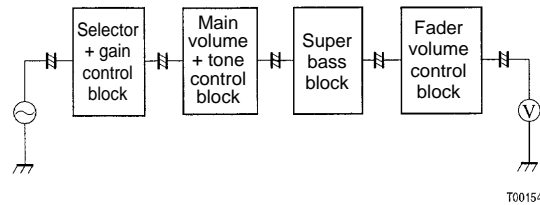
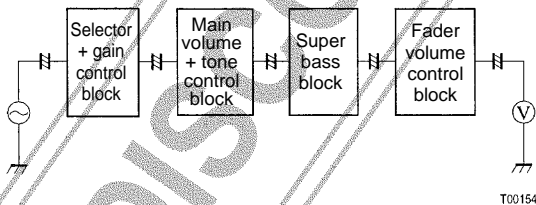
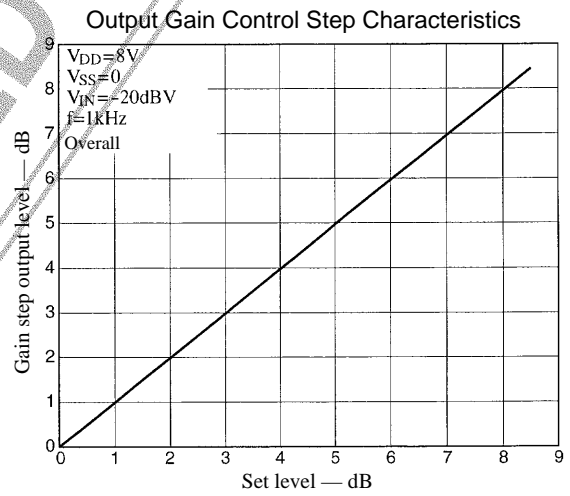
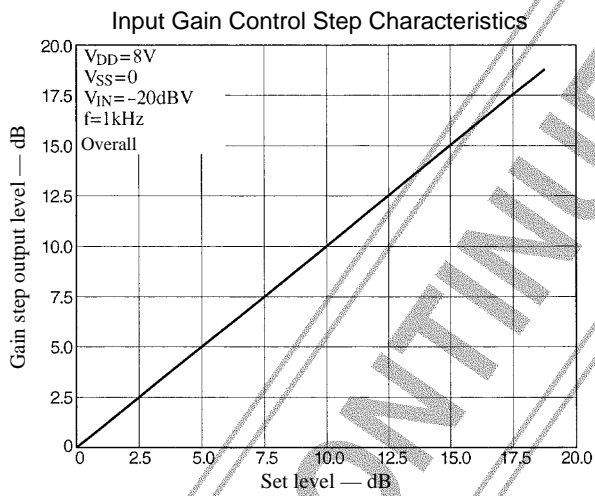
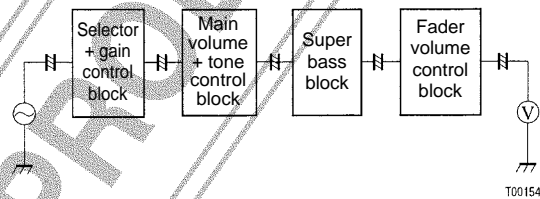
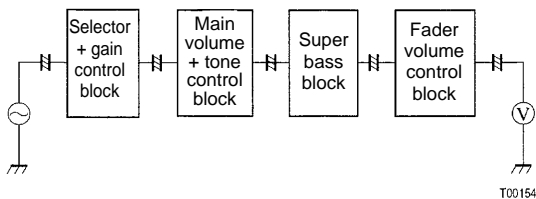
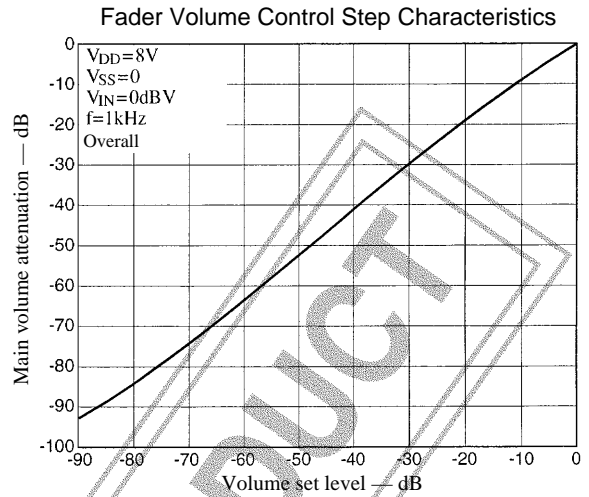
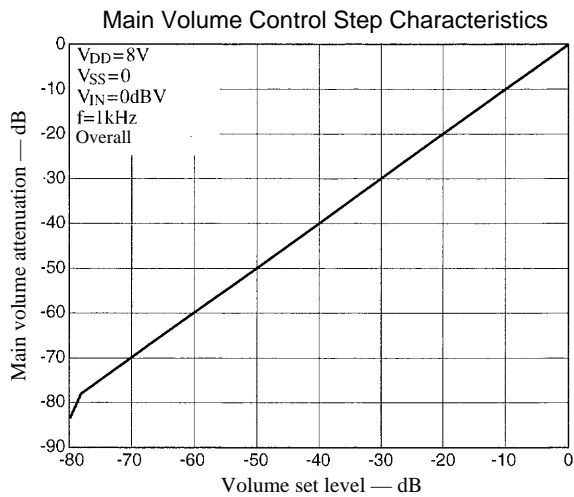

Total Harmonic Distortion - Frequency Characteristics

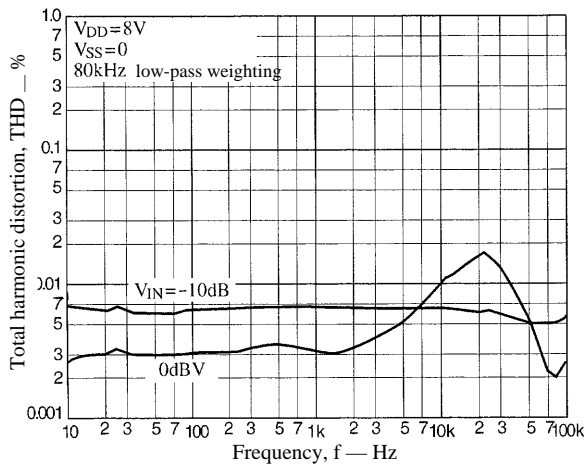

Total Harmonic Distortion - Input Level Characteristics

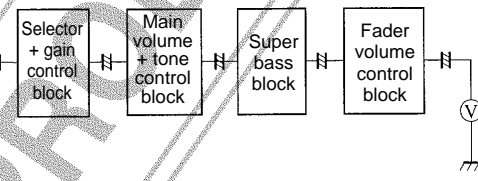
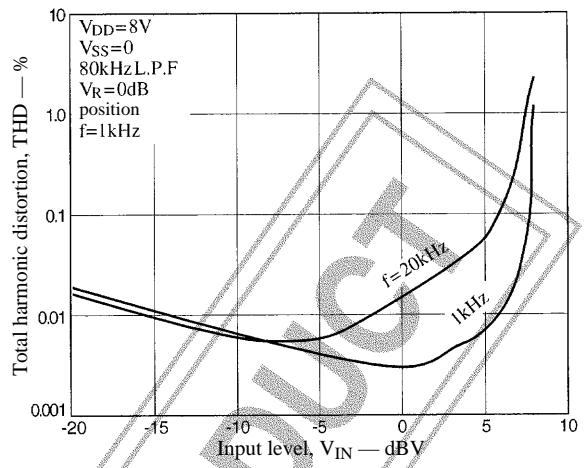

T00154

Total Harmonic Distortion - Supply Voltage Characteristics (1)

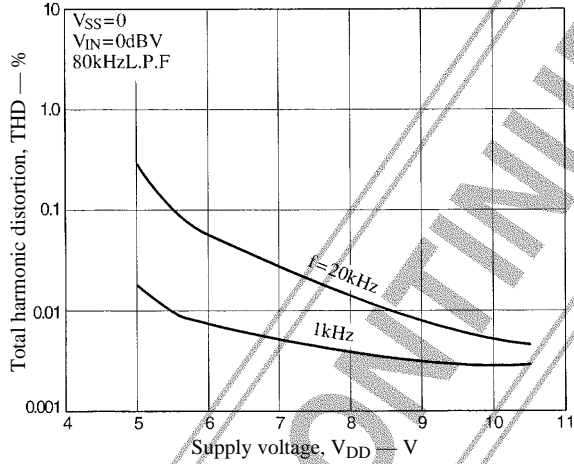

Total Harmonic Distortion - Supply Voltage Characteristics (2)

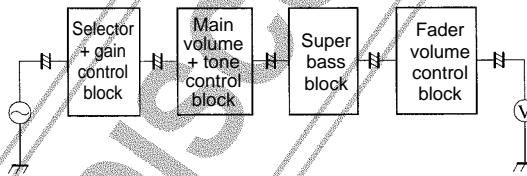
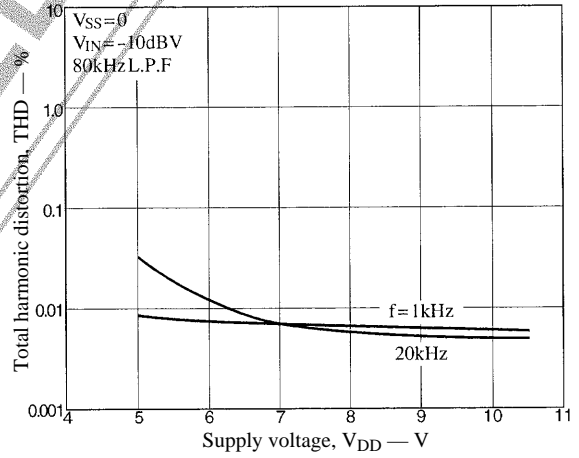

T00154

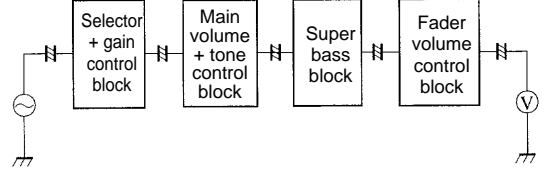

T00154

Total Harmonic Distortion – Main Volume Control Step Characteristics

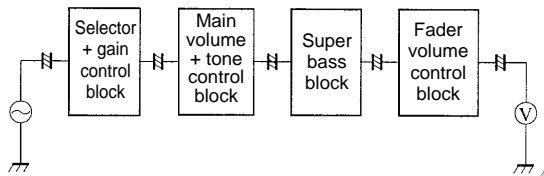
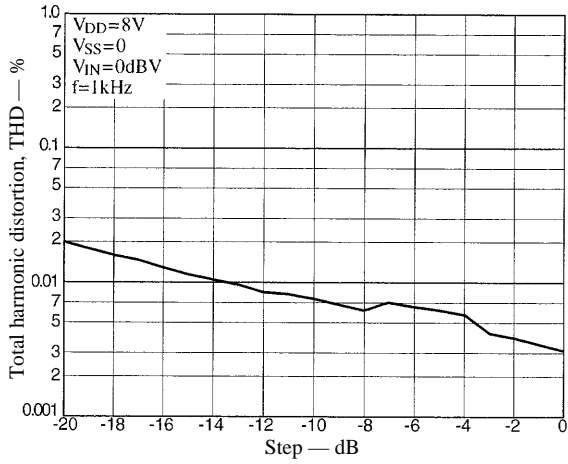

T00154

Super Bass Characteristics

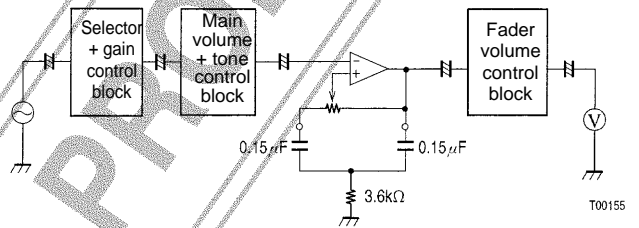
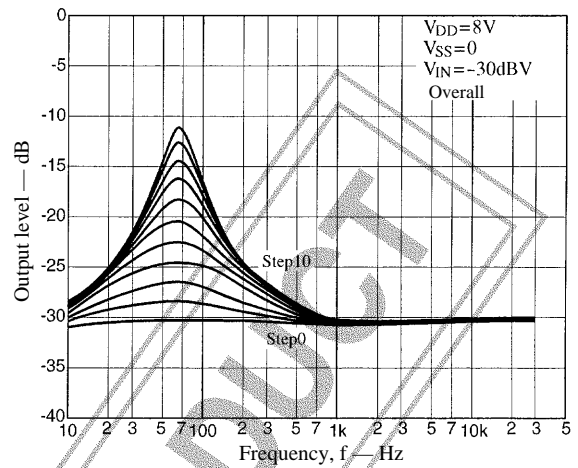

T00155

Bass Characteristics

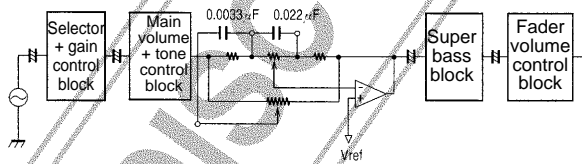
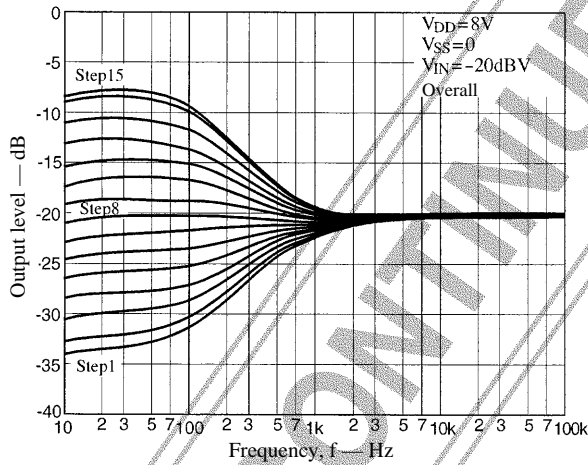

T00156

Treble Characteristics

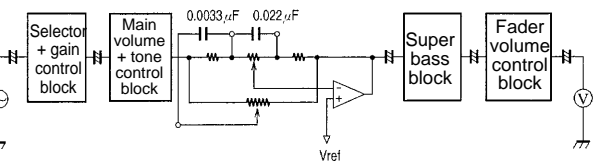
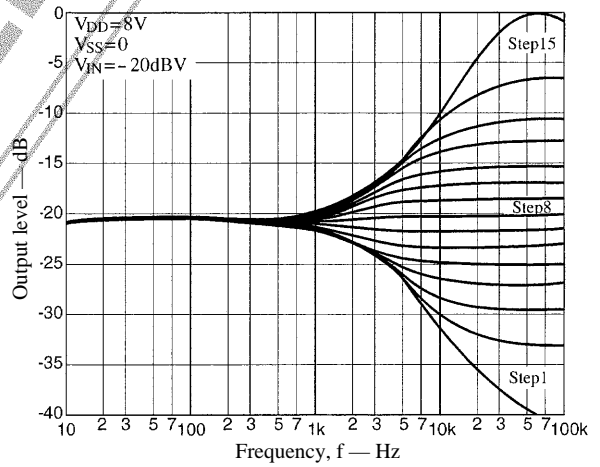

T00156

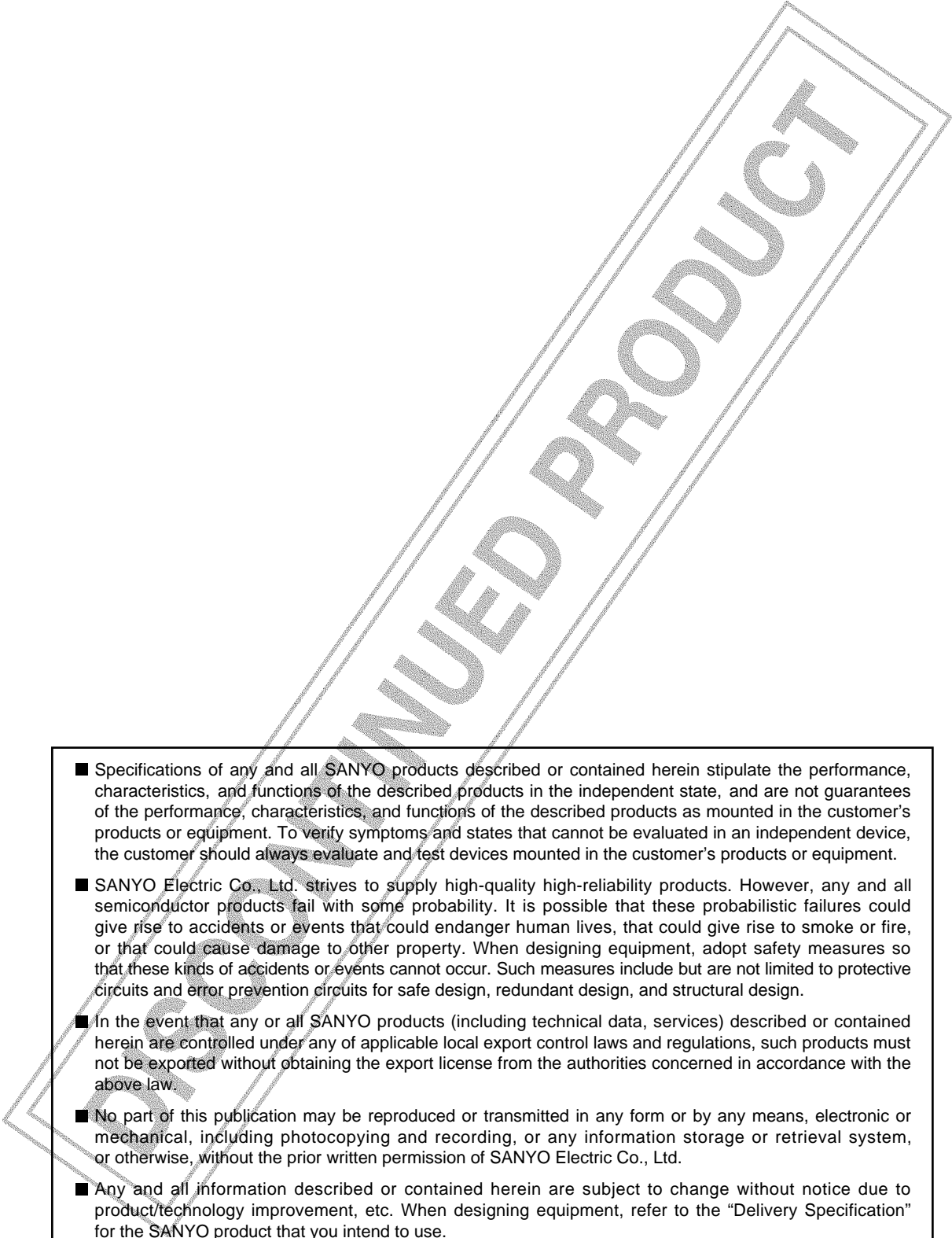
- 
- Specifications of any and all SANYO products described or contained herein stipulate the performance, characteristics, and functions of the described products in the independent state, and are not guarantees of the performance, characteristics, and functions of the described products as mounted in the customer's products or equipment. To verify symptoms and states that cannot be evaluated in an independent device, the customer should always evaluate and test devices mounted in the customer's products or equipment.
 - SANYO Electric Co., Ltd. strives to supply high-quality high-reliability products. However, any and all semiconductor products fail with some probability. It is possible that these probabilistic failures could give rise to accidents or events that could endanger human lives, that could give rise to smoke or fire, or that could cause damage to other property. When designing equipment, adopt safety measures so that these kinds of accidents or events cannot occur. Such measures include but are not limited to protective circuits and error prevention circuits for safe design, redundant design, and structural design.
 - In the event that any or all SANYO products (including technical data, services) described or contained herein are controlled under any of applicable local export control laws and regulations, such products must not be exported without obtaining the export license from the authorities concerned in accordance with the above law.
 - No part of this publication may be reproduced or transmitted in any form or by any means, electronic or mechanical, including photocopying and recording, or any information storage or retrieval system, or otherwise, without the prior written permission of SANYO Electric Co., Ltd.
 - Any and all information described or contained herein are subject to change without notice due to product/technology improvement, etc. When designing equipment, refer to the "Delivery Specification" for the SANYO product that you intend to use.
 - Information (including circuit diagrams and circuit parameters) herein is for example only; it is not guaranteed for volume production. SANYO believes information herein is accurate and reliable, but no guarantees are made or implied regarding its use or any infringements of intellectual property rights or other rights of third parties.

This catalog provides information as of November, 1998. Specifications and information herein are subject to change without notice.