

SANYO**LA4613****Audio Power Amplifier for
Radio Cassette Recorders****Overview**

This is a different-package version of the power amplifier LA4600 with ultralow peripheral component count. Basic power supply spec is $V_{CC} = 15V$. BS capacitor, NF capacitor, and oscillation prevention CR components are incorporated into the IC circuitry.

Functions

- Output power : $V_{CC}=15V/3\Omega \dots 7.0W \times 2$
- Built-in standby switch
- Built-in overheat protection (TSD)

Package Dimensions

unit: mm

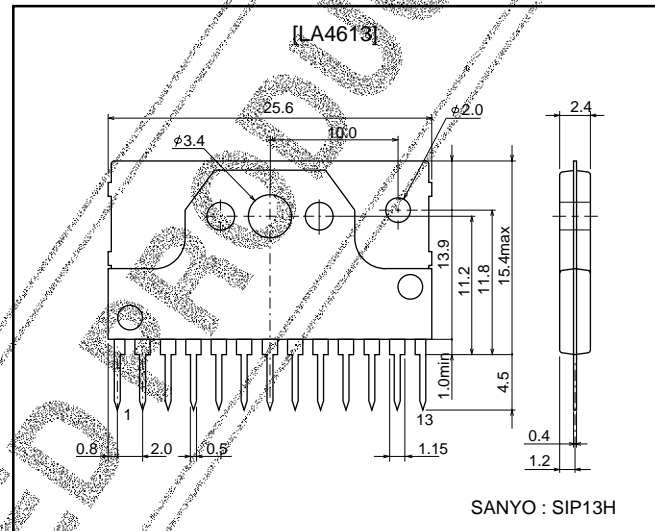
3107-SIP13H**Specifications****Maximum Ratings at $T_a = 25^\circ C$**

Parameter	Symbol	Conditions	Ratings	Unit
Maximum supply voltage	$V_{CC\max}$	$R_g=0$ (No signal)	24	V
Allowable power dissipation	$P_d\max$	With an arbitrary large heatsink	15.0	W
Thermal resistance	θ_{j-c}		3.0	$^\circ C/W$
Operating temperature	T_{opr}		- 20 to +75	$^\circ C$
Storage temperature	T_{stg}		- 40 to +150	$^\circ C$

■ Any and all SANYO products described or contained herein do not have specifications that can handle applications that require extremely high levels of reliability, such as life-support systems, aircraft's control systems, or other applications whose failure can be reasonably expected to result in serious physical and/or material damage. Consult with your SANYO representative nearest you before using any SANYO products described or contained herein in such applications.

■ SANYO assumes no responsibility for equipment failures that result from using products at values that exceed, even momentarily, rated values (such as maximum ratings, operating condition ranges, or other parameters) listed in products specifications of any and all SANYO products described or contained herein.

SANYO Electric Co., Ltd. Semiconductor Business Headquarters

TOKYO OFFICE Tokyo Bldg., 1-10, 1 Chome, Ueno, Taito-ku, TOKYO, 110-8534 JAPAN

LA4613

Recommended Operating Conditions at $T_a = 25^\circ\text{C}$

Parameter	Symbol	Conditions	Ratings	Unit
Recommended supply voltage	V_{CC}		15	V
Recommended load resistance	R_L		3	Ω
Operating supply voltage range	$V_{CC\text{ op}}$	Within maximum ratings	5.0 to 22	V
Operating load resistance range			2.7 to 8	Ω

Electrical Characteristics at $T_a = 25^\circ\text{C}$, $V_{CC} = 15\text{V}$, $R_L = 3\Omega$, $f = 1\text{kHz}$

Parameter	Symbol	Conditions	Ratings			Unit
			min	typ	max	
Standby current	I_{st}	Standby pin \rightarrow GND	—	1.0	10	μA
Quiescent current	I_{CC0}	$R_g=0$	20	35	70	mA
Voltage gain	VG	$V_o=0\text{ dBm}$	43.0	45.0	47.0	dB
Total harmonic distortion	THD	$P_o=1\text{w}$	—	0.2	0.8	%
Output noise voltage	V_{no}	$R_g=0$, DIN AUDIO	—	0.15	0.5	mV
Output voltage	P_{o1}	THD=10%	6.0	7.0	—	W
	P_{o2}	$V_{CC}=9\text{V}$, $R_L=4\Omega$, THD=10%	1.5	2.0	—	W
Channel separation	Chsep	$V_o=0\text{ dBm}$, $R_g=0$, DIN AUDIO	50	60	—	dB
Ripple rejection ratio	SVRR	$V_r=0\text{ dBm}$, $R_g=0$, $f=100\text{ Hz}$ DIN AUDIO	45	55	—	dB
Standby ON voltage	V_{st}		1.5	5.0	—	V
Input resistance	R_i		20	30	40	$\text{k}\Omega$

Block Diagram

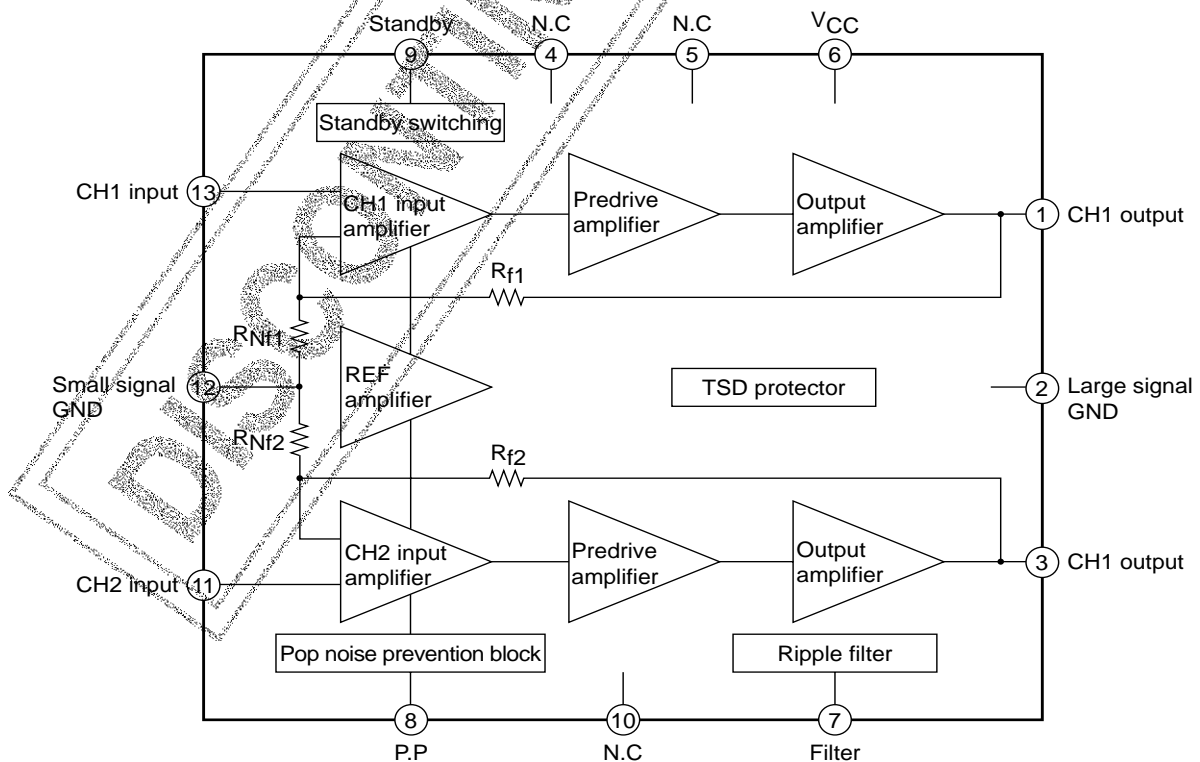

LA4613

Sample Application

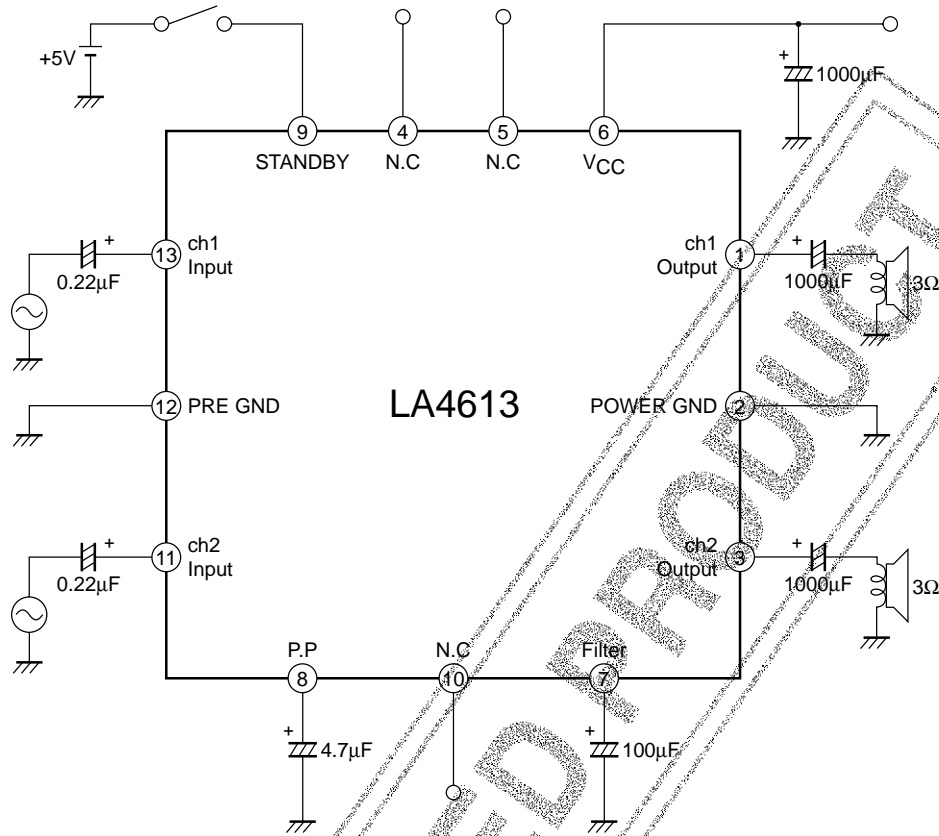

A11492

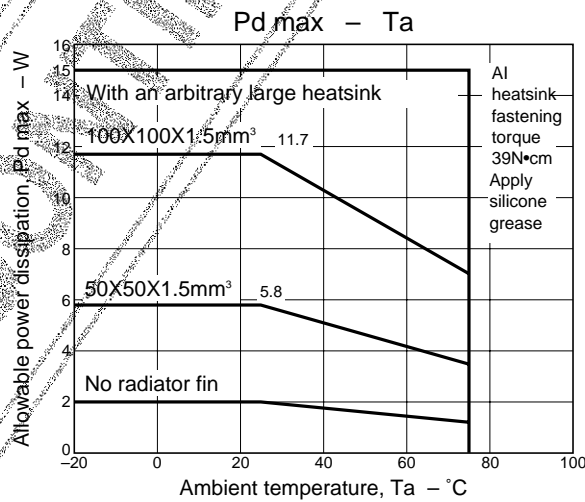

Pin Descriptions

1. Standby switching function (9)

Power is switched ON and OFF by controlling the High and Low states at pin 9, respectively (standby). To switch power ON, apply 1.5V or more, or 800 μ A to pin 9.

$$\text{Current supplied to pin 9} \doteq \frac{\text{Applied voltage}}{2 \text{ k}\Omega} + \frac{\text{Applied voltage} - V_{BE} \text{ (approx. 0.7V)}}{2 \text{ k}\Omega}$$

- When directly connecting the microcontroller with this pin, add a resistor in series to optimize the current for the microcontroller.

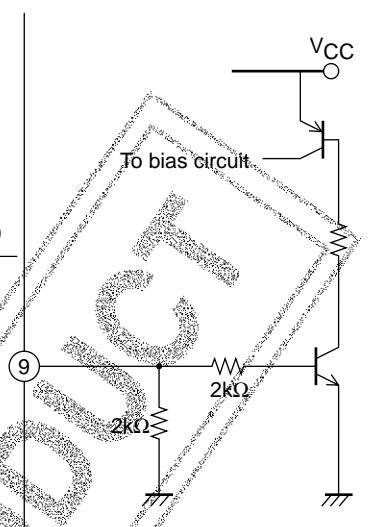

2. Input pins (11,13)

Voltage at the input pins is approx. $2 V_{BE}$ (1.4V).

Input impedance is approx. 30 k Ω .

- The recommended value for the input capacitor is 0.22 μ F, but this can be varied in order to adjust the starting time (t_s). (The starting time is the time required from applying voltage to the standby pin until sound output is obtained.)

Input capacitor	1.0 μ F	2.2 μ F	3.3 μ F	4.7 μ F	10 μ F
Starting time t_s	0.2s	0.3s	0.5s	0.65s	1.5s

3. Filter (decoupling) pin (7)

Pin voltage is approx. $1/2 V_{CC}$.

The recommended value for the filter capacitor is 100 μ F.

When capacitance is lower, pop noise when setting the standby pin to Low (power OFF) will increase.

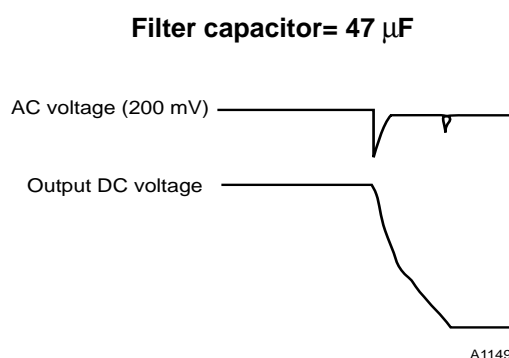
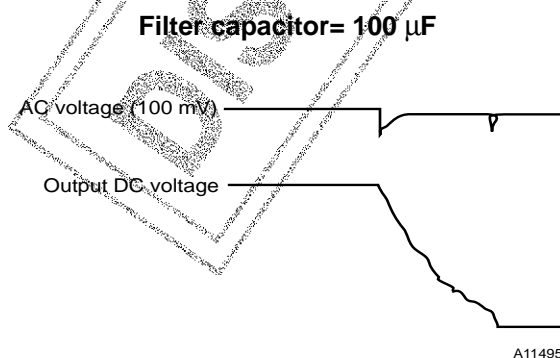

4. P.P (pop noise) pin (8)

$$\text{Voltage at pin 8} \approx \frac{V_{CC} - V_{CE} (\text{approx. } 0.3V) - 5.6V}{2} + 5.6V$$

- The recommended value for the P.P capacitor is 4.7 μF. When capacitance is lower than 2.2 μF, pop noise when setting the standby pin to Low (power OFF) will increase.

When capacitance is higher than 10 μF, the sound will not be cut off when setting the standby pin to Low (power OFF).

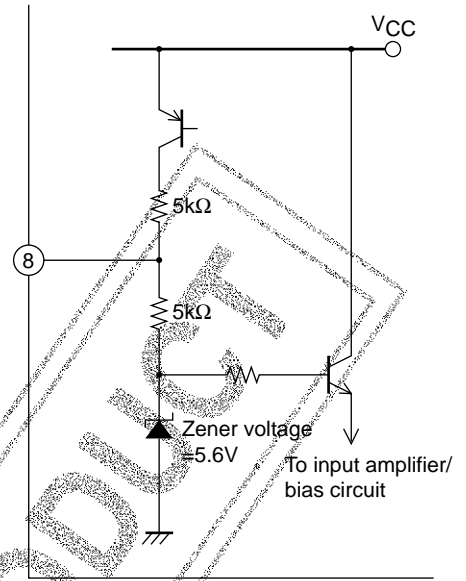

A11497

5. Muting

The output signal can be controlled by connecting pin 7 (Filter) to ground via a resistance of 300 to 500 Ω. If resistance is higher than 750 Ω, the suppression ratio will decrease.

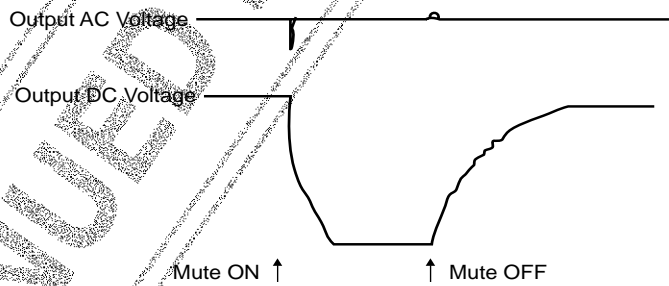

A11498

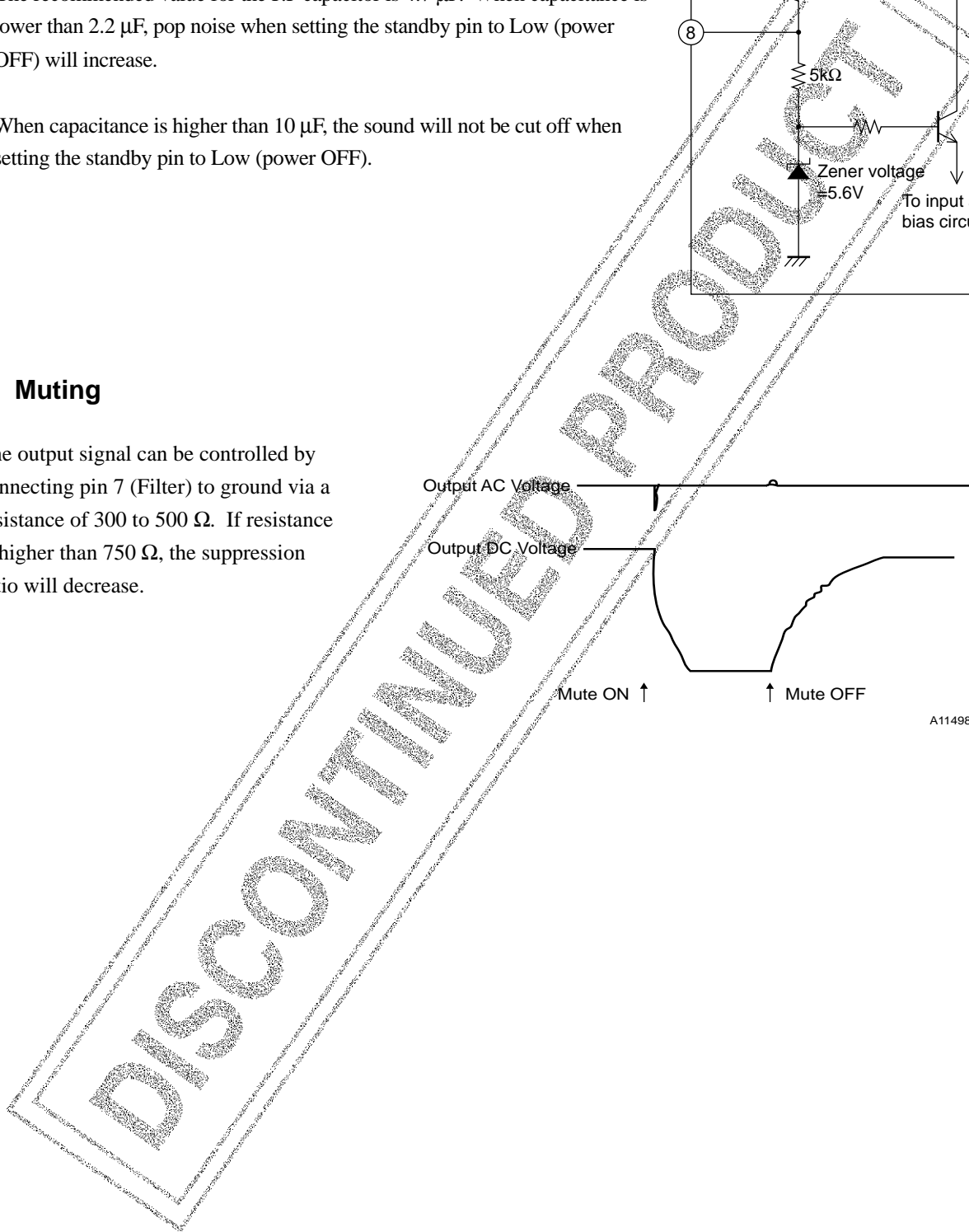

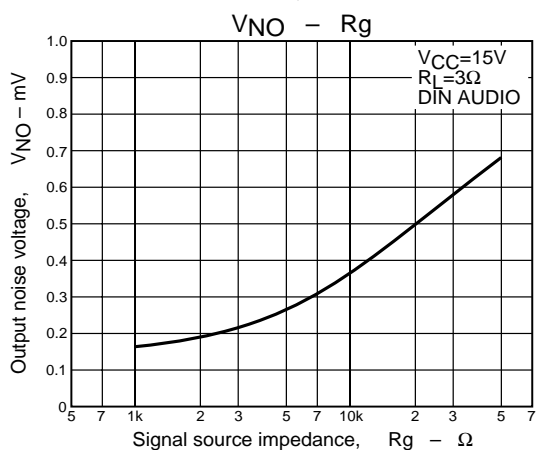
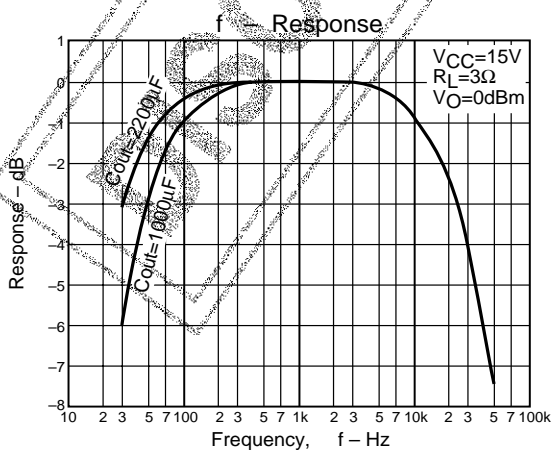
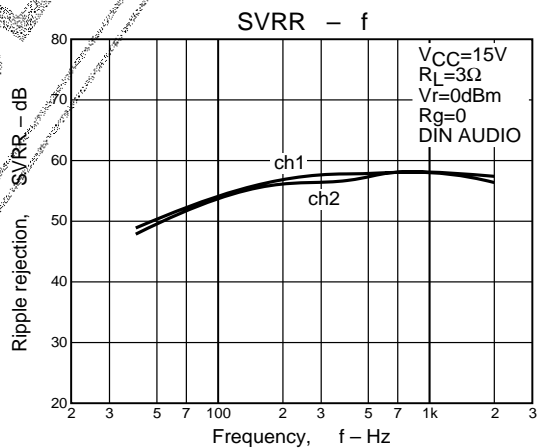
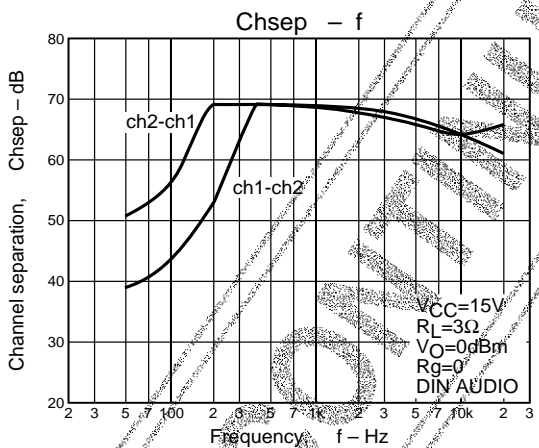
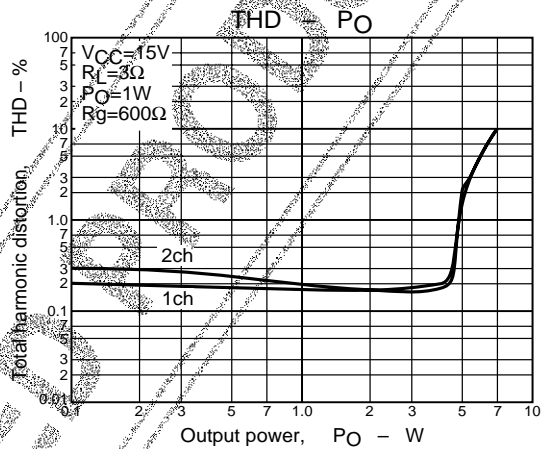
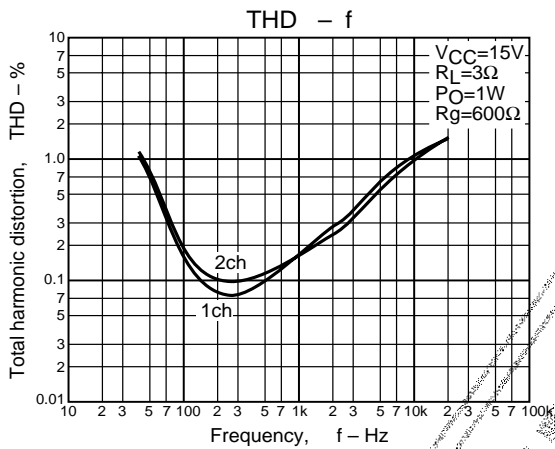
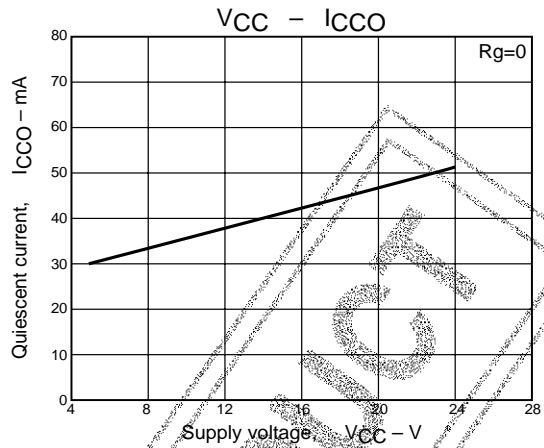
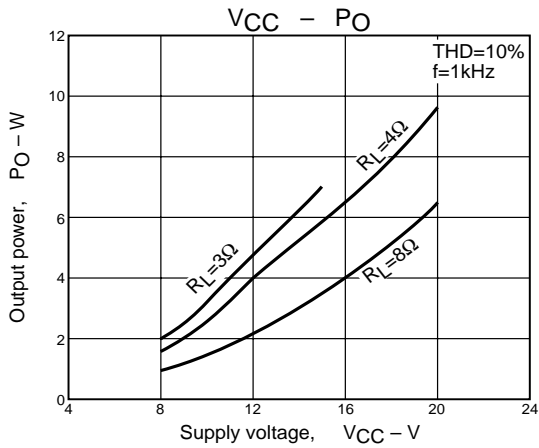

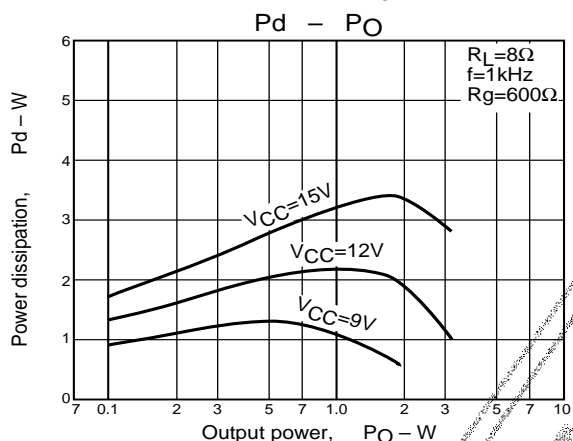
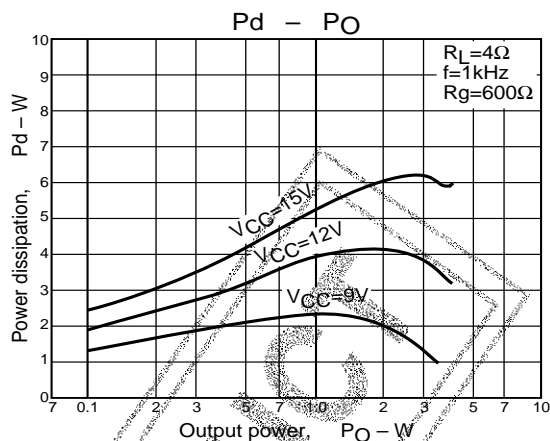
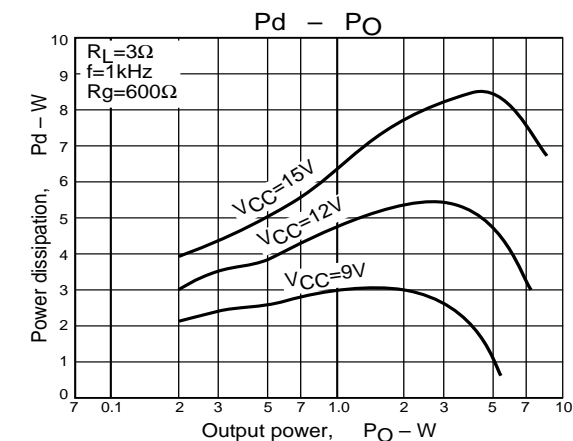

- Specifications of any and all SANYO products described or contained herein stipulate the performance, characteristics, and functions of the described products in the independent state, and are not guarantees of the performance, characteristics, and functions of the described products as mounted in the customer's products or equipment. To verify symptoms and states that cannot be evaluated in an independent device, the customer should always evaluate and test devices mounted in the customer's products or equipment.
- SANYO Electric Co., Ltd. strives to supply high-quality high-reliability products. However, any and all semiconductor products fail with some probability. It is possible that these probabilistic failures could give rise to accidents or events that could endanger human lives, that could give rise to smoke or fire, or that could cause damage to other property. When designing equipment, adopt safety measures so that these kinds of accidents or events cannot occur. Such measures include but are not limited to protective circuits and error prevention circuits for safe design, redundant design, and structural design.
- In the event that any or all SANYO products (including technical data, services) described or contained herein are controlled under any of applicable local export control laws and regulations, such products must not be exported without obtaining the export license from the authorities concerned in accordance with the above law.
- No part of this publication may be reproduced or transmitted in any form or by any means, electronic or mechanical, including photocopying and recording, or any information storage or retrieval system, or otherwise, without the prior written permission of SANYO Electric Co., Ltd.
- Any and all information described or contained herein are subject to change without notice due to product/technology improvement, etc. When designing equipment, refer to the "Delivery Specification" for the SANYO product that you intend to use.
- Information (including circuit diagrams and circuit parameters) herein is for example only; it is not guaranteed for volume production. SANYO believes information herein is accurate and reliable, but no guarantees are made or implied regarding its use or any infringements of intellectual property rights or other rights of third parties.

This catalog provides information as of November, 1998. Specifications and information herein are subject to change without notice.