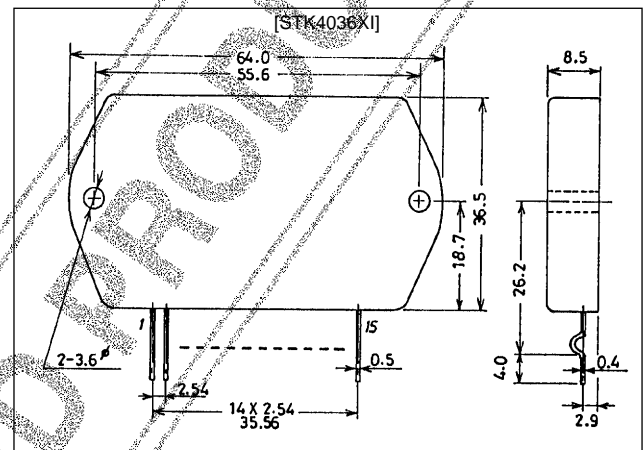

SANYO**STK4036XI****AF Power Amplifier (Split Power Supply)
(50 W min, THD = 0.008%)****Features**

- Compact packaging supports slimmer set designs
- Series designed from 50 up to 150 W and pin-compatibility
- Simpler heat sink design facilitates thermal design of slim stereo sets
- Current mirror circuit, cascade circuit and pure-complimentary circuit application reduce distortion to 0.008 %
- Supports addition of electronic circuits for thermal shutdown and load-short protection circuit as well as pop noise muting which occurs when the power supply switch is turned on and off.

Package Dimensions

unit: mm

4075**Specifications****Maximum Ratings at Ta = 25°C**

Parameter	Symbol	Condition	Rating	Unit
Maximum supply voltage	$V_{CC \max}$		± 53.5	V
Thermal resistance	θ_{j-c}		1.8	°C/W
Junction temperature	T_j		150	°C
Operating substrate temperature	T_c		125	°C
Storage temperature	T_{stg}		-30 to +125	°C
Available time for load shorted	t_s	$V_{CC} = \pm 37 \text{ V}, R_L = 8 \Omega, f = 50 \text{ Hz}, P_O = 50 \text{ W}$	1	s

Recommended Operational Conditions at Ta = 25°C

Parameter	Symbol	Condition	Rating	Unit
Recommended supply voltage	V_{CC}		± 37	V
Load resistance	R_L		8	Ω

STK4036XI

Operating Characteristics

at $T_a = 25^\circ\text{C}$, $V_{CC} = \pm 37\text{ V}$, $R_L = 8\ \Omega$, $V_G = 40\text{ dB}$, $R_g = 600\ \Omega$, 100 k LPF ON, R_L (non-inductive)

Parameter	Symbol	Condition	Rating			Unit
			min	typ	max	
Quiescent current	I_{CCO}	$V_{CC} = \pm 44.5\text{ V}$	15		120	mA
Output power	P_O	THD = 0.008 %, $f = 20\text{ Hz to } 20\text{ kHz}$	50			W
Total harmonic distortion	THD	$P_O = 1.0\text{ W}$, $f = 1\text{ kHz}$			0.008	%
Frequency response	f_L, f_H	$P_O = 1.0\text{ W}$, $+0_{-3}\text{ dB}$		20 to 50k		Hz
Input resistance	r_i	$P_O = 1.0\text{ W}$, $f = 1\text{ kHz}$		55		k Ω
Output noise voltage	V_{NO}^{*2}	$V_{CC} = \pm 44.5\text{ V}$, $R_g = 10\text{ k}\Omega$			1.2	mVrms
Neutral voltage	V_N	$V_{CC} = \pm 44.5\text{ V}$	-70	0	+70	mV

Note: Use rated power supply for test unless otherwise specified.

*1 When measuring permissible load short time and output noise voltage use transformer power supply indicated below.

*2 Output noise voltage represents the peak value on the rms scale (VTVM). The noise voltage waveform does not include the pulse noise.

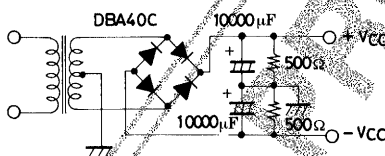

**Specified Transformer Power Supply
(MG-200 Equivalent)**

Equivalent Circuit

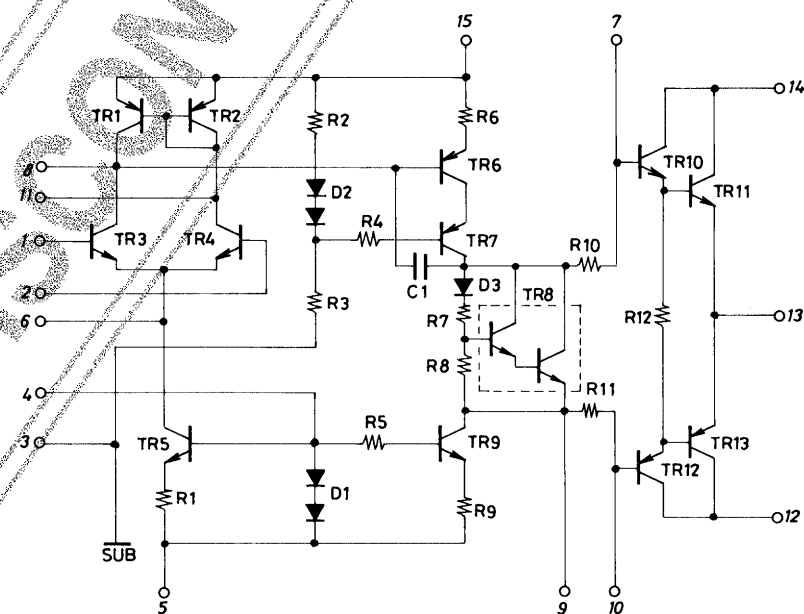

Application Circuit: 50W min Single Channel AF Power Amplifier

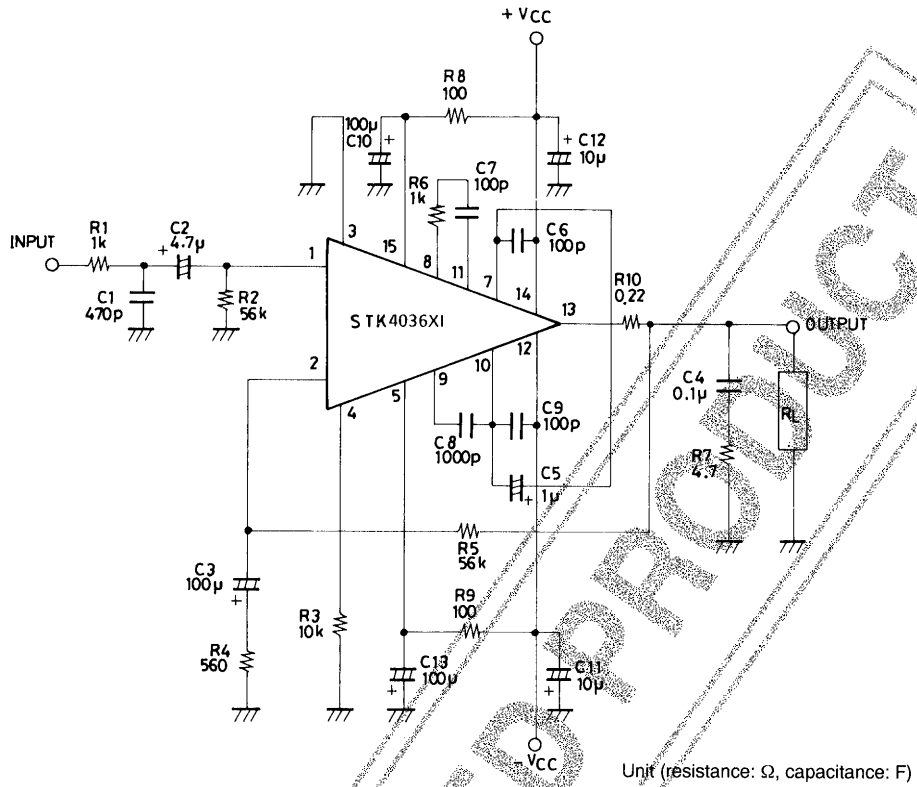

Sample Printed Circuit Pattern for Application Circuit (Copper-foiled side)

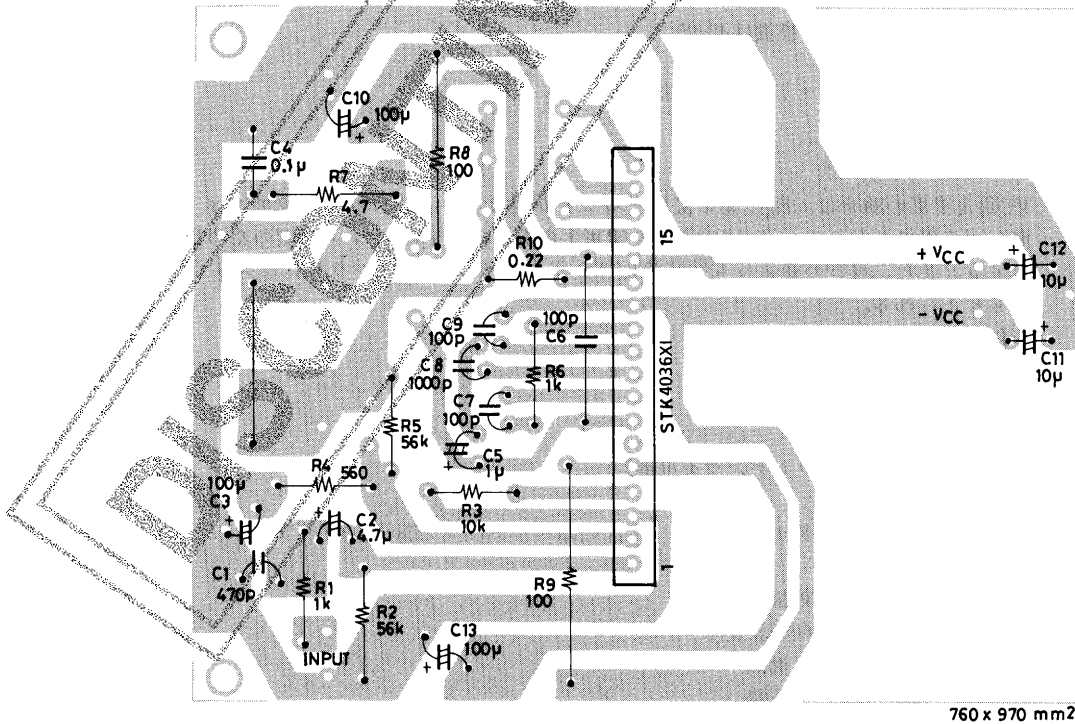

Unit (resistance: Ω, capacitance: F)

Description of External Parts

- R₁, C₁ : Input filter circuit
 - Reduces high-frequency noise.
- C₂ : Input coupling capacitor
 - DC current suppression. A reduction in reactance is effective because of increases in capacitor reactance at low frequencies and 1/f noise dependence on signal source resistance which result in output noise worsening.
- R₂ : Input bias resistor
 - Biases the input pin to zero.
 - Effects V_N stability (refer to NF circuit).
 - Due to differential input, input resistance is more or less determined by this resistance value
- R₄, R₅ : NFB circuit (AC NF circuit). Use of resistor with 1% error is suggested.
- C₃ (R₂)

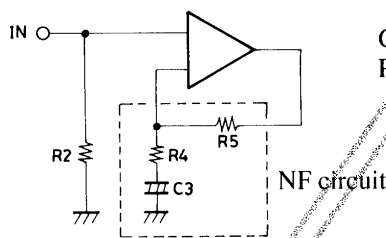

C₃ : AC NF capacitor
 R₄, R₅ : Used for VG setting.

- VG settings are obtained using R₄ and R₅ according to the following equation:

$$\log 20 \cdot \frac{R_5}{R_4} \quad 40 \text{ dB is recommended.}$$

- Low-frequency cutoff frequency settings are obtained using R₄ and C₃ according to the following equation:

$$f_L = \frac{1}{2\pi \cdot R_4 \cdot C_3} \quad [\text{Hz}]$$

When changing the VG setting, you should change R₄ which requires a recheck of the low cutoff frequency setting. When the VG setting is changed using R₅, the setting should ensure R₂ equals R₅ so that V_N balance stability is maintained. If the resistor value is increased more than the existing value, V_N balance may be disturbed and result in deterioration of V_N temperature characteristics.

- R₃ : Differential constant-current bias resistor
- R₆, R₇ : For oscillation suppression and phase compensation applications
(For use with differential stage applications)
- R₇, C₄ : For oscillation suppression and phase compensation applications
(A Mylar capacitor is recommended for C₄ for use with output stage applications)
- C₆, C₉ : For oscillation suppression and phase compensation applications
Power stage (Must be connected near the pin) C₆: Positive (+) power C₉: Negative (-) power
- C₈ : For oscillation suppression and phase compensation applications
(Oscillation suppression before power step clip)
- C₅ : For oscillation suppression and distortion improvement applications
- R₈, C₁₀ : Ripple filter circuit on positive (+) side.
- R₉, C₁₃ : Ripple filter circuit on negative (-) side.
- C₁₁, C₁₂ : For oscillation suppression applications
 - Used for reducing power supply impedance to stable IC operation and should be connected near the IC pin. We recommend that you use an electrolytic capacitor.
- R₁₀ : Output resistor
Increases load shorting endurance capacity during times of high output.

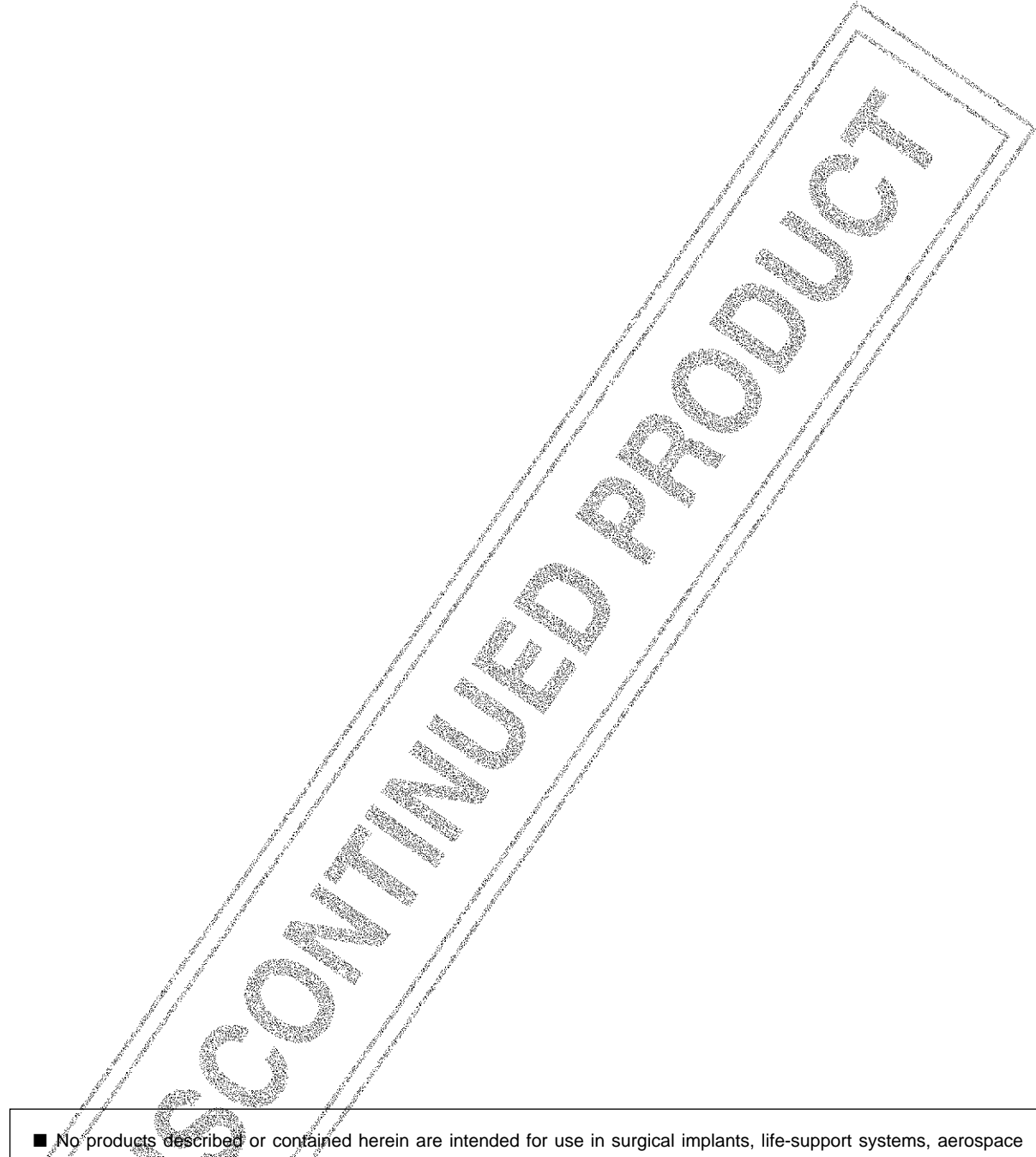
- 
- No products described or contained herein are intended for use in surgical implants, life-support systems, aerospace equipment, nuclear power control systems, vehicles, disaster/crime-prevention equipment and the like, the failure of which may directly or indirectly cause injury, death or property loss.
 - Anyone purchasing any products described or contained herein for an above-mentioned use shall:
 - ① Accept full responsibility and indemnify and defend SANYO ELECTRIC CO., LTD., its affiliates, subsidiaries and distributors and all their officers and employees, jointly and severally, against any and all claims and litigation and all damages, cost and expenses associated with such use:
 - ② Not impose any responsibility for any fault or negligence which may be cited in any such claim or litigation on SANYO ELECTRIC CO., LTD., its affiliates, subsidiaries and distributors or any of their officers and employees jointly or severally.
 - Information (including circuit diagrams and circuit parameters) herein is for example only; it is not guaranteed for volume production. SANYO believes information herein is accurate and reliable, but no guarantees are made or implied regarding its use or any infringements of intellectual property rights or other rights of third parties.

This catalog provides information as of November, 1996. Specifications and information herein are subject to change without notice.