



# LA6358N, 6358NS, 6358NM, 6358NT

## High-Performance Dual Operational Amplifiers

### Overview

The LA6358 is an IC integrating two high-performance operational amplifiers in a single package.

This operational amplifier contains an internal phase compensator and is designed to operate from a single power supply over a wide range of voltages. As with conventional general-purpose operational amplifiers, operation from dual power supplies is also possible and power dissipation is very low. This IC can be used widely in commercial and industrial applications including various transducer amplifiers and DC amplifiers.

### Features

- Eliminates need for phase compensation
- Wide range of operating supply voltage:  
3.0 to 30.0 V (single power supply)  
 $\pm 1.5$  to  $\pm 15.0$  V (dual power supply)
- Input voltage swingable down to nearly ground level and output voltage range  $V_{OUT}$  of 0 to  $V_{CC} - 1.5$  V
- Low current dissipation:  
 $I_{CC} = 0.5$  mA typ/ $V_{CC} = +5$  V,  $R_L = \infty$
- Miniflat package permitting the LA6358NM-applied sets to be made small

### Package Dimensions

unit: mm

#### 3001C

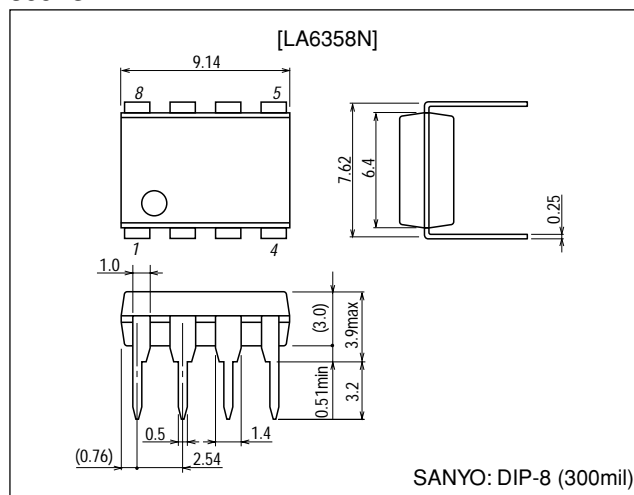

unit: mm

#### 3017D

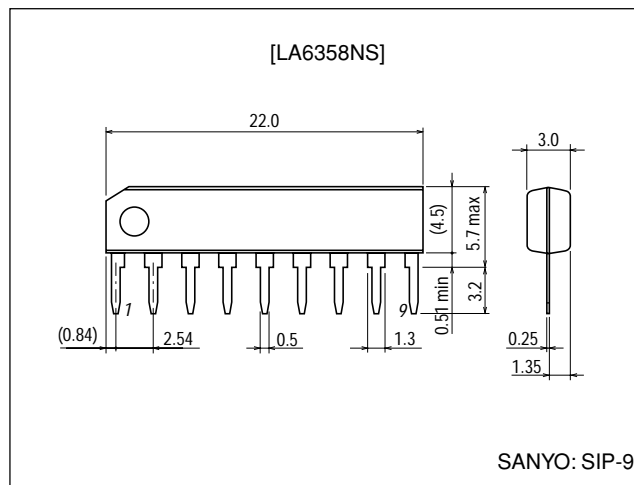

■ Any and all SANYO products described or contained herein do not have specifications that can handle applications that require extremely high levels of reliability, such as life-support systems, aircraft's control systems, or other applications whose failure can be reasonably expected to result in serious physical and/or material damage. Consult with your SANYO representative nearest you before using any SANYO products described or contained herein in such applications.

■ SANYO assumes no responsibility for equipment failures that result from using products at values that exceed, even momentarily, rated values (such as maximum ratings, operating condition ranges, or other parameters) listed in products specifications of any and all SANYO products described or contained herein.

## Package Dimensions

unit: mm

### 3032C

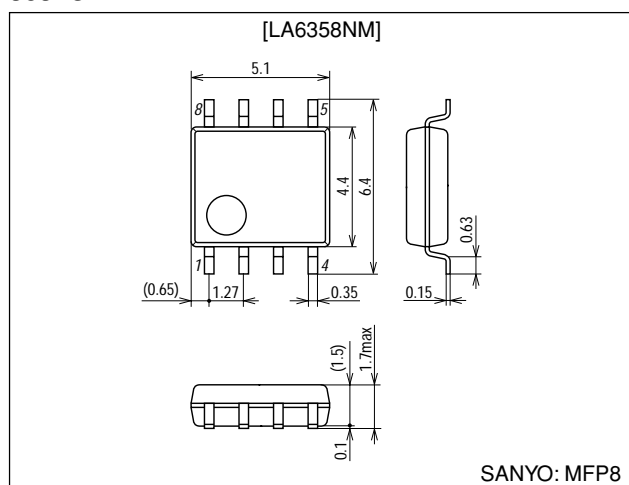

unit: mm

### 3245A

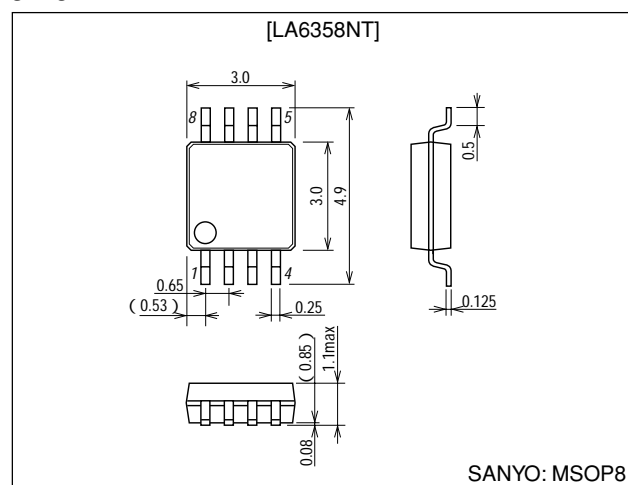

## Specifications

Maximum Ratings at  $T_a = 25^\circ\text{C}$

Parameter	Symbol	Conditions	Ratings	Unit
Maximum Supply Voltage	$V_{CC}$		32	V
Differential Input Voltage	$V_{ID}$		32	V
Maximum Input Voltage	$V_{IN\ max}$		-0.3 to +32	V
Allowable Power Dissipation	$P_d\ max$	$T_a \leq 25^\circ\text{C}$ LA6358N, 6358NS	570	mW
		$T_a \leq 25^\circ\text{C}$ LA6358NM	300	mW
		$T_a \leq 25^\circ\text{C}$ LA6358NT	170	mW
Operating Temperature	$T_{opr}$		-30 to +85	$^\circ\text{C}$
Storage Temperature	$T_{stg}$		-55 to +125	$^\circ\text{C}$

Operating Characteristics at  $T_a = 25^\circ\text{C}$ ,  $V_{CC} = +5\text{ V}$

Parameter	Symbol	Conditions	Test Circuit	Ratings			Unit
				min	typ	max	
Input Offset Voltage	$V_{IO}$		1		$\pm 2$	$\pm 7$	mV
Input Offset Current	$I_{IO}$	$I_{IN(+)} / I_{IN(-)}$	6		$\pm 5$	$\pm 50$	nA
Input Bias Current	$I_B$	$I_{IN(+)} / I_{IN(-)}$	4, 5		45	250	nA
Common-Mode Input Voltage Range	$V_{ICM}$		3	0		$V_{CC} - 1.5$	V
Common-Mode Rejection Ratio	CMRR		3	65	80		dB
Large Signal Voltage Gain	VG	$V_{CC} = 15\text{ V}$ , $R_L \geq 2\text{ k}\Omega$		25	100		V/mV
Output Voltage Range	$V_O$		2	0		$V_{CC} - 1.5$	V
Power Supply Rejection Ratio	SVRR		1	65	100		dB
Channel Separation	CS	$f = 1\text{ k}$ to $20\text{ kHz}$	9		120		dB
Current Dissipation	$I_{CC}$		7		0.5	1.2	mA
Output Current (Source)	$I_{O\ source}$	$V_{IN+} = 1\text{ V}$ , $V_{IN-} = 0\text{ V}$	10	20	40		mA
Output Current (Sink)	$I_{O\ sink}$	$V_{IN+} = 0\text{ V}$ , $V_{IN-} = 1\text{ V}$	11	10	20		mA

### Equivalent Circuit

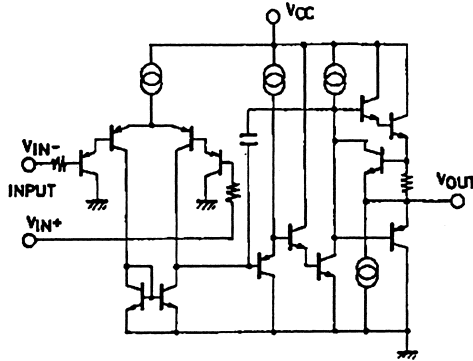

### Pin Assignment

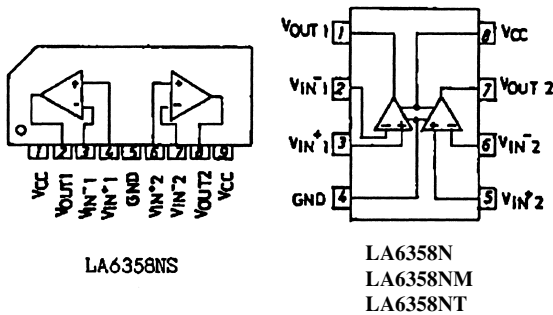

### Test Circuits

#### 1. VIO, SVRR

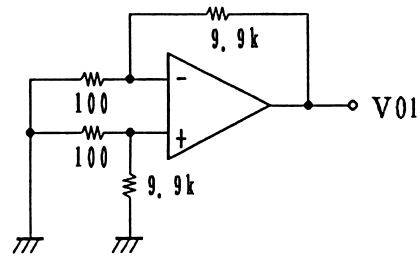

$$V_{IO} = V_{CC}/V_{EE} = \pm 15V$$

$$SVRR \left( \begin{matrix} V_{CC} = 15V, 5V \\ V_{EE} = -5V, -15V \end{matrix} \right)$$

#### 2. VO

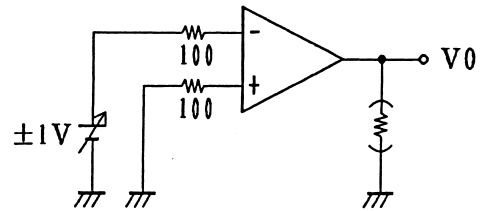

$$V_{IO} = V_{O1}/100$$

$$\frac{SVR(+)}{SVR(-)} = \left| \frac{\Delta V_{O1}}{100 \times 10V} \right|$$

#### 3. CMRR, VICM

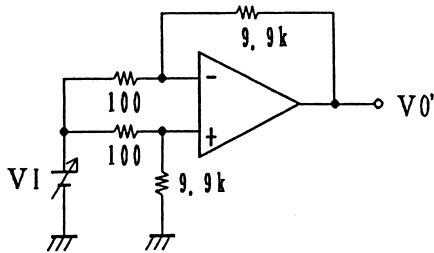

$$CMRR \quad V_I = \pm 7.5V$$

$$CMR = 20 \log \frac{15 \times 100}{|\Delta V_{O'}|}$$

#### 4. IB (+)

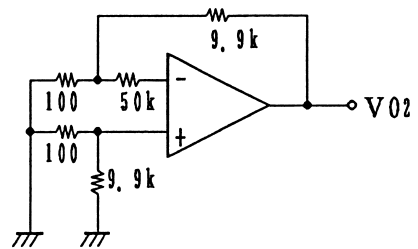

$$I_B(+)= \frac{|V_{O2}-V_{O1}|}{50k \times 100}$$

5. IB (-)

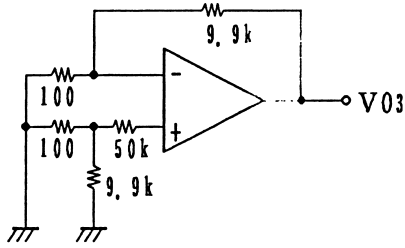

$$I_{B(-)} = \frac{|V_{03} - V_{01}|}{50k \times 100}$$

6. IIO

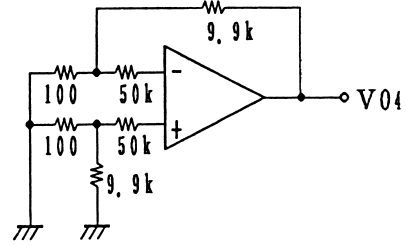

$$I_{IO} = \frac{|V_{04} - V_{01}|}{50k \times 100}$$

7. ICC

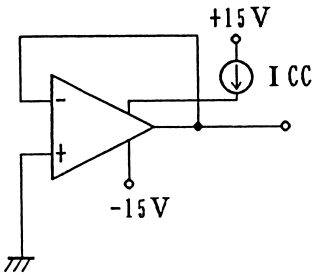

8. SR

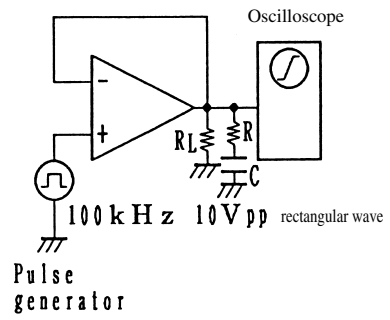

9. Channel Separation CS

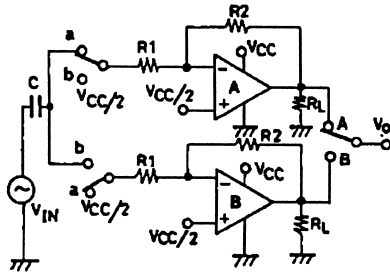

SW : a

$$CS(A \rightarrow B) + 20 \log \frac{R_2 V_{OA}}{R_1 V_{OB}}$$

SW : b

$$CS(B \rightarrow A) + 20 \log \frac{R_2 V_{OB}}{R_1 V_{OA}}$$

10. Output Current IO source

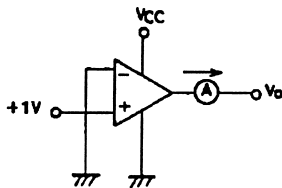

11. Output Current IO sink

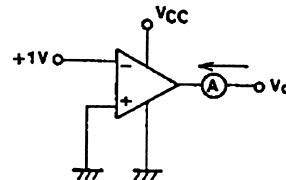

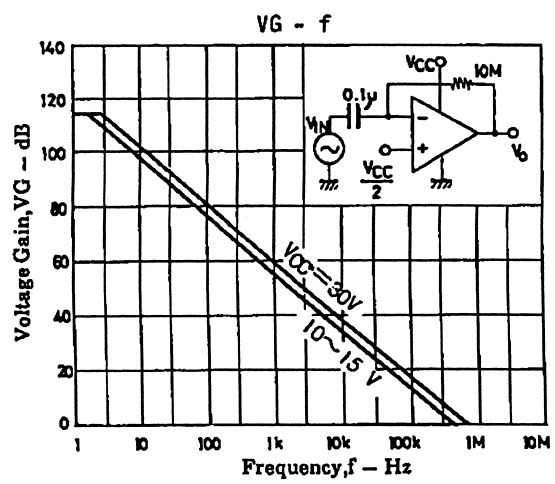
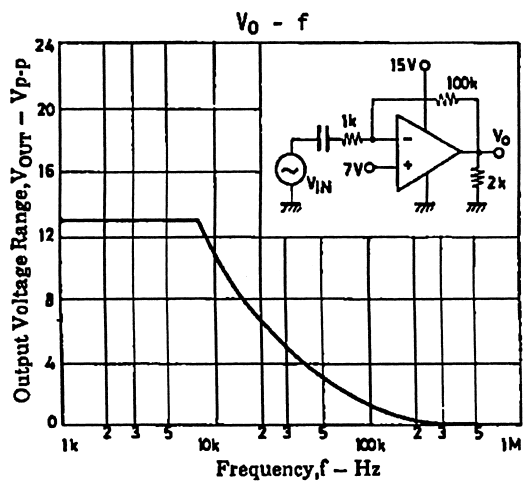
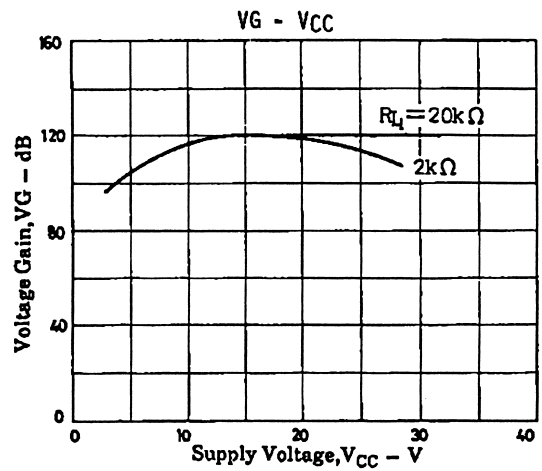
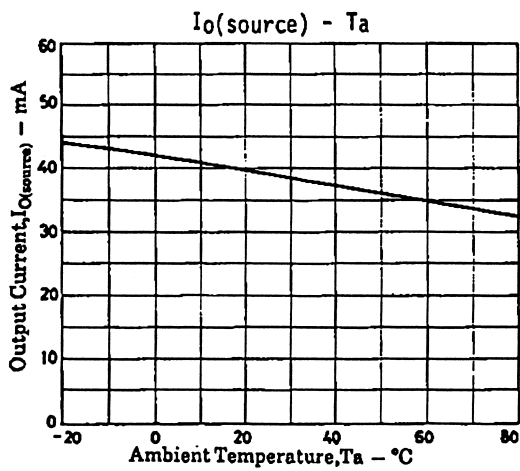
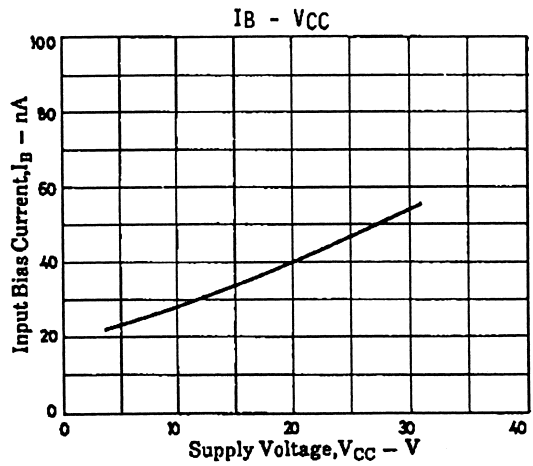
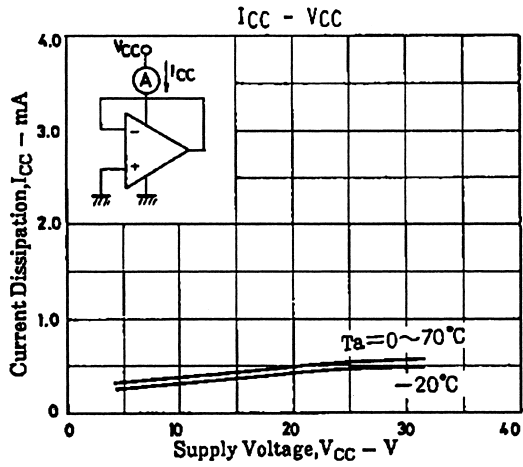

## Sample Application Circuits

Noninverting DC amplifier

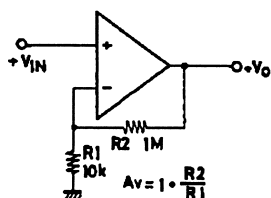

Inverting AC amplifier

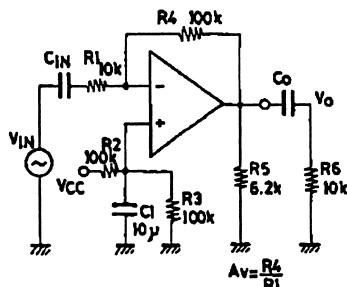

Rectangular wave oscillator

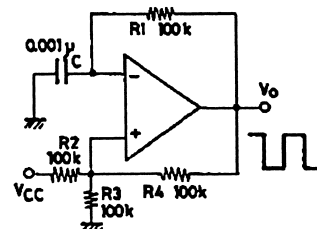

Unit (resistance:  $\Omega$ , capacitance: F)

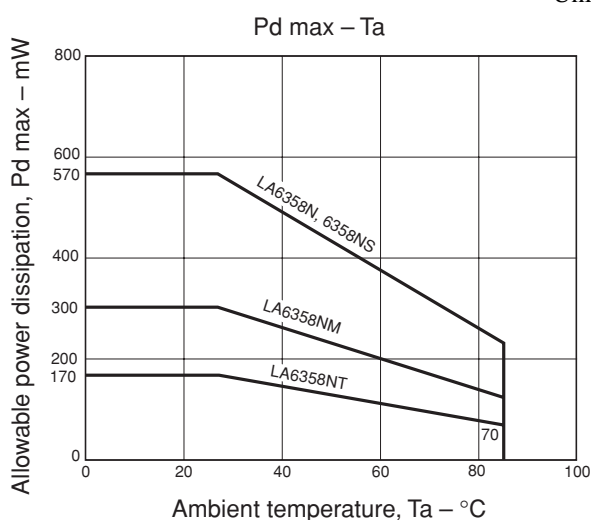

- Specifications of any and all SANYO products described or contained herein stipulate the performance, characteristics, and functions of the described products in the independent state, and are not guarantees of the performance, characteristics, and functions of the described products as mounted in the customer's products or equipment. To verify symptoms and states that cannot be evaluated in an independent device, the customer should always evaluate and test devices mounted in the customer's products or equipment.
- SANYO Electric Co., Ltd. strives to supply high-quality high-reliability products. However, any and all semiconductor products fail with some probability. It is possible that these probabilistic failures could give rise to accidents or events that could endanger human lives, that could give rise to smoke or fire, or that could cause damage to other property. When designing equipment, adopt safety measures so that these kinds of accidents or events cannot occur. Such measures include but are not limited to protective circuits and error prevention circuits for safe design, redundant design, and structural design.
- In the event that any or all SANYO products (including technical data, services) described or contained herein are controlled under any of applicable local export control laws and regulations, such products must not be exported without obtaining the export license from the authorities concerned in accordance with the above law.
- No part of this publication may be reproduced or transmitted in any form or by any means, electronic or mechanical, including photocopying and recording, or any information storage or retrieval system, or otherwise, without the prior written permission of SANYO Electric Co., Ltd.
- Any and all information described or contained herein are subject to change without notice due to product/technology improvement, etc. When designing equipment, refer to the "Delivery Specification" for the SANYO product that you intend to use.
- Information (including circuit diagrams and circuit parameters) herein is for example only; it is not guaranteed for volume production. SANYO believes information herein is accurate and reliable, but no guarantees are made or implied regarding its use or any infringements of intellectual property rights or other rights of third parties.

This catalog provides information as of February, 2003. Specifications and information herein are subject to change without notice.