

SANYO

No. 3353A

LA7956**Video Switch for TV / VCR Use****Features**

- 4 inputs, 1 output, 75Ω termination, driver on-chip
- 6dB amp on-chip
- Excellent crosstalk characteristic
- Wide band

Maximum Ratings at Ta = 25°C

			unit
Maximum Supply Voltage	V7 max	14	V
Maximum Input Supply Voltage (1)	V4 max, V6 max V8 max, V9 max,	8	V
Maximum Input Supply Voltage (2)	V2 max, V3 max	14	V
Maximum Output Current	I1 max	10	mA
Allowable Power Dissipation	Pd max	540	mW
Operating Temperature	Topr	-20 to +65	°C
Storage Temperature	Tstg	-55 to +150	°C

$V_{CC} = 14V$
 $T_a \leq 65^\circ C$

Operating Conditions at Ta = 25°C

			unit
Operating Voltage Range	V _{CC op}	10.5 to 13.5	V
Recommended Supply Voltage	V _{CC}	12	V

Operating Characteristics at Ta = 25°C, V_{CC} = 12V

		min	typ	max	unit
Quiescent Current	I _{CC}	15	21	30	mA
Input Bias Voltage	V4, V6, V8, V9	3.5	3.8	4.1	V
Output Bias Voltage	V1	4.6	6.1	7.6	V
Output DC Offset Voltage	V _{OS} (Note 1)	-50	0	+50	mV
Control Threshold Voltage	V2H, V3H, V2L, V3L	2.3		0.7	V
Control Input Current	I2, I3	-20	-6		μA
Voltage Gain	GV	5.6	6.1	6.4	dB

$f = 1MHz, V_{IN} = 2V_{pp}$ (Note 1)

Continued on next page.

Package Dimensions

(unit : mm)

3017C

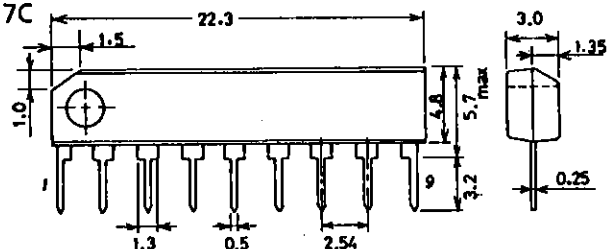

SANYO : SIP9

Continued from preceding page.

			min	typ	max	unit
Frequency Characteristic	GV-f	[0dB at f=100kHz (Note 1) f=10MHz, V _{IN} =1V _{pp}	-3	0		dB
Output Dynamic Range	V _{DR}	f=15kHz, V _{IN} =1.5p-p (Note 1)	1.4	1.5		V _{pp}
Crosstalk (Note 2)	CT	V _{IN} =1V _{p-p} , f=3MHz (Note 1)	50 (48)	58 (55)		dB
		V _{IN} =1V _{p-p} , f=5MHz (Note 1)	45 (45)	55 (52)		dB

※ The current flowing into the IC is defined as positive and current from the IC is defined as negative.

Video Switch Truth Table

S2 (Pin 2)	S3 (Pin 3)	V _{IN} 1 (Pin 4)	V _{IN} 2 (Pin 6)	V _{IN} 3 (Pin 8)	V _{IN} 4 (Pin 9)
H	H	ON	OFF	OFF	OFF
L	H	OFF	ON	OFF	OFF
H	L	OFF	OFF	ON	OFF
L	L	OFF	OFF	OFF	ON

Note 1 : Refer to this Truth Table and make measurements by switching S2, S3.

Note 2 : () : Crosstalk between pins 8 and 9

Input/Output Equivalent Circuit

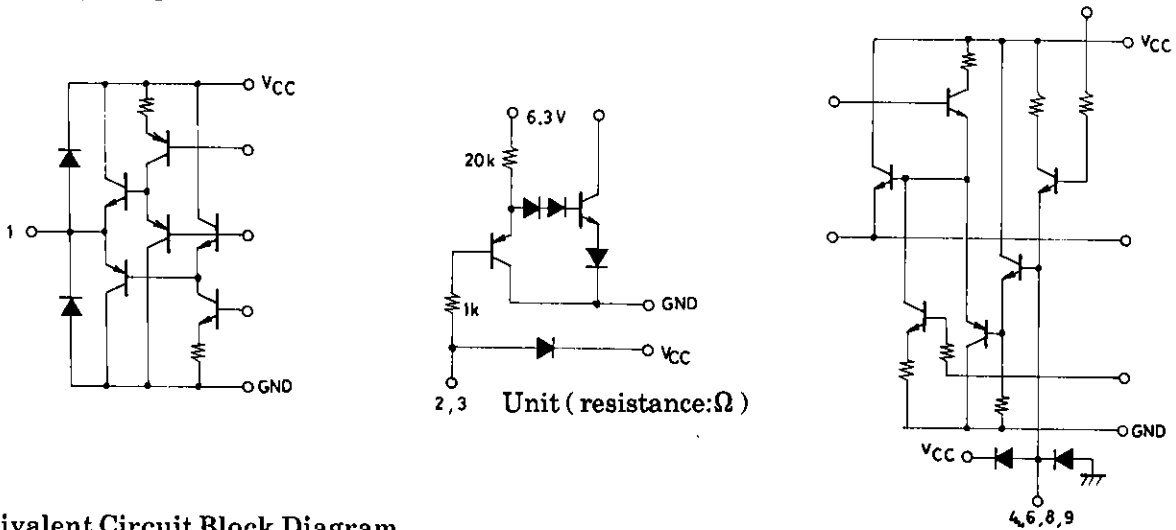

Equivalent Circuit Block Diagram

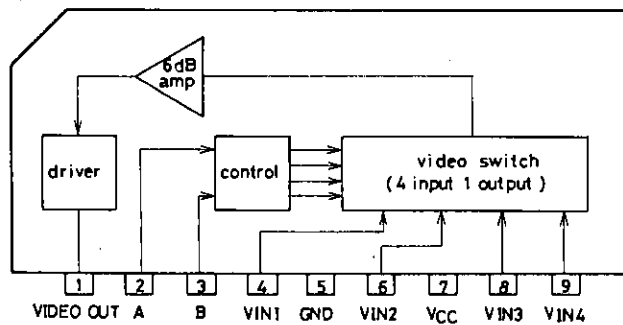

Test Circuit

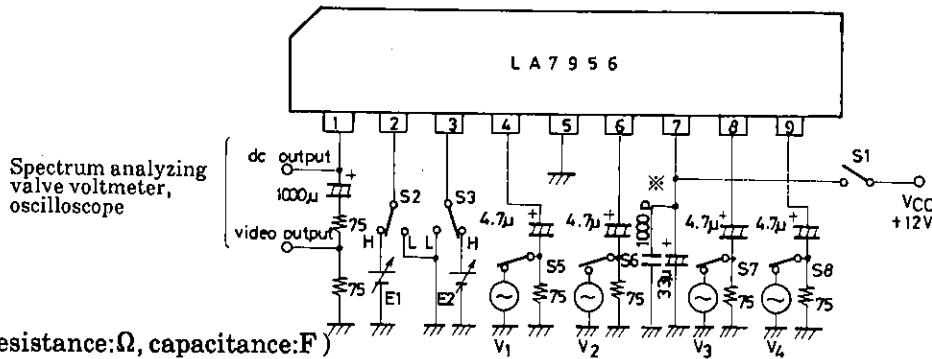

Unit (resistance:Ω, capacitance:F)

※ : Connect the bypass capacitor for V_{CC} as close to pin 7 as possible.

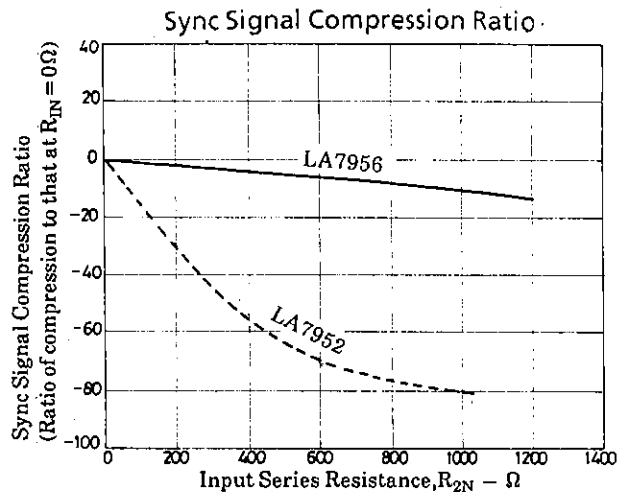
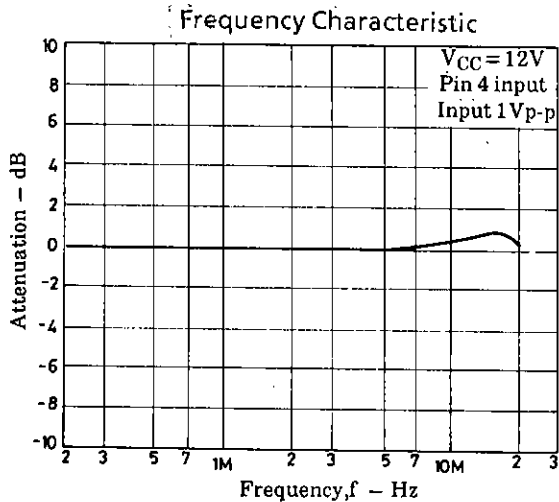
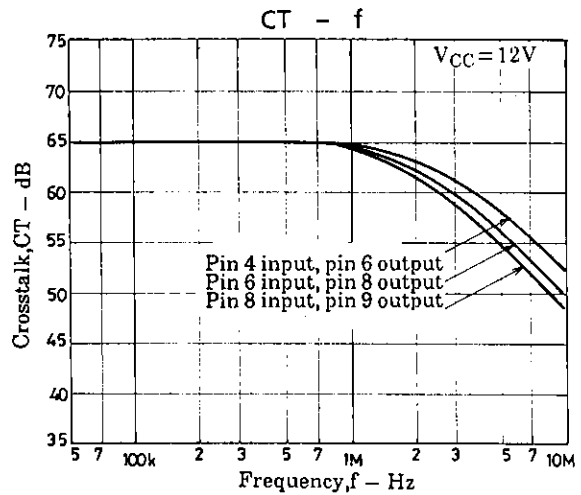
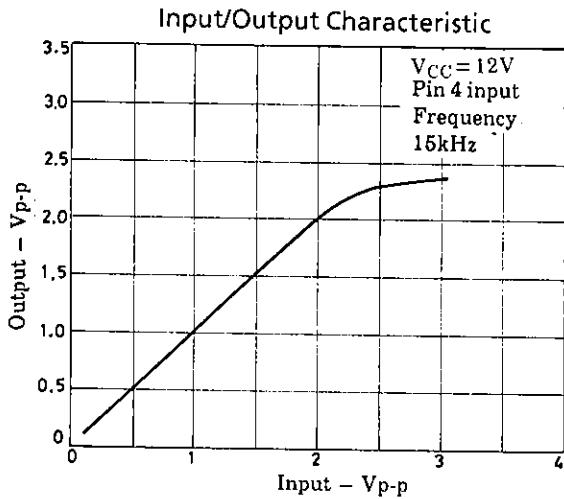

Design Notes

An improvement in the DC clamp circuit has improved the sync signal compression attributable to the signal source impedance, but the response time of the DC clamp is made longer accordingly than that of the LA7952. Make adjustments by connecting a high resistance (several hundred kΩ) across input pin and GND (decreasing the resistance makes the sync signal compression larger).

- No products described or contained herein are intended for use in surgical implants, life-support systems, aerospace equipment, nuclear power control systems, vehicles, disaster/crime-prevention equipment and the like, the failure of which may directly or indirectly cause injury, death or property loss.
- Anyone purchasing any products described or contained herein for an above-mentioned use shall:
 - ① Accept full responsibility and indemnify and defend SANYO ELECTRIC CO., LTD., its affiliates, subsidiaries and distributors and all their officers and employees, jointly and severally, against any and all claims and litigation and all damages, cost and expenses associated with such use:
 - ② Not impose any responsibility for any fault or negligence which may be cited in any such claim or litigation on SANYO ELECTRIC CO., LTD., its affiliates, subsidiaries and distributors or any of their officers and employees jointly or severally.
- Information (including circuit diagrams and circuit parameters) herein is for example only; it is not guaranteed for volume production. SANYO believes information herein is accurate and reliable, but no guarantees are made or implied regarding its use or any infringements of intellectual property rights or other rights of third parties.

This catalog provides information as of **December, 1996**. Specifications and information herein are subject to change without notice.