



ST1802FH

HIGH VOLTAGE FAST-SWITCHING NPN POWER TRANSISTOR

- NEW Fully Plastic TO-220 for HIGH VOLTAGE APPLICATIONS
- NEW SERIES, ENHANCED PERFORMANCE
- EASY MOUNTING
- HIGH VOLTAGE CAPABILITY ($> 1500\text{ V}$)
- HIGH SWITCHING SPEED
- TIGHTER h_{fe} CONTROL
- IMPROVED RUGGEDNESS
- FULLY MOLDED INSULATED PACKAGE (U.L. COMPLIANT) FOR EASY MOUNTING
- CREEPAGE DISTANCE PATH $> 4\text{ mm}$

APPLICATIONS:

- HORIZONTAL DEFLECTION FOR COLOR TVs UP TO 21 INCHES

DESCRIPTION

The device is manufactured using Diffused Collector Technology for more stable operation Vs base drive circuit variations resulting in very low worst case dissipation.

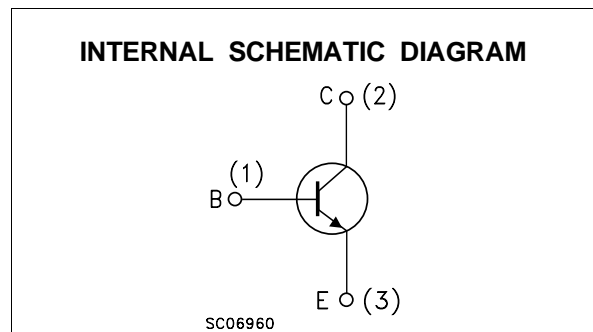
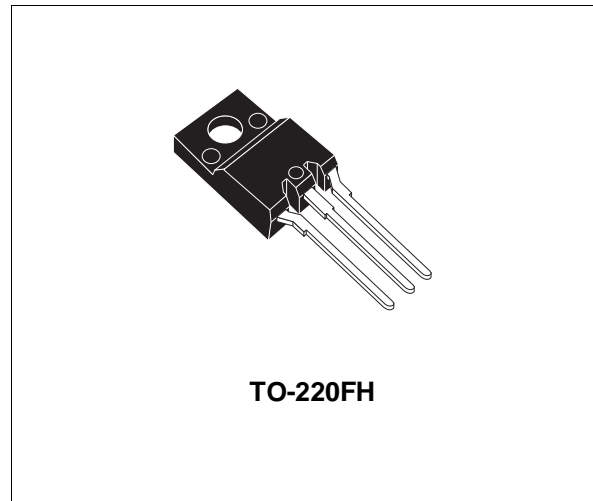

ABSOLUTE MAXIMUM RATINGS

Symbol	Parameter	Value	Unit
V_{CBO}	Collector-Base Voltage ($I_E = 0$)	1500	V
V_{CEO}	Collector-Emitter Voltage ($I_B = 0$)	600	V
V_{EBO}	Emitter-Base Voltage ($I_C = 0$)	7	V
I_C	Collector Current	10	A
I_{CM}	Collector Peak Current ($t_p < 5\text{ ms}$)	15	A
I_B	Base Current	4	A
P_{tot}	Total Dissipation at $T_c = 25\text{ }^\circ\text{C}$	40	W
V_{isol}	Insulation Withstand Voltage (RMS) from All Three Leads to External Heatsink	2500	V
T_{stg}	Storage Temperature	-65 to 150	$^\circ\text{C}$
T_j	Max. Operating Junction Temperature	150	$^\circ\text{C}$

ST1802FH

THERMAL DATA

R _{thj-case}	Thermal Resistance Junction-case	Max	3.125	°C/W
-----------------------	----------------------------------	-----	-------	------

ELECTRICAL CHARACTERISTICS (T_{case} = 25 °C unless otherwise specified)

Symbol	Parameter	Test Conditions	Min.	Typ.	Max.	Unit
I _{CES}	Collector Cut-off Current (V _{BE} = 0)	V _{CE} = 1500 V V _{CE} = 1500 V T _C = 125 °C			1 2	mA mA
I _{EBO}	Emitter Cut-off Current (I _C = 0)	V _{EB} = 7 V			1	mA
V _{CEO(sus)*}	Collector-Emitter Sustaining Voltage (I _B = 0)	I _C = 100 mA L = 25 mH	600			V
V _{CE(sat)*}	Collector-Emitter Saturation Voltage	I _C = 4 A I _B = 0.8 A I _C = 4 A I _B = 1.2 A			5 1.5	V V
V _{BE(sat)*}	Base-Emitter Saturation Voltage	I _C = 4.5 A I _B = 1 A			1.2	V
h _{FE*}	DC Current Gain	I _C = 1 A V _{CE} = 5 V I _C = 5 A V _{CE} = 1 V I _C = 5 A V _{CE} = 5 V	4	25 4.5	9	
t _s t _f	INDUCTIVE LOAD Storage Time Fall Time	I _C = 4 A I _{Bon(END)} = 1 A L _B = 5 μH V _{BB(off)} = -2.5 V f = 16 KHz (see figure 1)		2.6 0.2	4 0.6	μs μs

* Pulsed: Pulse duration = 300 μs, duty cycle 1.5 %

Safe Operating Area

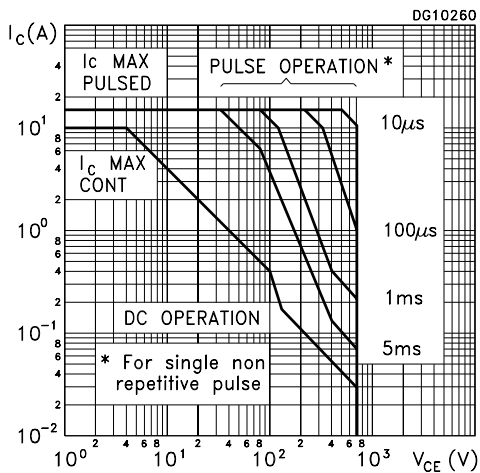

Thermal Impedance

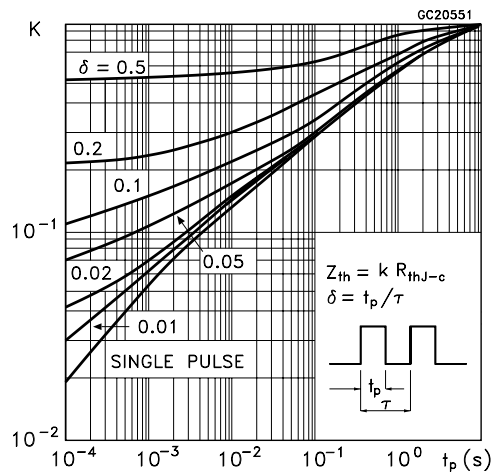

Derating Curve

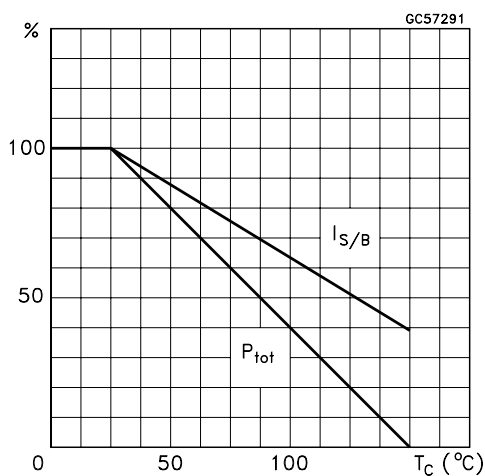

Output Characteristics

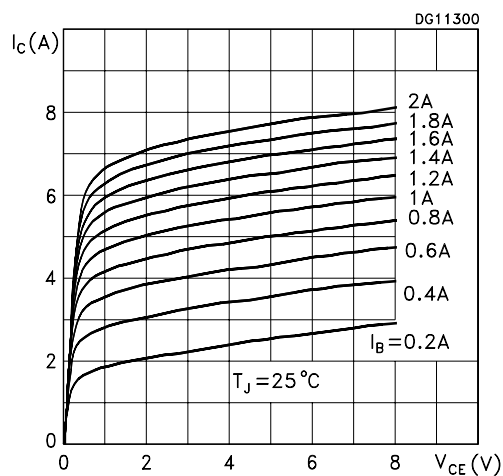

Collector Emitter Saturation Voltage

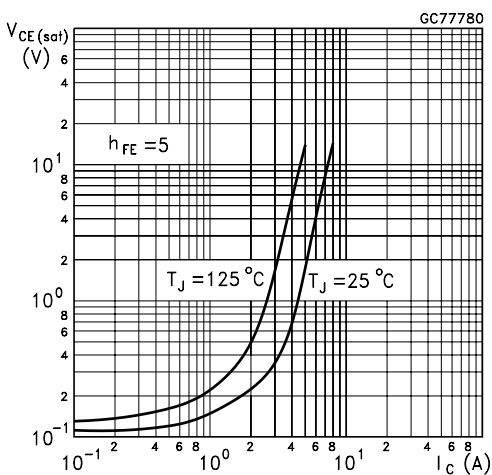

Base Emitter Saturation Voltage

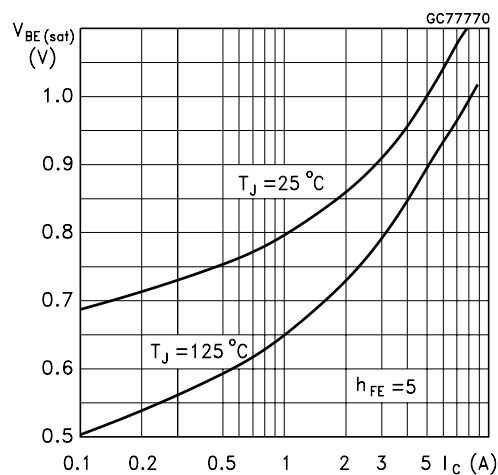

DC Current Gain

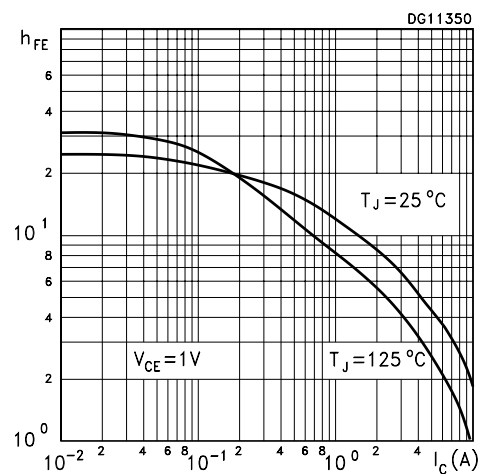

DC Current Gain

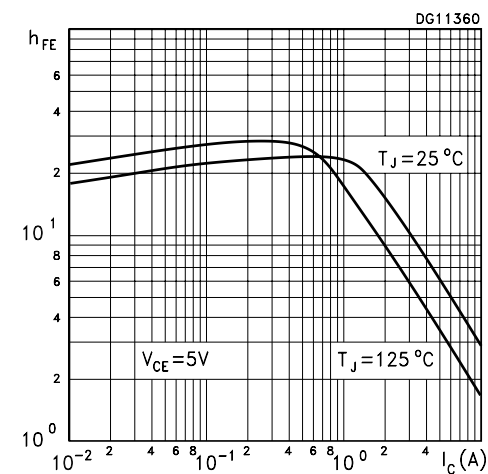

Power Losses At 16 KHz

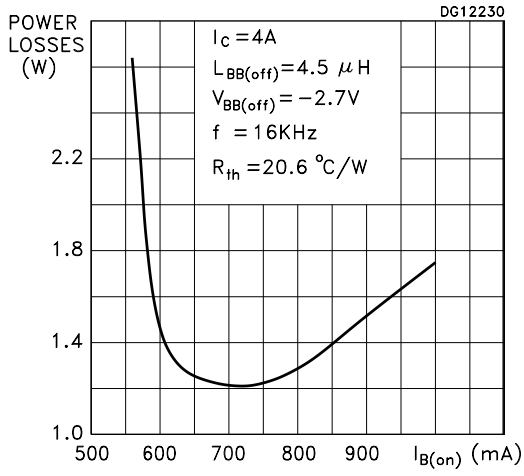

Switching Time Inductive Load

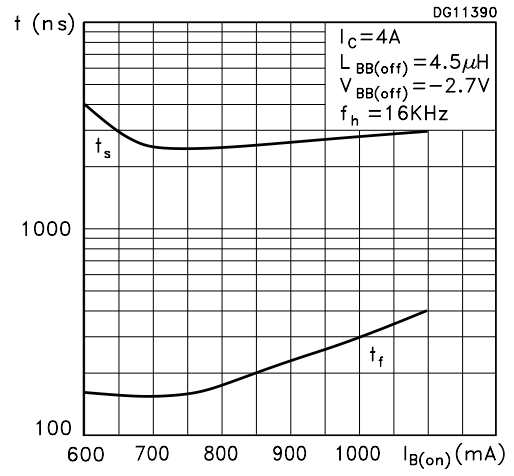

Reverse Biased SOA

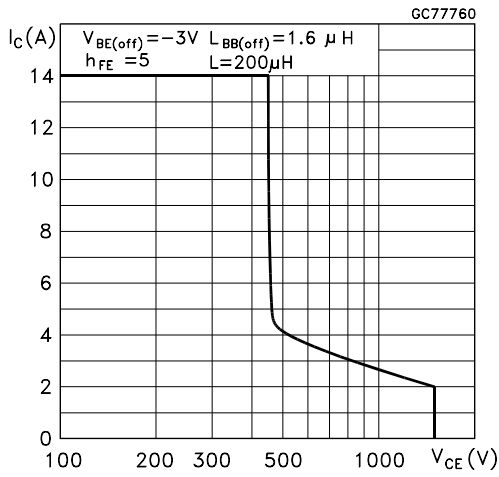
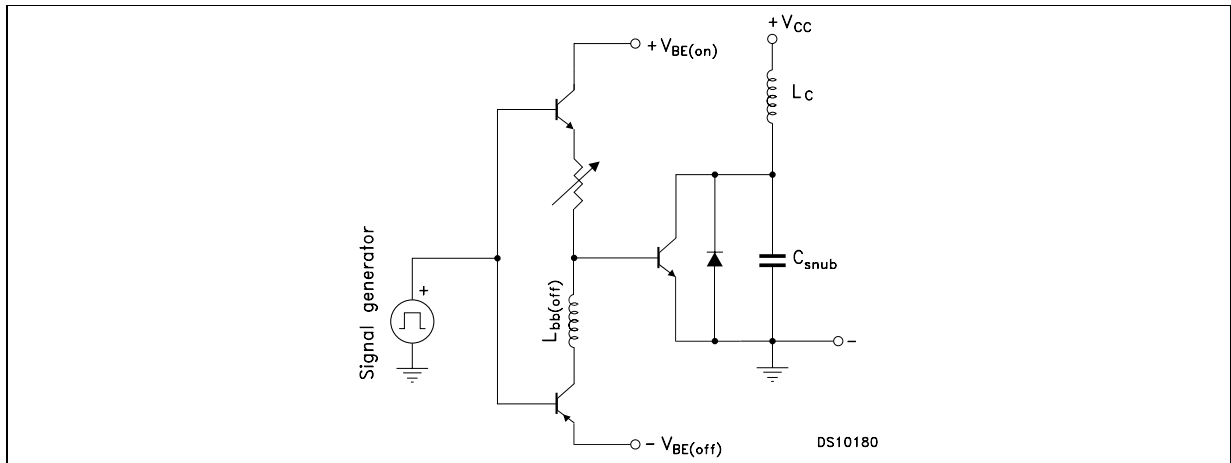
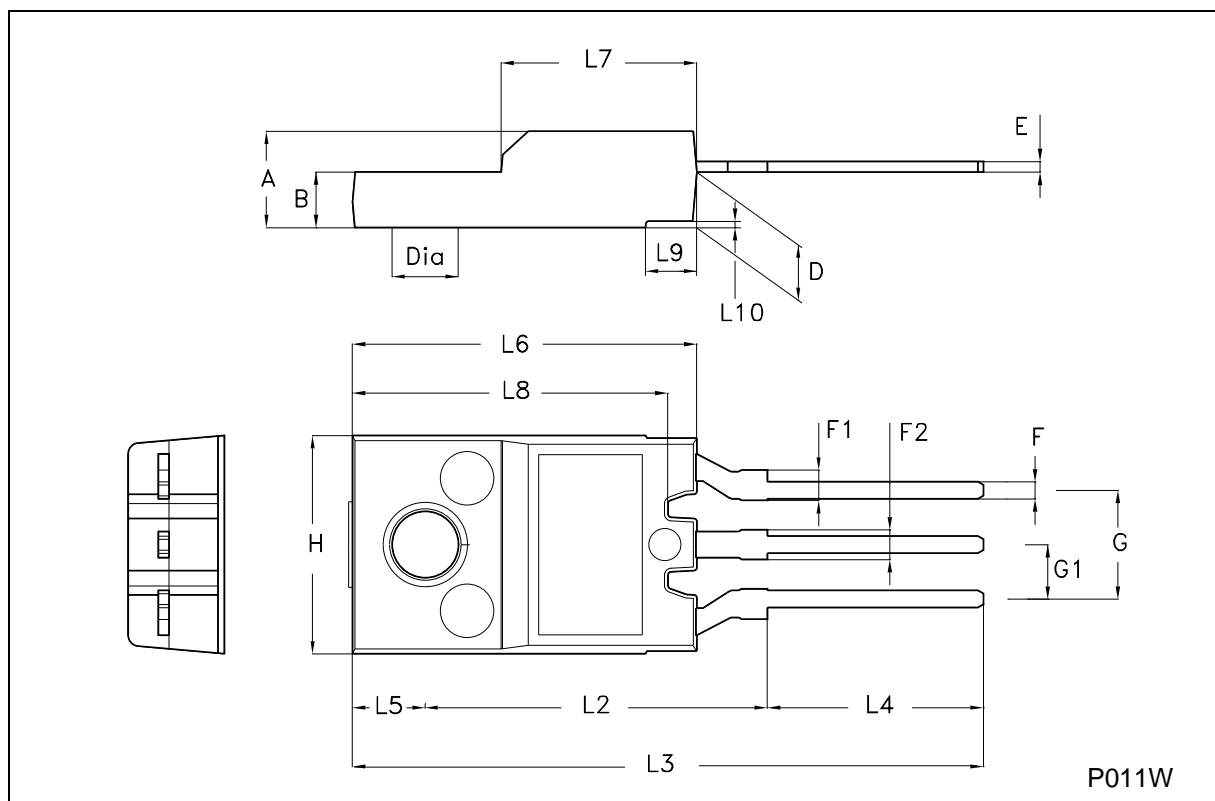

Figure 1: Inductive Load Switching Test Circuit.



TO-220FH (Fully plastic High voltage) MECHANICAL DATA

DIM.	mm			inch		
	MIN.	TYP.	MAX.	MIN.	TYP.	MAX.
A	4.4		4.6	0.173		0.181
B	2.5		2.7	0.098		0.106
D	2.5		2.75	0.098		0.108
E	0.45		0.7	0.017		0.027
F	0.75		1	0.030		0.039
F1	1.3		1.8	0.051		0.070
F2	1.3		1.8	0.051		0.070
G	4.95		5.2	0.195		0.204
G1	2.4		2.7	0.094		0.106
H	10		10.4	0.393		0.409
L2		16			0.630	
L3	28.6		30.6	1.126		1.204
L4	9.8		10.6	0.385		0.417
L5		3.4			0.134	
L6	15.9		16.4	0.626		0.645
L7	9		9.3	0.354		0.366
L8	14.5		15	0.570		0.590
L9		2.4			0.094	



Information furnished is believed to be accurate and reliable. However, STMicroelectronics assumes no responsibility for the consequences of use of such information nor for any infringement of patents or other rights of third parties which may result from its use. No license is granted by implication or otherwise under any patent or patent rights of STMicroelectronics. Specification mentioned in this publication are subject to change without notice. This publication supersedes and replaces all information previously supplied. STMicroelectronics products are not authorized for use as critical components in life support devices or systems without express written approval of STMicroelectronics.

The ST logo is a trademark of STMicroelectronics

© 2002 STMicroelectronics – Printed in Italy – All Rights Reserved

STMicroelectronics GROUP OF COMPANIES

Australia - Brazil - Canada - China - Finland - France - Germany - Hong Kong - India - Israel - Italy - Japan - Malaysia - Malta - Morocco - Singapore - Spain - Sweden - Switzerland - United Kingdom - United States.

<http://www.st.com>

This datasheet has been download from:

www.datasheetcatalog.com

Datasheets for electronics components.