

1400 Bit Serial Electrically Alterable Read Only Memory

FEATURES

- 100 word x 14 bit organization
- Addressing by two consecutive one-of-ten codes
- Single -35 Volt supply
- Word alterable
- 10 year data storage
- MOS compatible signal levels
- Write/erase time: 10ms

DESCRIPTION

The ER1400 is a serial input/output 1400 bit electrically erasable and reprogrammable ROM, organized as 100 words of 14 bits each. Data and address are communicated in serial form via a one-pin bidirectional bus.

Mode selection is by a 3 bit code applied to C1, C2 and C3.

Before writing, a selected location must be preconditioned by an Erase operation. Data is then stored by internal negative writing pulses that selectively tunnel charge into the oxide-nitride interface of the gate insulator of the 1400 MNOS memory transistors. When the writing voltage is removed the charge trapped at the interface is manifested as a negative shift in the threshold voltage of the selected memory transistors.

PIN CONFIGURATIONS

Standard package

14 LEAD DUAL IN LINE

Special Order Package

8 LEAD TO-8 (ER1400T)

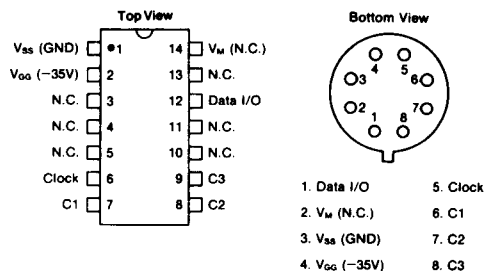

N.C.= No external connection
for normal usage

ELEC. ALTERABLE
NON-VOLATILE MEMORY

BLOCK DIAGRAM

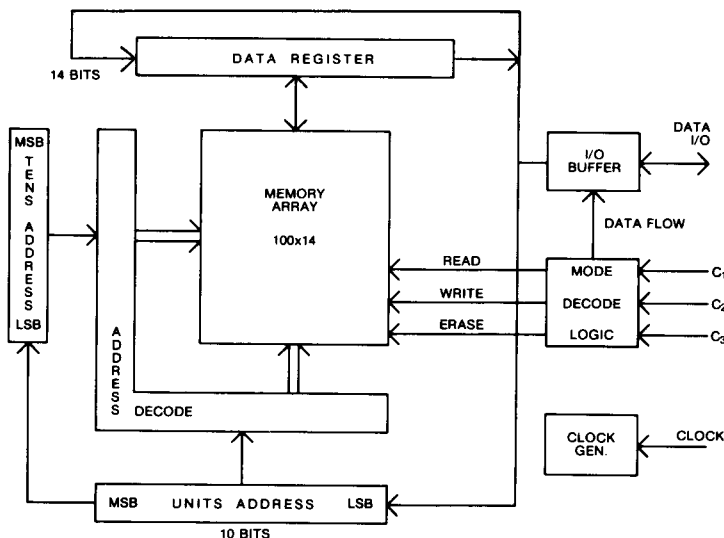

GENERAL INSTRUMENT	ER1400
--------------------	--------

PIN FUNCTIONS

Name	Function																																				
Data	In the Accept Address and Accept Data modes, this pin is an input pin for address and data respectively. When outputting data it has MOS drive capability, while in all other modes it is left floating.																																				
V _M	Used for testing purposes only. Must be left unconnected for normal operation.																																				
V _{SS}	Chip substrate. Normally connected to ground.																																				
V _{GG}	DC supply. Normally connected to V _{SS} -35 Volt supply.																																				
Clock	Timing reference. Required for all operations. May be left at logic zero when device is in standby.																																				
C1,C2,C3	Mode control pins. Their operation is as follows:																																				
	<table border="1"> <thead> <tr> <th>C1</th> <th>C2</th> <th>C3</th> <th>Function</th> </tr> </thead> <tbody> <tr> <td>0</td> <td>0</td> <td>0</td> <td>Standby—the output buffer is left floating. If the clock is maintained, the contents of the Address and Data Registers will remain unchanged.</td> </tr> <tr> <td>0</td> <td>1</td> <td>1</td> <td>Accept Address—Data presented at the I/O pin is shifted into the Address Register with each clock pulse. Addressing is by two consecutive one-of-ten codes.</td> </tr> <tr> <td>1</td> <td>0</td> <td>0</td> <td>Read—The address word is read from memory into the data register.</td> </tr> <tr> <td>1</td> <td>0</td> <td>1</td> <td>Shift Data Out—The output driver is enabled and the contents of the Data Register are shifted out one bit with each clock pulse.</td> </tr> <tr> <td>0</td> <td>1</td> <td>0</td> <td>Erase—The word stored at the addressed location is erased to all ones.</td> </tr> <tr> <td>1</td> <td>1</td> <td>1</td> <td>Accept Data—The data register accepts serial data presented at the I/O pin. The Address Register remains unchanged.</td> </tr> <tr> <td>1</td> <td>1</td> <td>0</td> <td>Write—The word contained in the Data Register is written into the location designated by the Address Register.</td> </tr> <tr> <td>0</td> <td>0</td> <td>1</td> <td>Not Used</td> </tr> </tbody> </table>	C1	C2	C3	Function	0	0	0	Standby—the output buffer is left floating. If the clock is maintained, the contents of the Address and Data Registers will remain unchanged.	0	1	1	Accept Address—Data presented at the I/O pin is shifted into the Address Register with each clock pulse. Addressing is by two consecutive one-of-ten codes.	1	0	0	Read—The address word is read from memory into the data register.	1	0	1	Shift Data Out—The output driver is enabled and the contents of the Data Register are shifted out one bit with each clock pulse.	0	1	0	Erase—The word stored at the addressed location is erased to all ones.	1	1	1	Accept Data—The data register accepts serial data presented at the I/O pin. The Address Register remains unchanged.	1	1	0	Write—The word contained in the Data Register is written into the location designated by the Address Register.	0	0	1	Not Used
C1	C2	C3	Function																																		
0	0	0	Standby—the output buffer is left floating. If the clock is maintained, the contents of the Address and Data Registers will remain unchanged.																																		
0	1	1	Accept Address—Data presented at the I/O pin is shifted into the Address Register with each clock pulse. Addressing is by two consecutive one-of-ten codes.																																		
1	0	0	Read—The address word is read from memory into the data register.																																		
1	0	1	Shift Data Out—The output driver is enabled and the contents of the Data Register are shifted out one bit with each clock pulse.																																		
0	1	0	Erase—The word stored at the addressed location is erased to all ones.																																		
1	1	1	Accept Data—The data register accepts serial data presented at the I/O pin. The Address Register remains unchanged.																																		
1	1	0	Write—The word contained in the Data Register is written into the location designated by the Address Register.																																		
0	0	1	Not Used																																		

ELECTRICAL CHARACTERISTICS

Maximum Ratings*

All inputs and outputs (except V _{GG}) with respect to V _{SS} . . .	-20V to +0.3V
V _{GG} with respect to V _{SS}	-40V
Storage temperature (No Data Retention)	-65° C to +150° C
Storage temperature (with Data Retention)	
Operating	-25° C to +75° C
Unpowered	-65° C to +80° C

* Exceeding these ratings could cause permanent damage to the device. This is a stress rating only and functional operation of this device at these conditions is not implied—operating ranges are specified in Standard Conditions. Exposure to absolute maximum rating conditions for extended periods may affect device reliability.

Data labeled "typical" is presented for design guidance only and is not guaranteed.

Standard Conditions (unless otherwise noted):

V_{SS} = GND

V_{GG} = -35V ±8%

Operating Temperature T_A = 0° C to +70° C

Characteristics	Symbol	Min	Typ**	Max	Units	Conditions
DC CHARACTERISTICS						
Input logic "1"	V _{IL}	V _{SS} -15.0	—	V _{SS} -8.0	Volts	V _{IN} = -15V Load = 1.5 Meg, 100pF I _{SOURCE} = 200μA
Input logic "0"	V _{IH}	V _{SS} -1.0	—	V _{SS} +0.3	Volts	
Input leakage	I _L	—	—	10	μA	
Output logic "1"	V _{OL}	—	—	V _{SS} -12.0	Volts	
Output logic "0"	V _{OH}	V _{SS} -1.0	—	V _{SS} +0.3	Volts	
Power consumption	P _{GG}	—	—	300	mW	
Power supply current	I _{GG}	—	—	8.0	mA	
AC CHARACTERISTICS						
Clock Frequency	f _φ	10.0	14.0	17.0	kHz	Load - 1 Meg, 100pF See Note 1. Per word. See Note 2. Per word
Clock duty cycle	D _φ	35	50	65	%	
Write time	t _w	10.0	15.0	24.0	ms	
Erase time	t _e	10.0	15.0	24.0	ms	
Rise, fall time	t _r , t _f	—	—	1.0	μs	
Control, Data set up time	t _{CS}	1	—	—	μs	
Control, Data hold time	t _{CH}	0	—	—	μs	
Propagation delay	t _{pw}	—	—	20.0	μs	
Non-volatile data storage	T _S	10	—	—	Years	
Number of erase/write cycles	N _w	—	—	10 ⁴	—	
Number of read accesses between writes	N _{RA}	10 ⁹	—	—	—	

** Typical values are at +25° C and nominal voltages.

NOTE 1: T_S is for powered or unpowered storage.

NOTE 2: N_w (=10⁴) is a maximum for data retention times greater than 10 years. Beyond 10⁴ reprogramming cycles, there is a gradual, logarithmic reduction in retention time with 1 year being a typical value after 10⁵ cycles.

TIMING DIAGRAMS

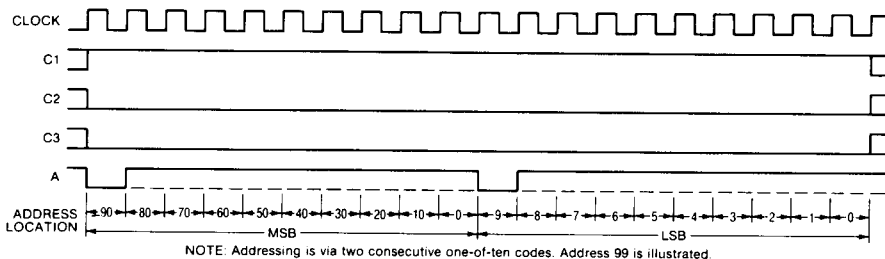

Fig.1 ACCEPT ADDRESS

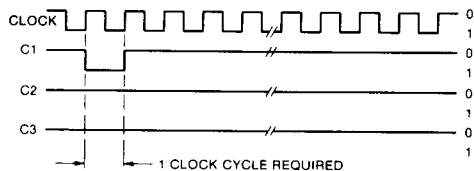
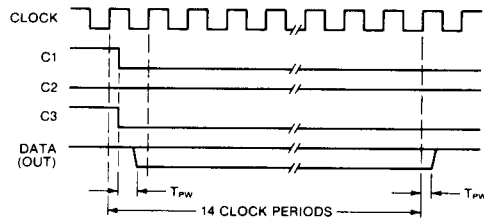

Fig.2 READ



T_{pw} measured initially from control line transition to data out, then measured from the positive clock edges to data changes. Timing measurements are made at $V_{ss} - 2$ and -10 volt points.

Fig.3 SHIFT DATA OUT

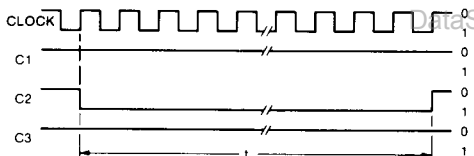

Fig.4 ERASE

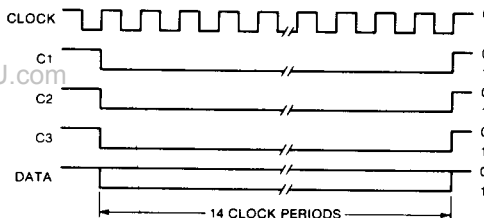

Fig.5 ACCEPT DATA

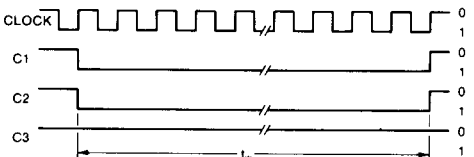

Fig.6 WRITE

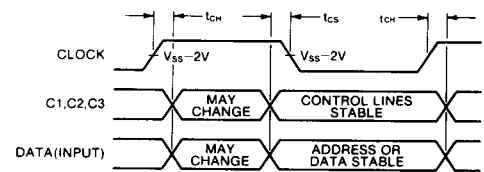

Fig.7 INPUT TIMING

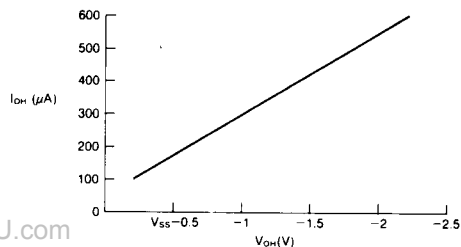

Fig.8 TYPICAL OUTPUT SOURCE CURRENT vs OUTPUT VOLTAGE

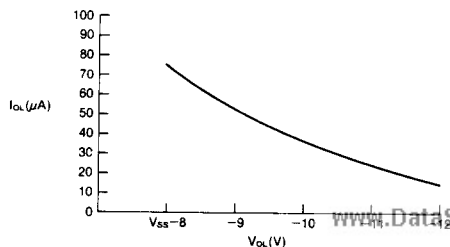

Fig.9 TYPICAL OUTPUT SINK CURRENT vs OUTPUT VOLTAGE

ELEC. ALTERABLE
NON-VOLATILE MEMORY