

KA5H0380R/KA5M0380R/KA5L0380R

SPS

Features

- Precision fixed operating frequency (100/67/50kHz)
- Low start-up current (typ. 100uA)
- Pulse by pulse current limiting
- Over current protection
- Over voltage protection (Min. 25V)
- Internal thermal shutdown function
- Under voltage lockout
- Internal high voltage sense FET
- Auto-restart mode

Description

The SPS product family is specially designed for an off-line SMPS with minimal external components. The SPS consist of high voltage power SenseFET and current mode PWM IC. Included PWM controller features integrated fixed frequency oscillator, under voltage lock-out, leading edge blanking, optimized gate turn-on/turn-off driver, thermal shutdown protection, over voltage protection, and temperature compensated precision current sources for loopcompensation and fault protection circuitry. Compared to discrete MOSFET and PWM controller or RCC solution, a SPS can reduce total component count, design size, weight and at the same time increase efficiency, productivity, and system reliability. It has a basic platform well suited for cost-effective design in either a flyback converter or a forward converter.

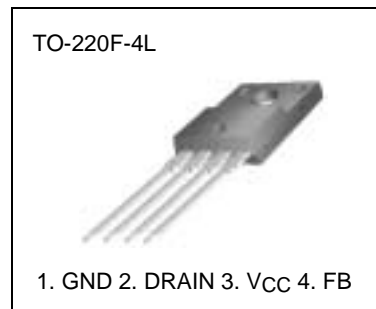

Internal Block Diagram

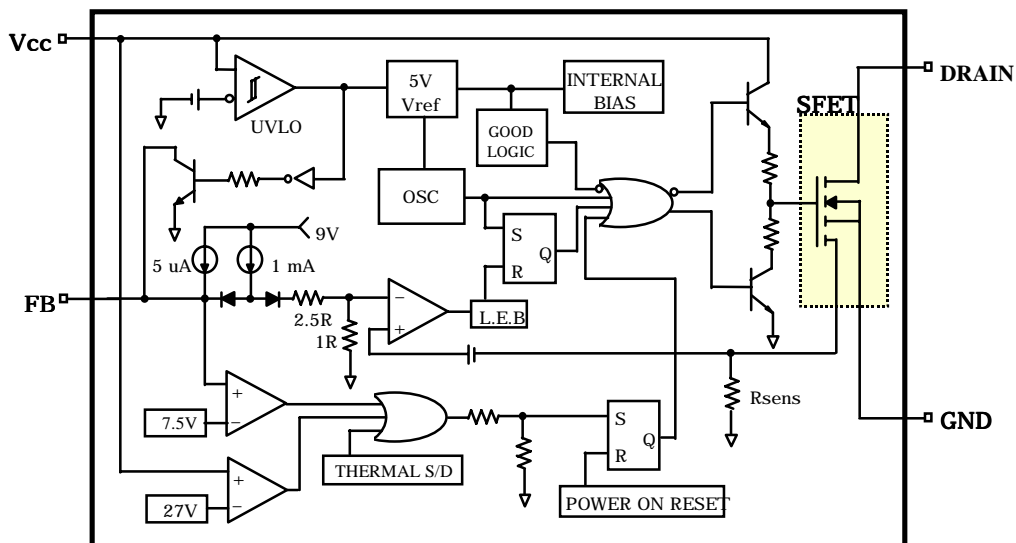

Absolute Maximum Ratings

Characteristic	Symbol	Value	Unit
Drain-source (GND) voltage ⁽¹⁾	VDSS	800	V
Drain-Gate voltage (RGS=1MΩ)	VDGR	800	V
Gate-source (GND) voltage	VGS	±30	V
Drain current pulsed ⁽²⁾	IDM	12	ADC
Single pulsed avalanche energy ⁽³⁾	EAS	95	mJ
Avalanche current ⁽⁴⁾	IAS	10	A
Continuous drain current (TC=25°C)	ID	3.0	ADC
Continuous drain current (TC=100°C)	ID	2.1	ADC
Supply voltage	VCC	30	V
Analog input voltage range	VFB	-0.3 to VSD	V
Total power dissipation	PD (watt H/S)	35	W
	Derating	0.28	W/°C
Operating temperature	TOPR	-25 to +85	°C
Storage temperature	TSTG	-55 to +150	°C

Notes:

1. Tj=25°C to 150°C
2. Repetitive rating: Pulse width limited by maximum junction temperature
3. L=51mH, starting Tj=25°C
4. L=13μH, starting Tj=25°C

Electrical Characteristics (SFET part)

(Ta = 25°C unless otherwise specified)

Characteristic	Symbol	Test condition	Min.	Typ.	Max.	Unit
Drain-source breakdown voltage	BVDSS	VGS=0V, ID=50μA	800	–	–	V
Zero gate voltage drain current	IDSS	VDS=Max., Rating, VGS=0V	–	–	250	μA
		VDS=0.8Max., Rating, VGS=0V, TC=125°C	–	–	1000	μA
Static drain-source on resistance ^(note)	RDS(ON)	VGS=10V, ID=0.5A	–	4	5	Ω
Forward transconductance ^(note)	gfs	VDS=50V, ID=0.5A	1.5	2.5	–	S
Input capacitance	Ciss	VGS=0V, VDS=25V, f=1MHz	–	779	–	pF
Output capacitance	Coss		–	75.6	–	
Reverse transfer capacitance	Crss		–	24.9	–	
Turn on delay time	td(on)	VDD=0.5BVDSS, ID=1.0A (MOSFET switching time are essentially independent of operating temperature)	–	40	–	nS
Rise time	tr		–	95	–	
Turn off delay time	td(off)		–	150	–	
Fall time	tf		–	60	–	
Total gate charge (gate-source+gate-drain)	Qg	VGS=10V, ID=1.0A, VDS=0.5BVDSS (MOSFET switching time are essentially independent of operating temperature)	–	–	34	nC
Gate-source charge	Qgs		–	7.2	–	
Gate-drain (Miller) charge	Qgd		–	12.1	–	

Note:

Pulse test: Pulse width ≤ 300μS, duty ≤ 2%

$$S = \frac{1}{R}$$

Electrical Characteristics (SFET part) (Continued)

(Ta = 25°C unless otherwise specified)

Characteristic	Symbol	Test condition	Min.	Typ.	Max.	Unit
REFERENCE SECTION						
Output voltage ⁽¹⁾	Vref	Ta=25°C	4.80	5.00	5.20	V
Temperature Stability ⁽¹⁾⁽²⁾	Vref/ΔT	-25°C≤Ta≤+85°C	-	0.3	0.6	mV/°C
OSCILLATOR SECTION						
Initial accuracy	FOSC	KA5H0380R	90	100	110	kHz
Initial accuracy	FOSC	KA5M0380R	61	67	73	kHz
Initial accuracy	FOSC	KA5L0380R	45	50	55	kHz
Frequency change with temperature ⁽²⁾		-25°C≤Ta≤+85°C	-	±5	±10	%
PWM SECTION						
Maximum duty cycle	Dmax	KA5H0380R	62	67	72	%
Maximum duty cycle	Dmax	KA5M0380R KA5L0380R	72	77	82	%
FEEDBACK SECTION						
Feedback source current	IFB	Ta=25°C, 0V≤Vfb≤3V	0.7	0.9	1.1	mA
Shutdown delay current	Idelay	Ta=25°C, 5V≤Vfb≤VSD	4	5	6	μA
OVER CURRENT PROTECTION SECTION						
Over current protection	IL(max)	Max. inductor current	1.89	2.15	2.41	A
UVLO SECTION						
Start threshold voltage	Vth(H)	-	8.4	9	9.6	V
Minimum operating voltage	Vth(L)	After turn on	14	15	16	V
TOTAL STANDBY CURRENT SECTION						
Start current	IST	VCC=14V	-	0.1	0.17	mA
Operating supply current (control part only)	IOPR	VCC≤28	-	7	12	mA
SHUTDOWN SECTION						
Shutdown Feedback voltage	VSD	Vfb≥6.5V	6.9	7.5	8.1	V
Thermal shutdown temperature (Tj) ⁽¹⁾	TSD	-	140	160	-	°C
Over voltage protection	VOVP	VCC≥24V	25	27	29	V

NOTE:

1. These parameters, although guaranteed, are not 100% tested in production
2. These parameters, although guaranteed, are tested in EDS(water test) process

Typical Performance Characteristics

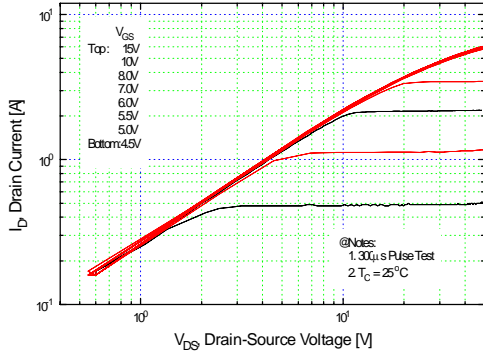

Figure 1. Output Characteristics

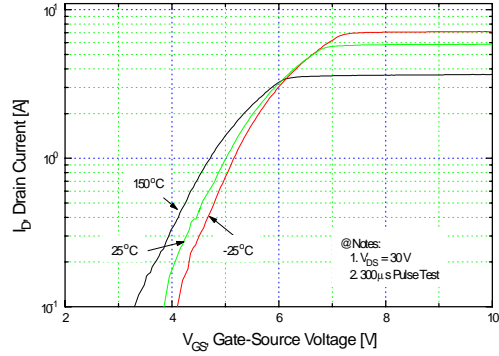

Figure 2. Transfer Characteristics

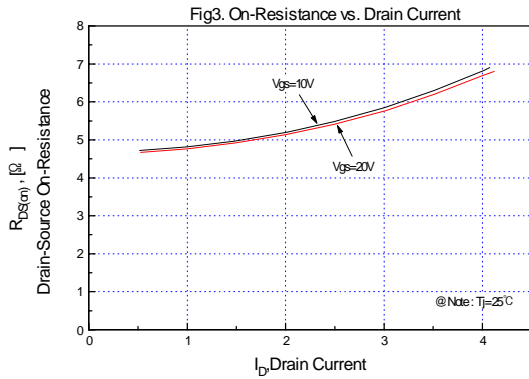

Figure 3. On-Resistance vs. Drain Current

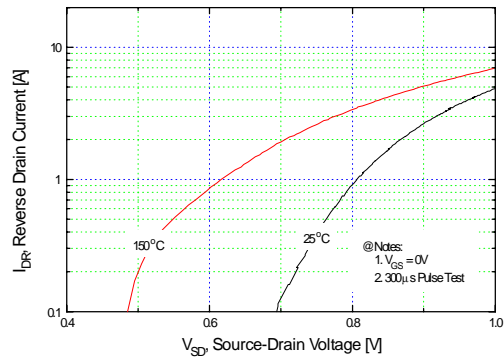

Figure 4. Source-Drain Diode Forward Voltage

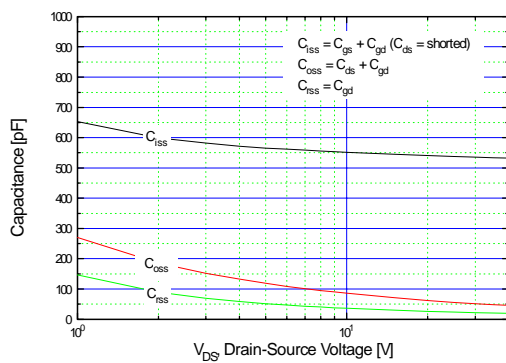

Figure 5. Capacitance vs. Drain-Source Voltage

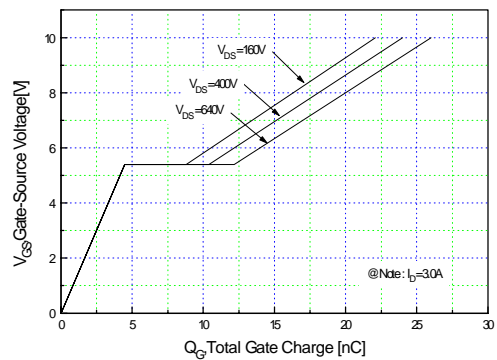

Figure 6. Gate Charge vs. Gate-Source Voltage

typical performance characteristics (continued)

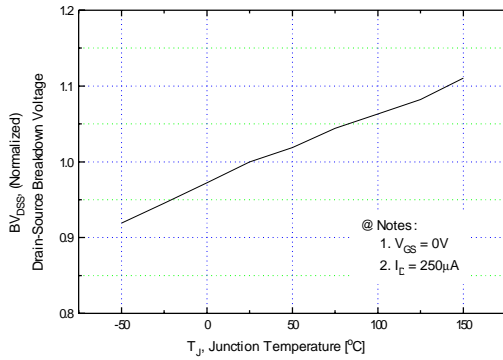

Figure 7. Breakdown Voltage vs. Temperature

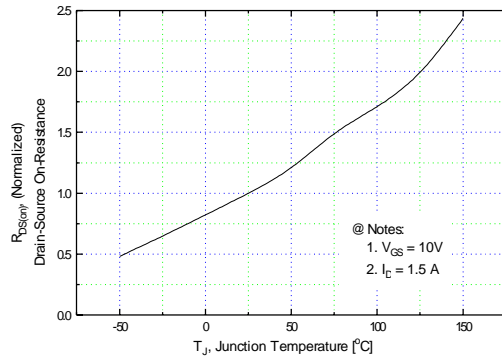

Figure 8. On-Resistance vs. Temperature

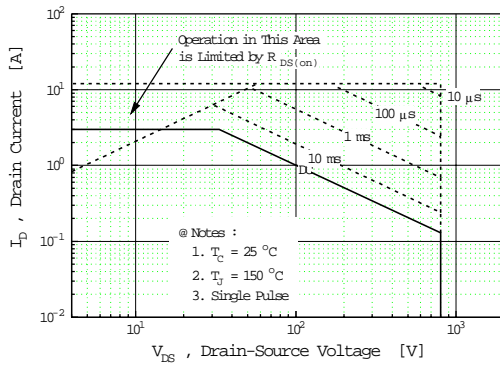

Figure 9. Max. Safe Operating Area

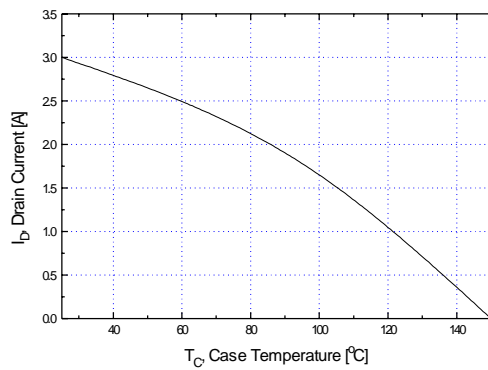

Figure 10. Max. Drain Current vs. Case Temperature

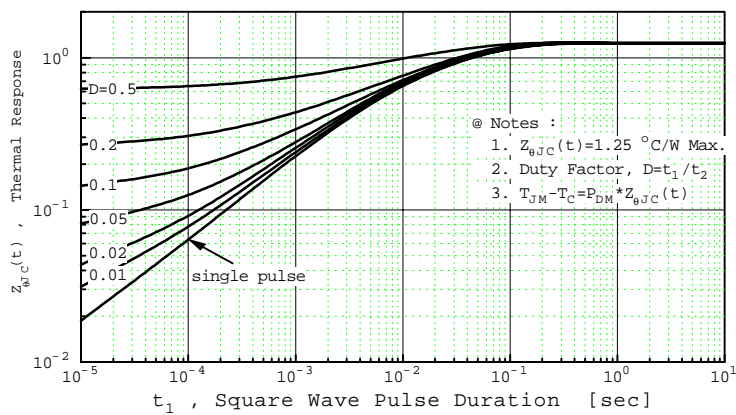

Figure 11. Thermal Response

typical performance characteristics (control part)

(These characteristic graphs are normalized at $T_a = 25^\circ\text{C}$)

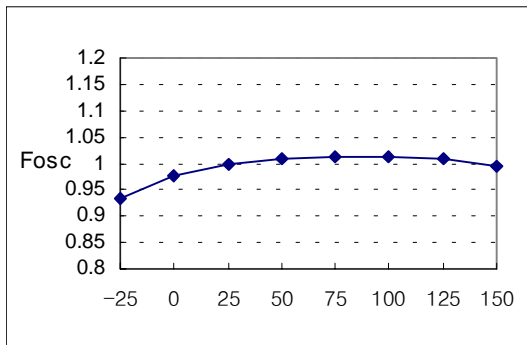

Figure 1. Operating Frequency

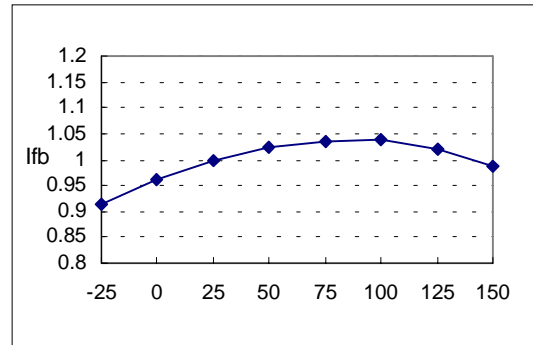

Figure 2. Feedback Source Current

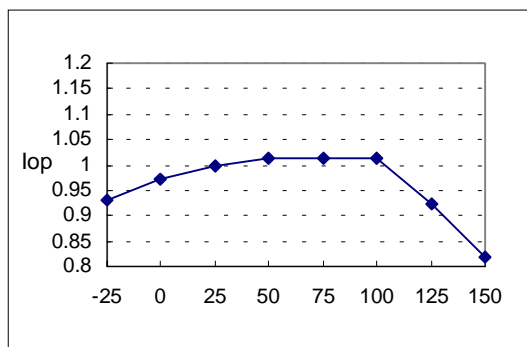

Figure 3. Operating Current

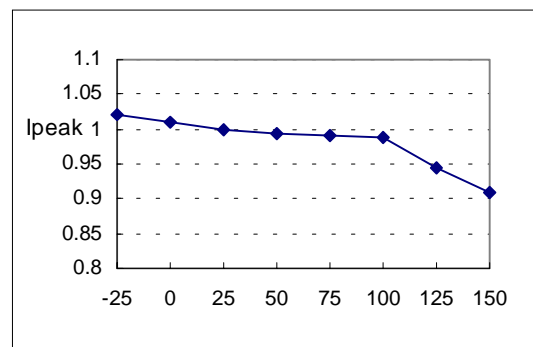

Figure 4. Max Inductor Current

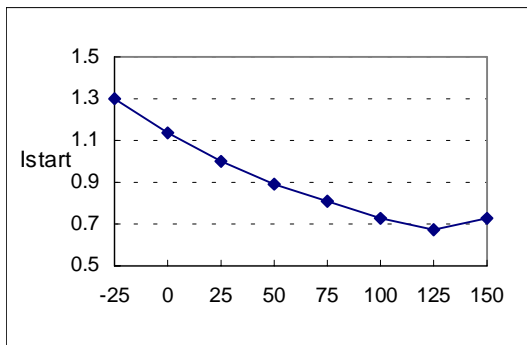

Figure 5. Start up Current

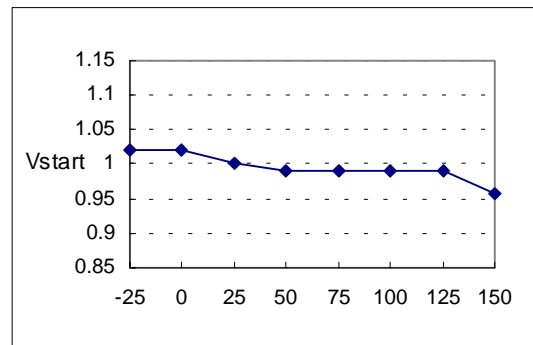

Figure 6. Start Threshold Voltage

typical performance characteristics (continued)

(These characteristic graphs are normalized at $T_a = 25^\circ\text{C}$)

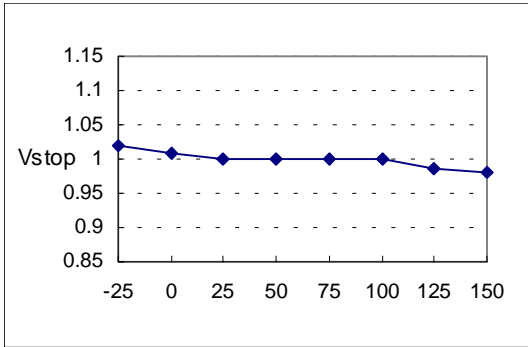

Figure 7. Stop Threshold Voltage

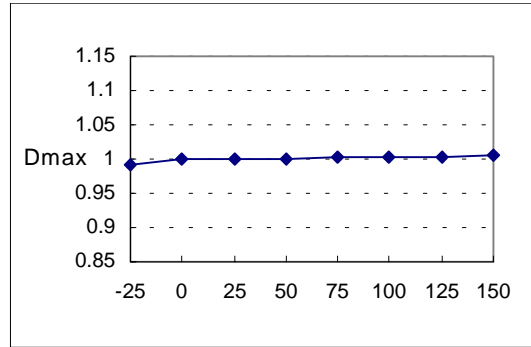

Figure 8. Maximum Duty Cycle

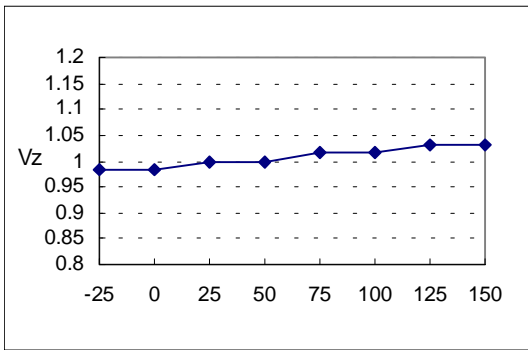

Figure 9. VCC Zener Voltage

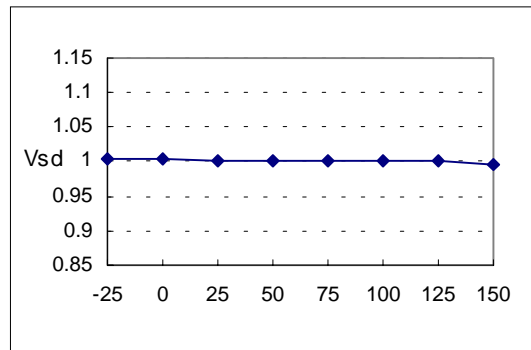

Figure 10. Shutdown Feedback Voltage

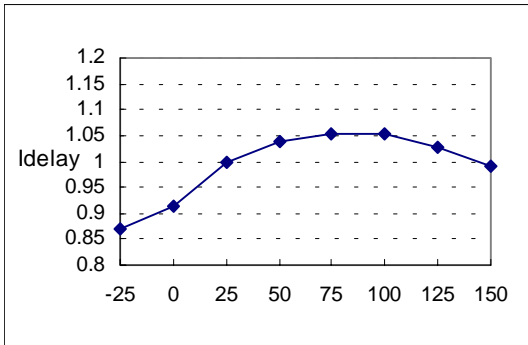

Figure 11. Shutdown Delay Current

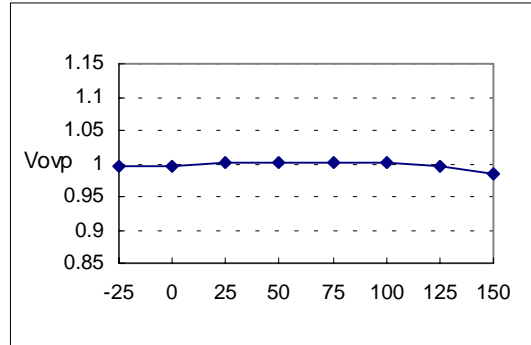

Figure 12. Over Voltage Protection

typical performance characteristics (continued)

(These characteristic graphs are normalized at $T_a = 25^\circ\text{C}$)

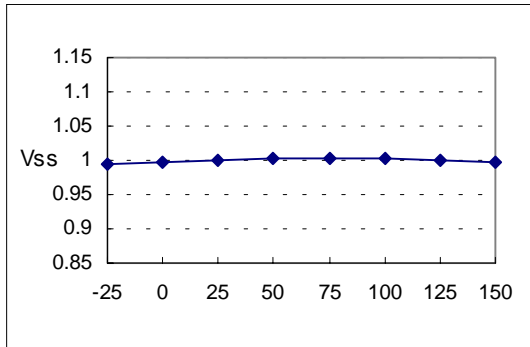

Figure 13. Soft Start Voltage

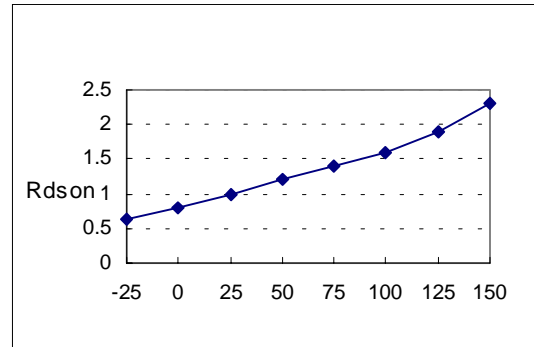
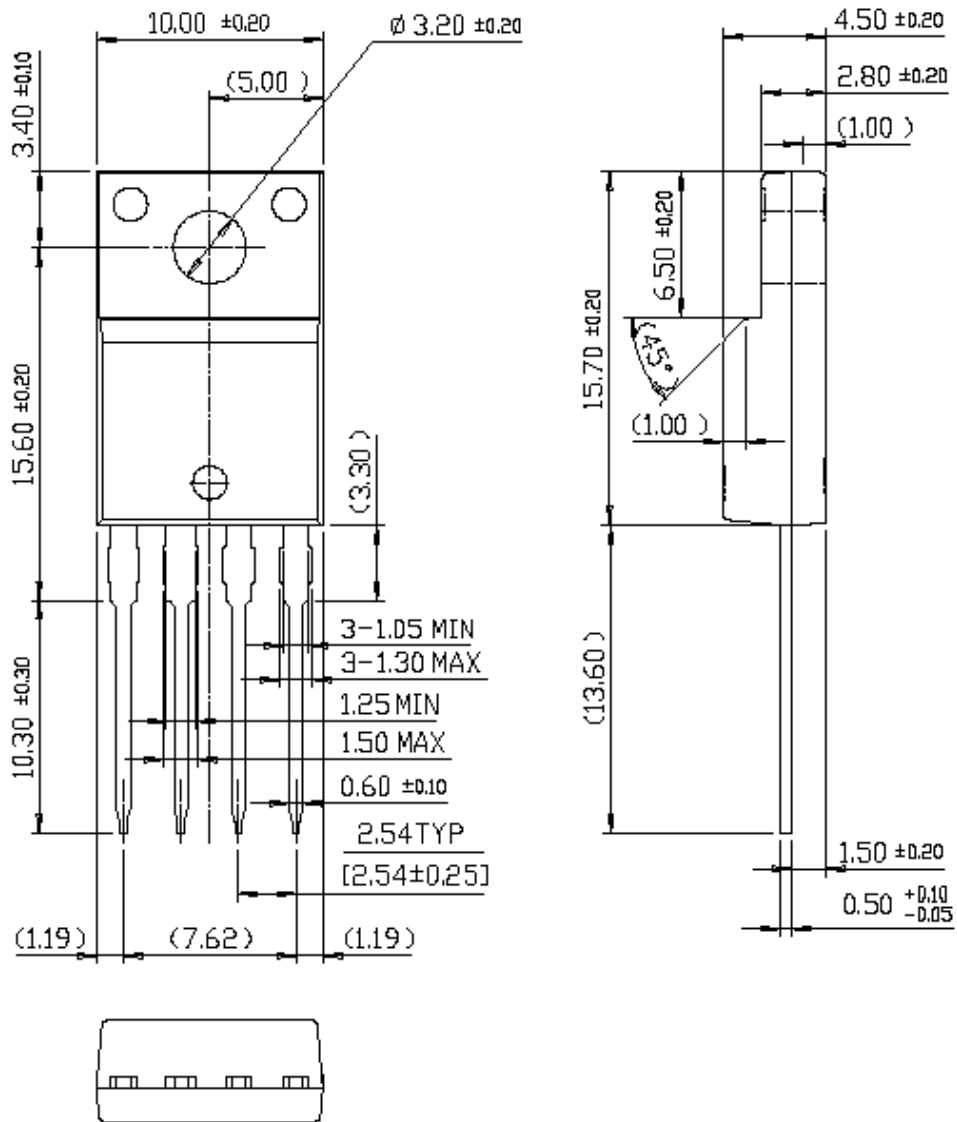

Figure 14. Drain Source Turn-on Resistance

Package Dimensions

TO-220F-4L



Package Dimensions (Continued)

TO-220F-4L (Forming)

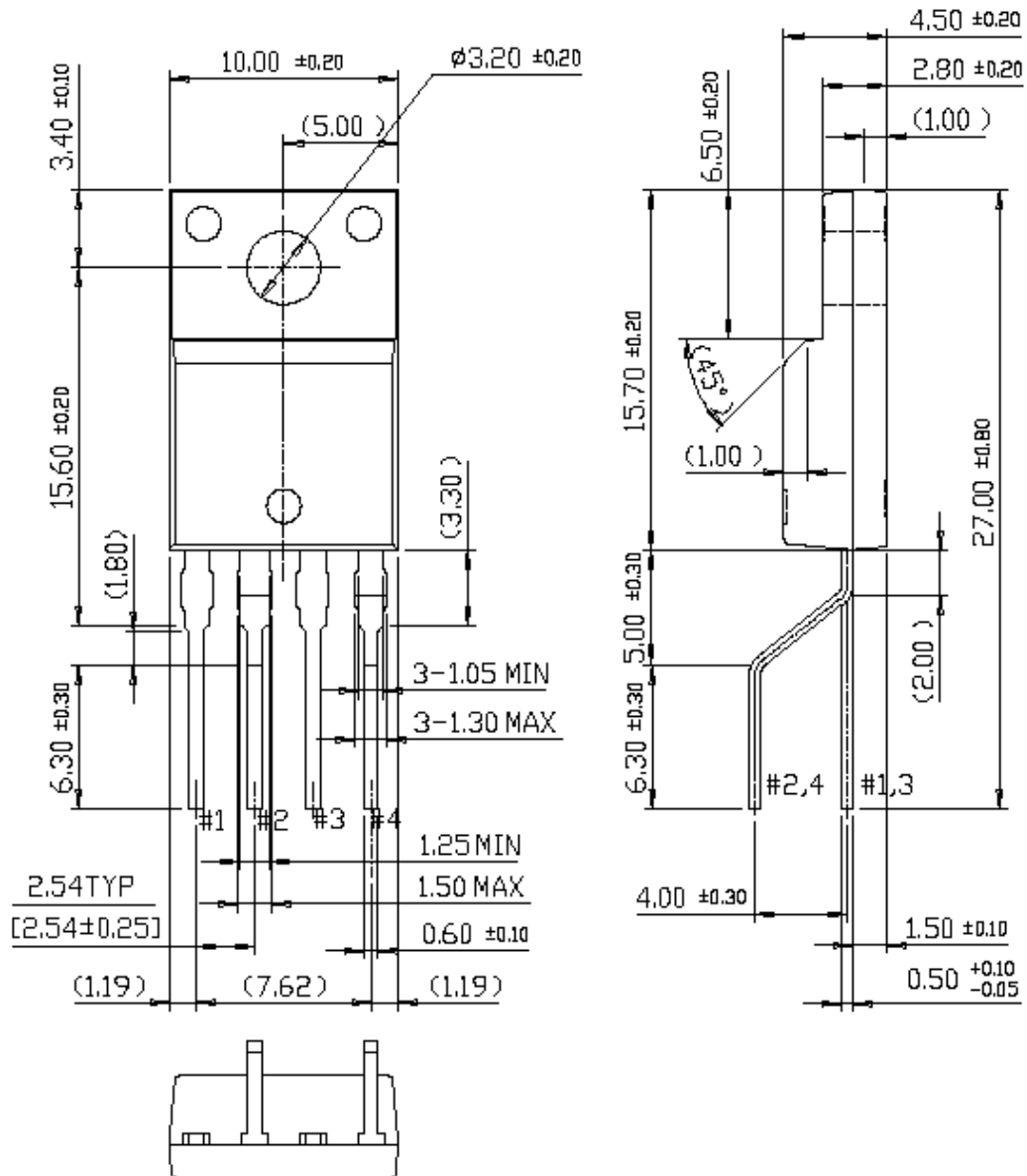

Ordering Information

Product Number	Package	Rating	Operating Temperature
KA5H0380R-TU	TO-220F-4L	800V, 3A	-25°C to +85°C
KA5H0380R-YDTU	TO-220F-4L(Forming)		
KA5M0380R-TU	TO-220F-4L	800V, 3A	-25°C to +85°C
KA5M0380R-YDTU	TO-220F-4L(Forming)		
KA5L0380R-TU	TO-220F-4L	800V, 3A	-25°C to +85°C
KA5L0380R-YDTU	TO-220F-4L(Forming)		

TU : Non forming Type

YDTU :forming Type

LIFE SUPPORT POLICY

FAIRCHILD'S PRODUCTS ARE NOT AUTHORIZED FOR USE AS CRITICAL COMPONENTS IN LIFE SUPPORT DEVICES OR SYSTEMS WITHOUT THE EXPRESS WRITTEN APPROVAL OF THE PRESIDENT OF FAIRCHILD SEMICONDUCTOR INTERNATIONAL. As used herein:

1. Life support devices or systems are devices or systems which, (a) are intended for surgical implant into the body, or (b) support or sustain life, and (c) whose failure to perform when properly used in accordance with instructions for use provided in the labeling, can be reasonably expected to result in a significant injury of the user.
2. A critical component in any component of a life support device or system whose failure to perform can be reasonably expected to cause the failure of the life support device or system, or to affect its safety or effectiveness.