



APPLICATION

This Line Output Power Transformer series has been developed to provide the required scanning amplitude and EHT for 110° 4:3 and 16:9 Colour TV's Picture Tubes operating at line frequencies of 15625Hz (Standard) or 31250Hz (HDTV).

Made in layer technology, it is suitable for high quality CTV's, home theater and multimedia applications.

The integrated focus potentiometer is internally grounded.

This series is designed in order to meet International Safety Standards.

MECHANICAL DIMENSIONS (mm)

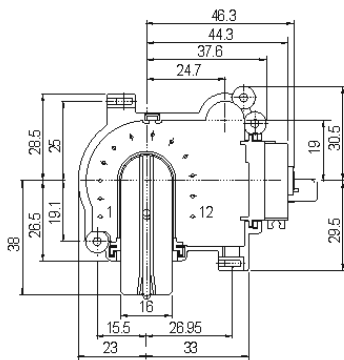

FOOTPRINT (copper side)

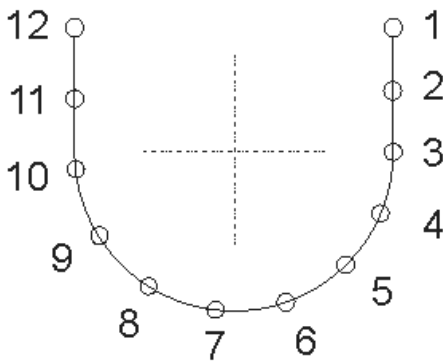

PACKAGING (single box)



WxLxH (mm) 88x74x156

SCHEMATIC DIAGRAM

1302.0042

