



**APPLICATION**

This Line Output Power Transformer series has been developed to provide the required scanning amplitude and EHT for the top 90° CTV's and the full range of 110° CTV's up to 29" screen size. The external connections are made via 12 pins which are directly solderable to the PCB.

The integrated bleeder resistor guarantees a quick discharge of the CRT and gives better performances of the HV regulation.

The integrated focus potentiometer is internally connected to ground.

This series is designed in order to meet International Safety Standards.

**MECHANICAL DIMENSIONS (mm)**

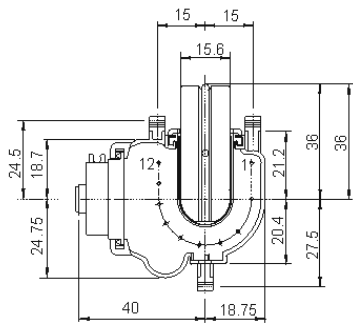

**FOOTPRINT (copper side)**

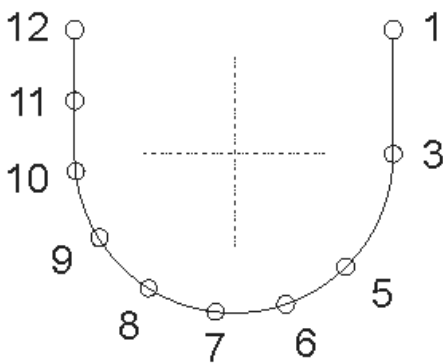

**PACKAGING (single box)**



WxLxH (mm) 100x60x128

**SCHEMATIC DIAGRAM**

1352.5095

