

2029A

PNP Epitaxial Planar  
Silicon Composite Transistor

T-29-27

# Differential Amp Applications

©957C

## Applications

- . Differential amp, current mirror, temperature compensator.

## Features

- . Excellent in thermal equilibrium and suited for use in differential amp applications.
- . Matched pair capability.

## Absolute Maximum Ratings at Ta=25°C

			unit
Collector to Base Voltage	V <sub>CB0</sub>	-55	V
Collector to Emitter Voltage	V <sub>CEO</sub>	-50	V
Emitter to Base Voltage	V <sub>EBO</sub>	-5	V
Collector Current	I <sub>C</sub>	-150	mA
Peak Collector Current	i <sub>cp</sub>	-300	mA
Collector Dissipation	P <sub>C</sub>	200	mW
Total Dissipation	P <sub>T</sub>	400	mW
Junction Temperature	T <sub>j</sub>	150	°C
Storage Temperature	T <sub>stg</sub>	-55 to +150	°C

1 unit

## Electrical Characteristics at Ta=25°C

			min	typ	max	unit
Collector Cutoff Current	I <sub>CB0</sub>	V <sub>CB</sub> =-35V, I <sub>E</sub> =0			-0.1	uA
Emitter Cutoff Current	I <sub>EBO</sub>	V <sub>EB</sub> =-4V, I <sub>C</sub> =0			-0.1	uA
DC Current Gain	h <sub>FE</sub>	V <sub>CE</sub> =-6V, I <sub>C</sub> =-1mA	100*		560*	
DC Current Gain Ratio	h <sub>FE</sub> (small/large)	V <sub>CE</sub> =-6V, I <sub>C</sub> =-1mA	0.85	0.98		

Continued on next page.

\*:The 2SA1237 is classified by h<sub>FE</sub> (small) as follows:

100	E	200	160	F	320	280	G	560
-----	---	-----	-----	---	-----	-----	---	-----

The 2SA1237 is provided with a surface mounted package.

Case Outline 2029A  
(unit:mm)

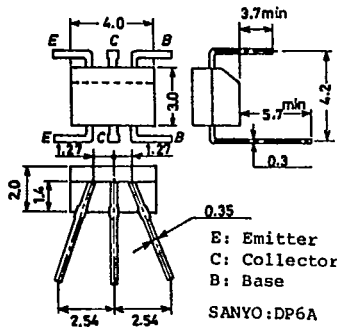

Case Outline 2030A  
(unit:mm)

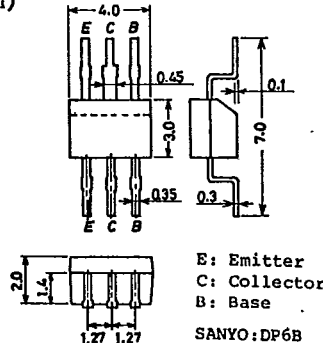

2SA1237

T-29-27

Continued from preceding page.

			min	typ	max	unit
Base to Emitter Voltage Drop	$V_{BE(large-small)}$	$V_{CE}=-6V, I_C=-1mA$		1.0	10	mV
Collector to Emitter Saturation Voltage	$V_{CE(sat)}$	$I_C=-50mA, I_B=-5mA$			-0.5	V
Gain-Bandwidth Product	$f_T$	$V_{CE}=-6V, I_C=-1mA$		100		MHz
Output Capacitance	$c_{ob}$	$V_{CB}=-10V, f=1MHz$		5.0		pF
Collector to Base Breakdown Voltage	$V_{(BR)CBO}$	$I_C=-10\mu A, I_E=0$	-55			V
Collector to Emitter Breakdown Voltage	$V_{(BR)CEO}$	$I_C=-1mA, R_{BE}=\infty$	-50			V
Emitter to Base Breakdown Voltage	$V_{(BR)EBO}$	$I_E=-10\mu A, I_C=0$	-5			V

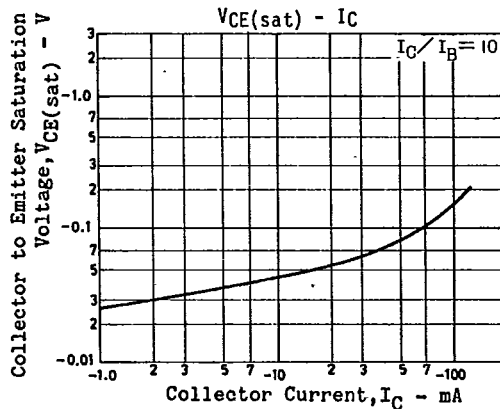
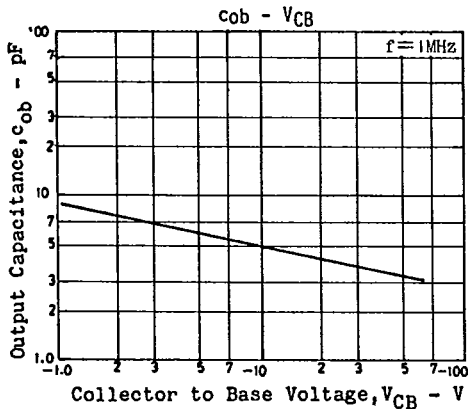
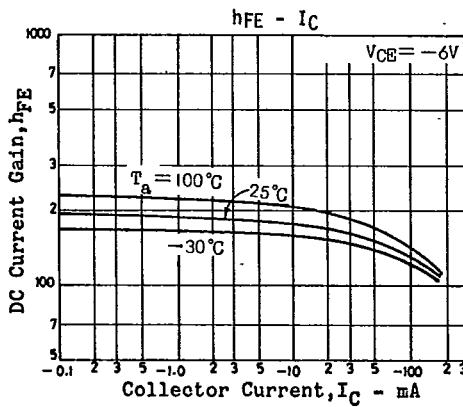
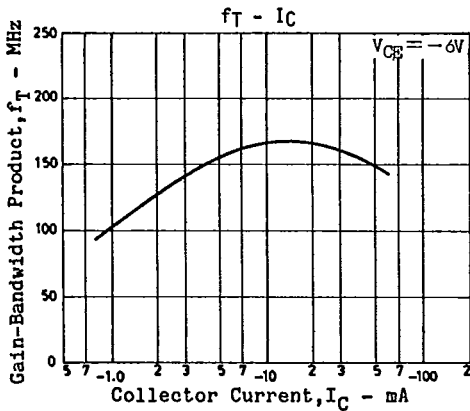
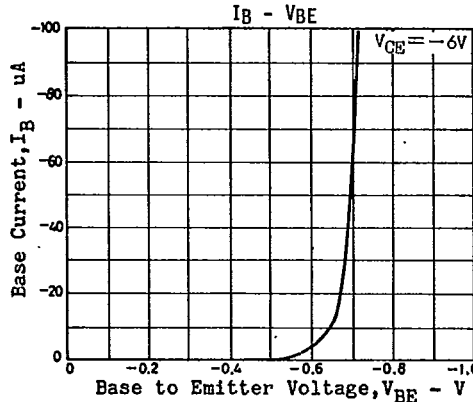
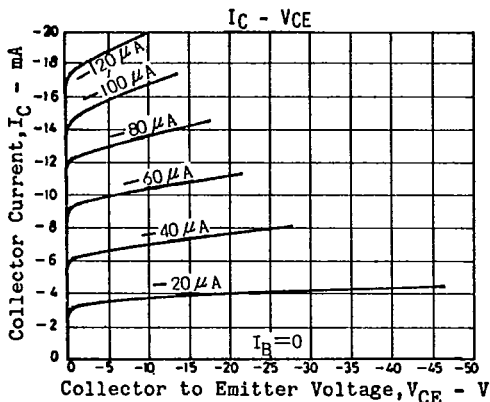

2SA1237

T-29-27

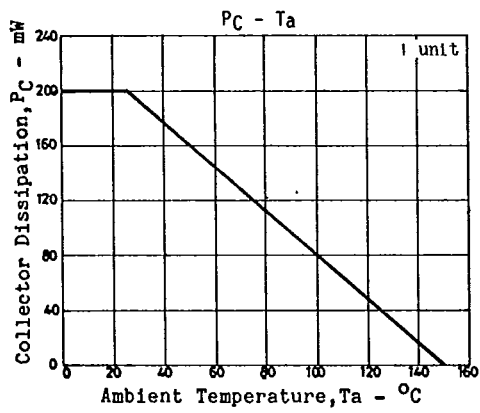

T-91-20

# CASE OUTLINES OF LEAD FORMED SMALL SIGNAL TRANSISTORS

- All of Sanyo lead formed small signal transistor case outlines are illustrated below.
- All dimensions are in mm, and dimensions which are not followed by min. or max. are represented by typical values.
- No marking is indicated.

Case Outline-[2003A] unit: mm

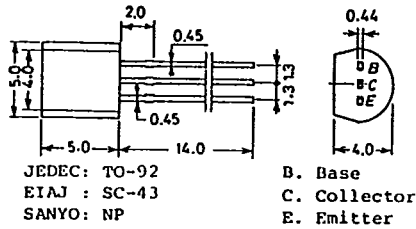

Case Outline-[2019A] unit: mm

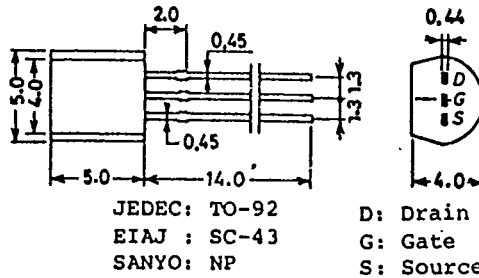

Case Outline-[2004A] unit: mm

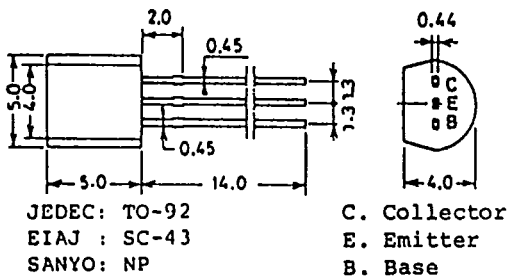

Case Outline-[2025] unit: mm

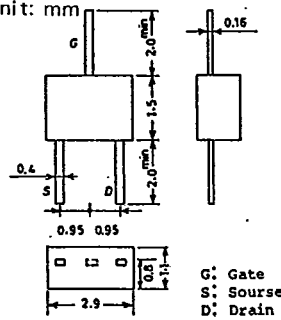

Case Outline-[2005A] unit: mm

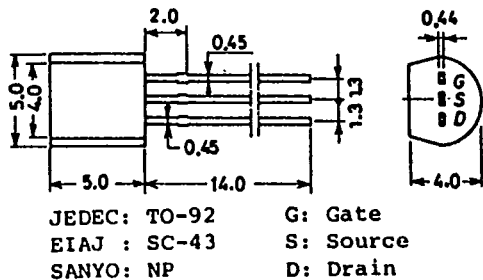

Case Outline-[2026] unit: mm

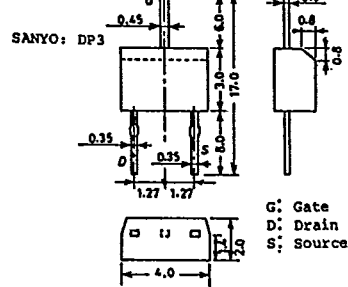

Case Outline-[2006A] unit: mm

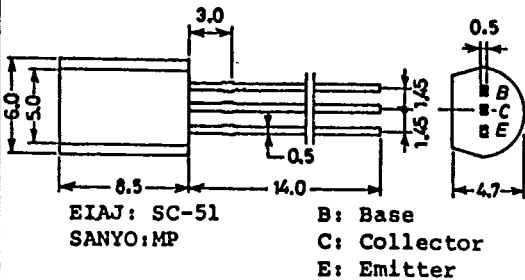

Case Outline-[2027A] unit: mm

