

# 2SB1398

## Silicon PNP epitaxial planer type

For low-frequency output amplification

### Features

- Low collector to emitter saturation voltage  $V_{CE(sat)}$ .
- Large collector current  $I_C$ .
- Allowing supply with the radial taping.

### Absolute Maximum Ratings (Ta=25°C)

Parameter	Symbol	Ratings	Unit
Collector to base voltage	$V_{CBO}$	-30	V
Collector to emitter voltage	$V_{CEO}$	-25	V
Emitter to base voltage	$V_{EBO}$	-7	V
Peak collector current	$I_{CP}$	-8	A
Collector current	$I_C$	-5	A
Collector power dissipation	$P_C^*$	1	W
Junction temperature	$T_j$	150	°C
Storage temperature	$T_{stg}$	-55 ~ +150	°C

\* Printed circuit board: Copper foil area of 1cm<sup>2</sup> or more, and the board thickness of 1.7mm for the collector portion

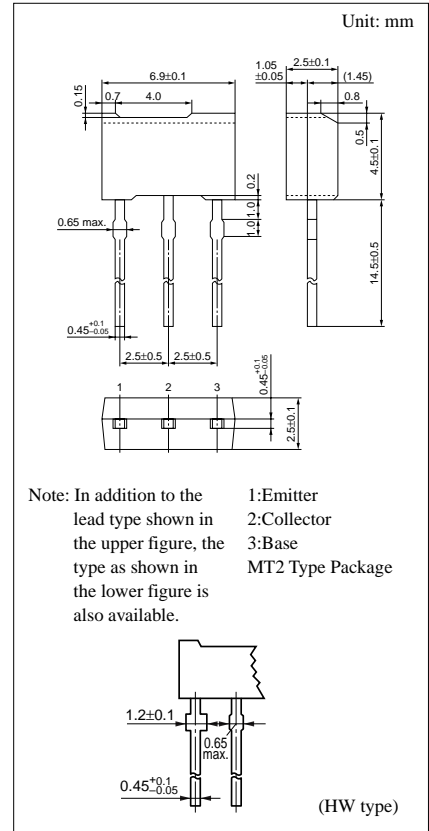

### Electrical Characteristics (Ta=25°C)

Parameter	Symbol	Conditions	min	typ	max	Unit
Collector cutoff current	$I_{CBO}$	$V_{CB} = -10V, I_E = 0$			-100	nA
Emitter cutoff current	$I_{EBO}$	$V_{EB} = -5V, I_C = 0$			-100	nA
Collector to emitter voltage	$V_{CEO}$	$I_C = -1mA, I_B = 0$	-25			V
Emitter to base voltage	$V_{EBO}$	$I_E = -10\mu A, I_C = 0$	-7			V
Forward current transfer ratio	$h_{FE}^{*1}$	$V_{CE} = -2V, I_C = -2A^{*2}$	90		205	
Collector to emitter saturation voltage	$V_{CE(sat)}$	$I_C = -3A, I_B = -0.1A^{*2}$			-1	V
Transition frequency	$f_T$	$V_{CB} = -6V, I_E = 50mA, f = 200MHz$		120		MHz
Collector output capacitance	$C_{ob}$	$V_{CB} = -20V, I_E = 0, f = 1MHz$			85	pF

<sup>\*2</sup> Pulse measurement

<sup>\*1</sup> $h_{FE}$  Rank classification

Rank	P	Q
$h_{FE}$	90 ~ 135	120 ~ 205

$P_C - T_a$

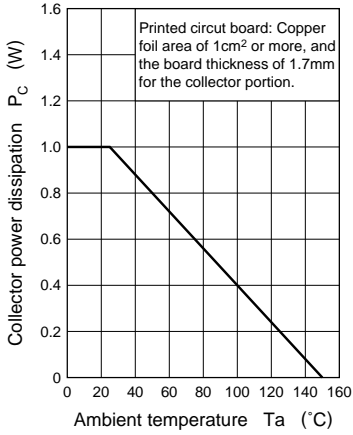

$I_C - V_{CE}$

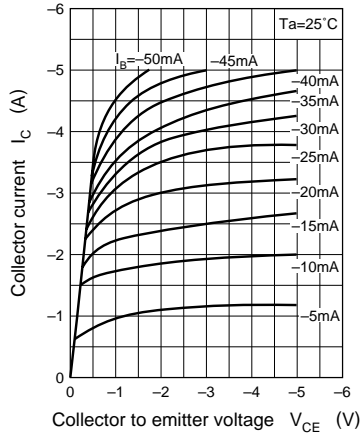

$I_C - V_{BE}$

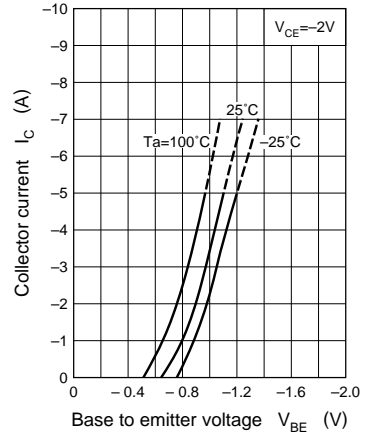

$h_{FE} - I_C$

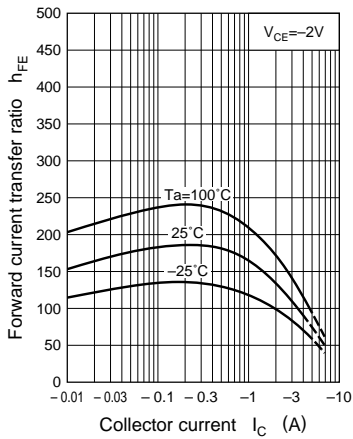

$V_{CE(sat)} - I_C$

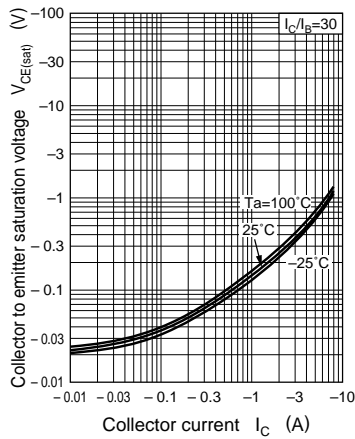

$f_T - I_E$

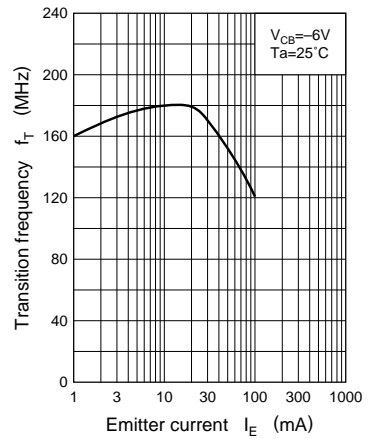

$C_{ob} - V_{CB}$

