

Silicon NPN Epitaxial Planar Transistor (Complement to type 2SA1294)

Application : Audio and General Purpose

Absolute maximum ratings (Ta=25°C)

Symbol	2SC3263	Unit
V _{CB0}	230	V
V _{CEO}	230	V
V _{EBO}	5	V
I _C	15	A
I _B	4	A
P _C	130(T _C =25°C)	W
T _J	150	°C
T _{stg}	-55 to +150	°C

Electrical Characteristics (Ta=25°C)

Symbol	Conditions	2SC3263	Unit
I _{CB0}	V _{CB} =230V	100max	μA
I _{EBO}	V _{EB} =5V	100max	μA
V _{(BR)CEO}	I _C =25mA	230min	V
h _{FE}	V _{CE} =4V, I _C =5A	50min*	
V _{CE(sat)}	I _C =5A, I _B =0.5A	2.0max	V
f _r	V _{CE} =12V, I _E =-2A	60typ	MHz
COB	V _{CB} =10V, f=1MHz	250typ	pF

*h_{FE} Rank \bar{O} (50 to 100), Y(70 to 140)

Typical Switching Characteristics (Common Emitter)

V _{CC} (V)	R _L (Ω)	I _C (A)	V _{BB1} (V)	V _{BB2} (V)	I _{B1} (mA)	I _{B2} (mA)	t _{on} (μs)	t _{stg} (μs)	t _f (μs)
60	12	5	10	-5	500	-500	0.30typ	2.40typ	0.50typ

External Dimensions MT-100(TO3P)

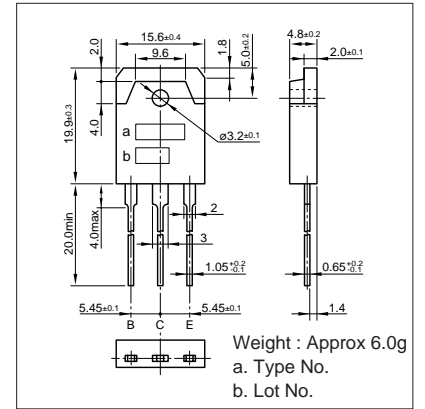

I_C-V_{CE} Characteristics (Typical)

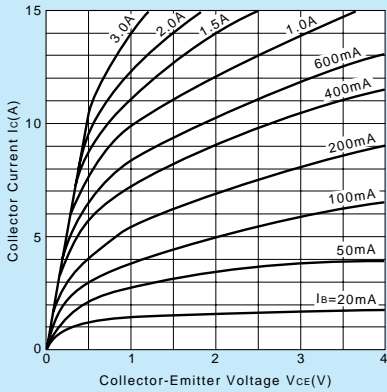

V_{CE(sat)}-I_B Characteristics (Typical)

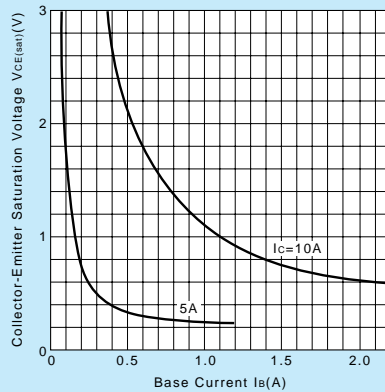

I_C-V_{BE} Temperature Characteristics (Typical)

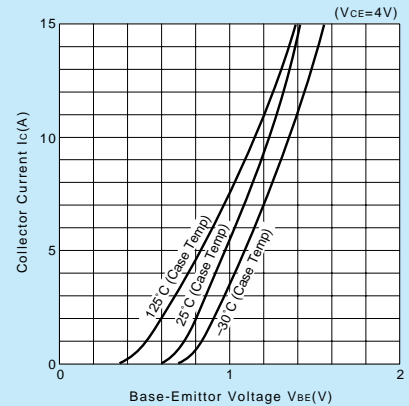

h_{FE}-I_C Characteristics (Typical)

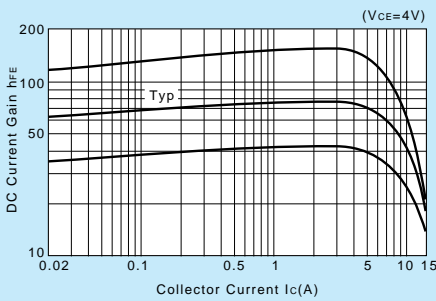

h_{FE}-I_C Temperature Characteristics (Typical)

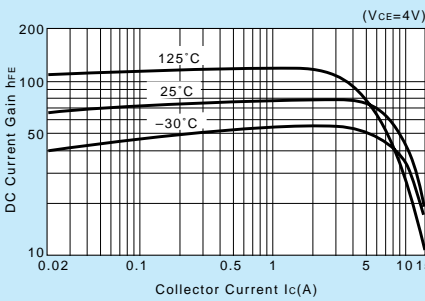

θ_{J-a}-t Characteristics

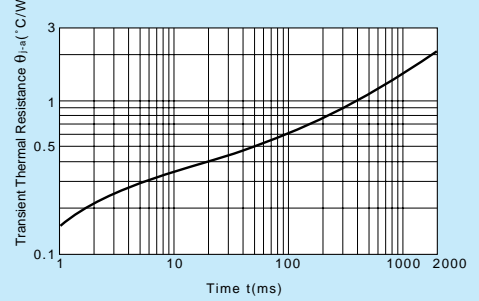

f_T-I_E Characteristics (Typical)

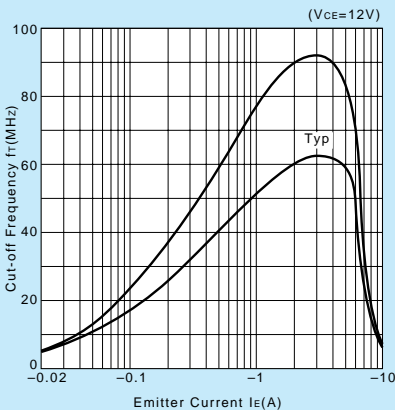

Safe Operating Area (Single Pulse)

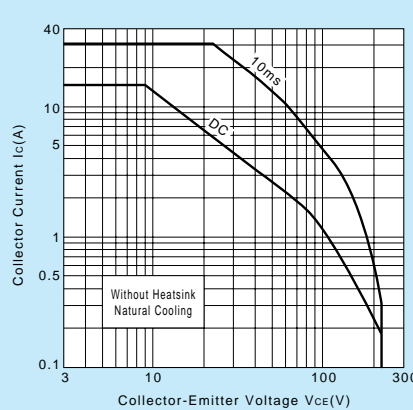

P_C-T_a Derating

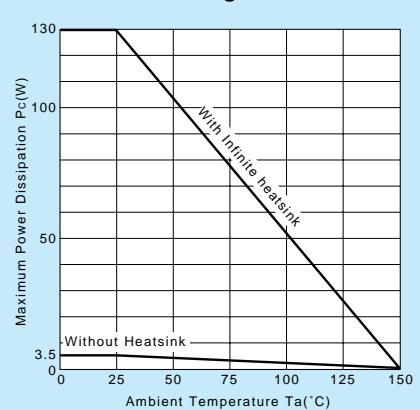

This datasheet has been downloaded from:

www.DatasheetCatalog.com

Datasheets for electronic components.